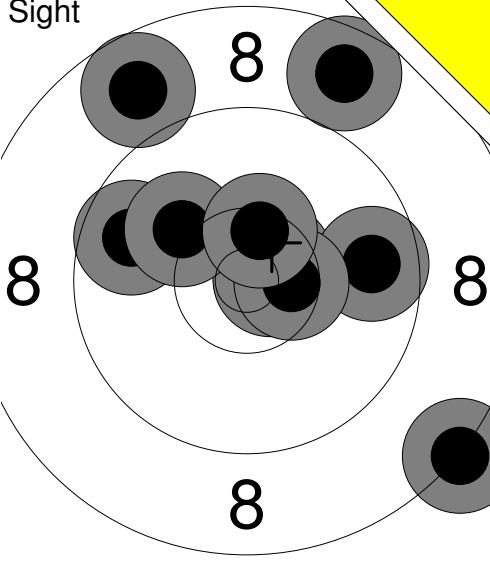
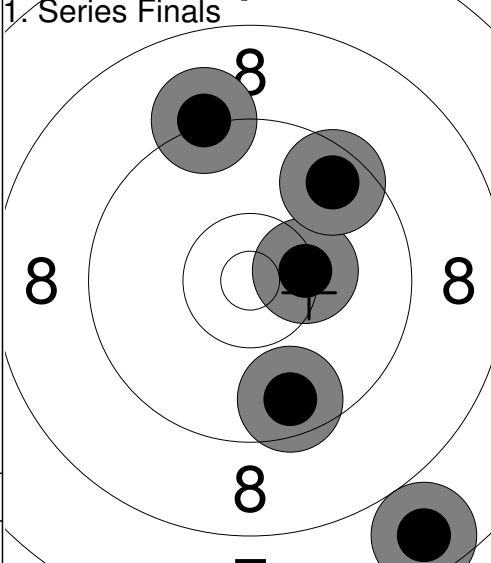
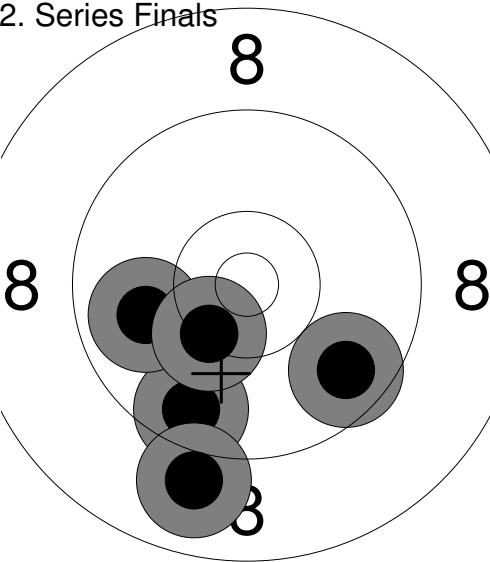
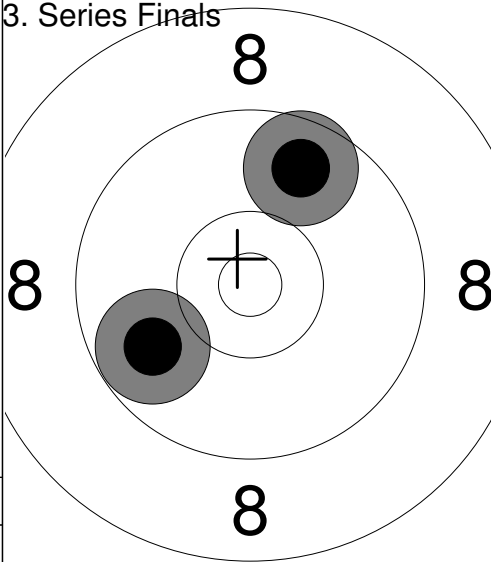
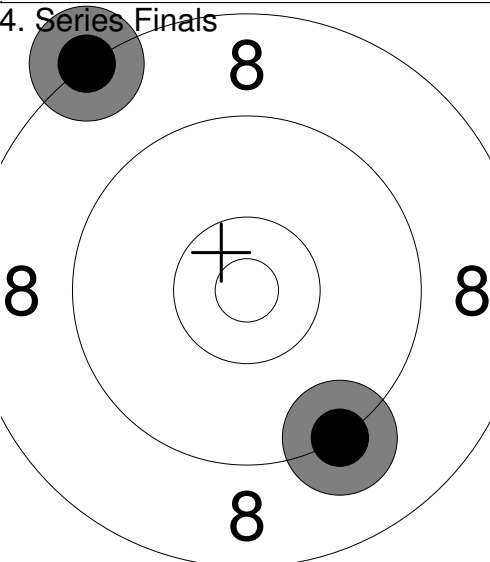
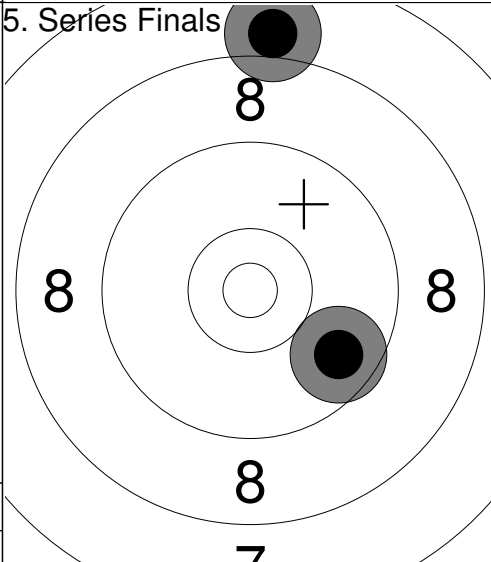

Relay 1	Lane 3	WANG Hejia (zack)		
2023 AHA Memorial		BC	F	MP
18.11.2023		Event name 65		Alberta Handgun Association
Comment		Signature		

Sight 	1: 10.6x ↗	1. Series Finals 	1: 10.4 →
	2: 10.7x →		2: 9.2 ↑
	3: 8.8 ↑		3: 9.6 ↗
	4: 9.7 →		4: 7.7 ↘
	5: 8.7 ↑		5: 9.6 ↘
	6: 8.2 ↘		
	7: 9.7 ←		
	8: 10.1 ↗		
	9: 10.5x →		
	10: 10.4x ↑		
	Series 97.4		Series 46.5
	0.0		46.5
2. Series Finals 	1: 9.7 ↘	3. Series Finals 	1: 9.8 ↙
	2: 9.6 ↘		2: 9.7 ↑
	3: 9.9 ←		
	4: 9.0 ↘		
	5: 10.3 ↘		
	Series 48.5		Series 19.5
	95.0		114.5
4. Series Finals 	1: 9.2 ↘	5. Series Finals 	1: 9.7 ↘
	2: 8.2 ↑		2: 8.0 ↑
	Series 17.4		Series 17.7
	131.9		149.6

Relay 1	Lane 4	<h1>NORMAN Seth</h1>
-------------------	------------------	----------------------

2023 AHA Memorial	SK	F	MP
-------------------	----	---	----

18.11.2023	Event name 65	Alberta Handgun Association
------------	---------------	-----------------------------

Comment	Signature
---------	-----------

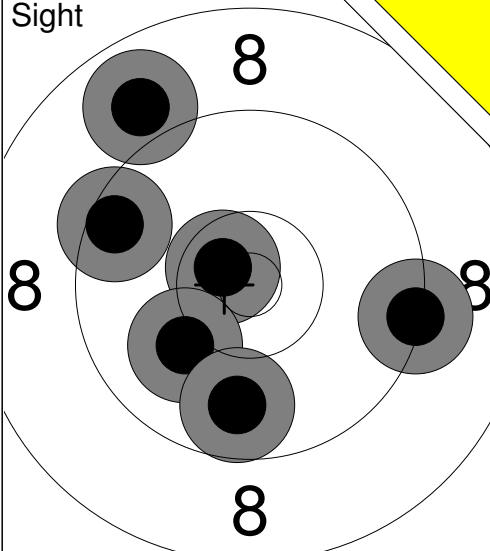
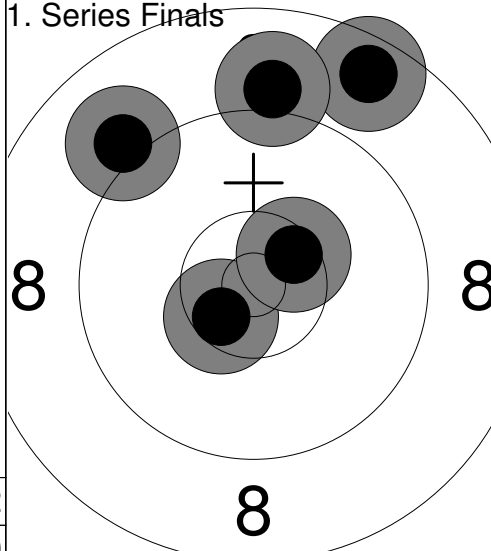
<p>Sight</p> 	<p>1. Series Finals</p> 	<p>1: 8.9 ↗ 2: 9.3 → 3: 10.6x ↗ 4: 9.5 ↗ 5: 10.1 ↙ 6: 9.8 ↓</p> <p>Series 58.2 0.0</p>	<p>1: 8.6 ↗ 2: 10.5x ↙ 3: 9.1 ↖ 4: 9.0 ↑ 5: 10.5x ↗</p> <p>Series 47.7 47.7</p>
---	--	--	---

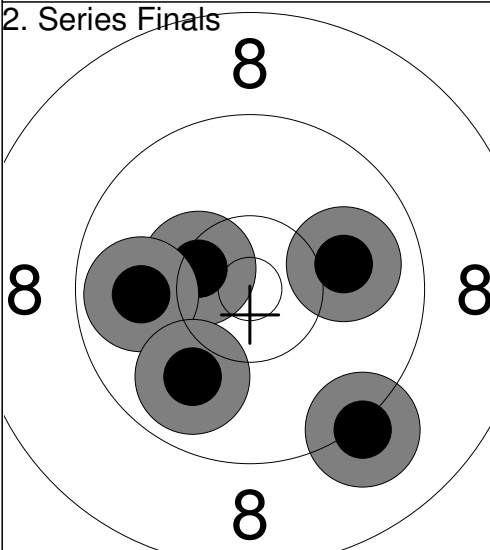
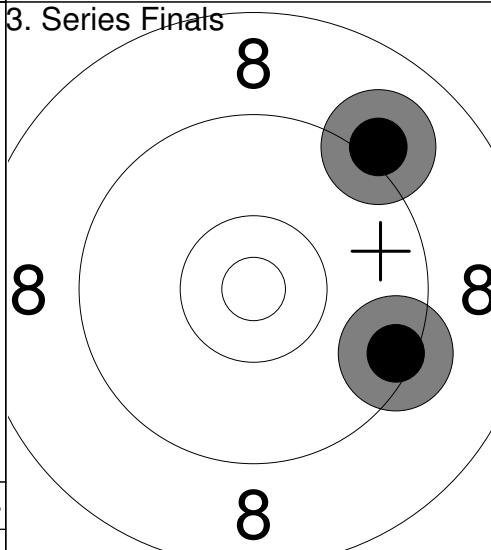
<p>2. Series Finals</p> 	<p>3. Series Finals</p> 	<p>1: 10.4x ↖ 2: 9.9 ← 3: 10.0 → 4: 9.9 ↙ 5: 9.2 ↓</p> <p>Series 49.4 97.1</p>	<p>1: 9.4 ➤ 2: 9.1 ↗</p> <p>Series 18.5 115.6</p>
---	---	--	---

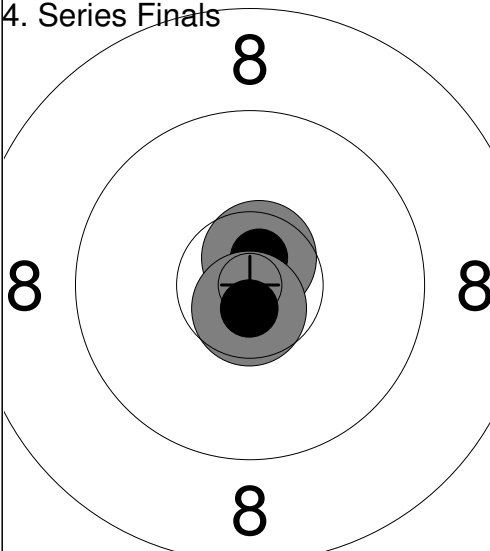
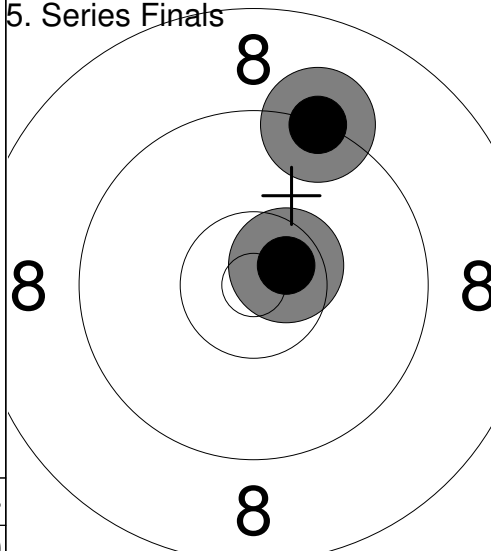
<p>4. Series Finals</p> 	<p>5. Series Finals</p> 	<p>1: 10.7x ↑ 2: 10.7x ↓</p> <p>Series 21.4 137.0</p>	<p>1: 9.3 ↗ 2: 10.6x ↗</p> <p>Series 19.9 156.9</p>
--	--	---	---

6. Series Finals /

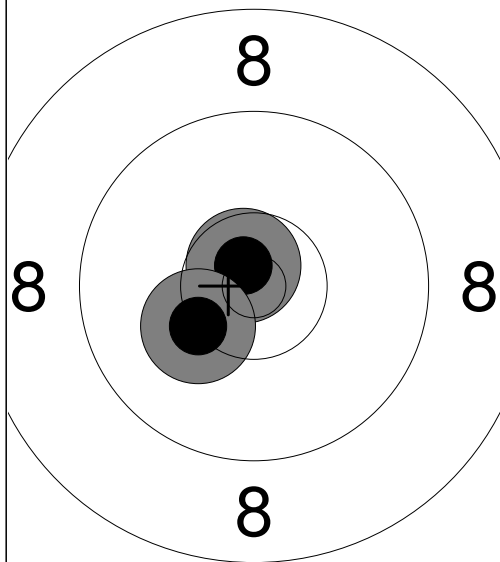

1: 10.7x ↗
2: 10.3 ↙

Series 21.0
177.9

7. Series Finals /

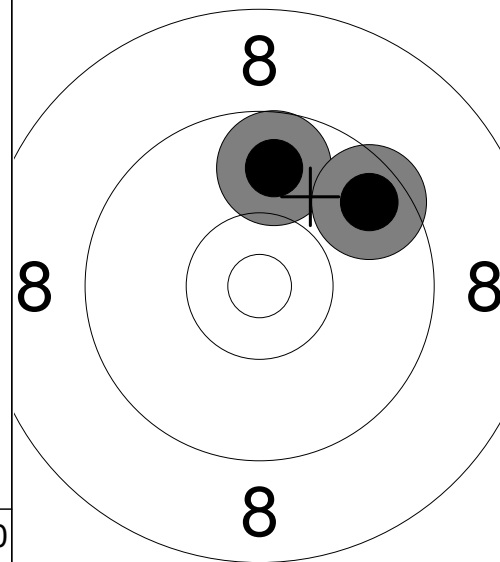

1: 9.8 ↑
2: 9.6 ↗

Series 19.4
197.3

8. Series Finals /

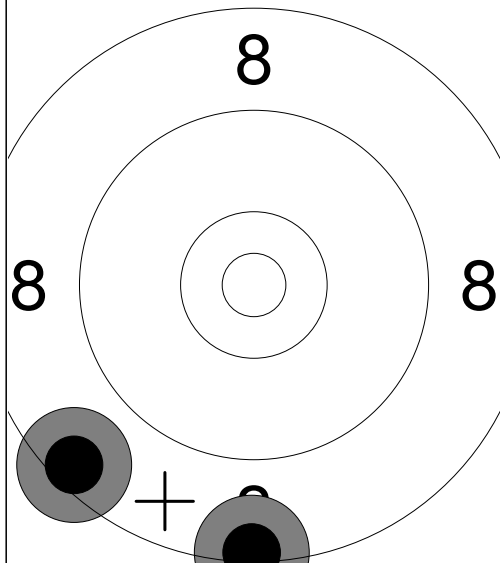

1: 8.4 ↙
2: 8.3 ↓

Series 16.7
214.0

9. Series Finals /

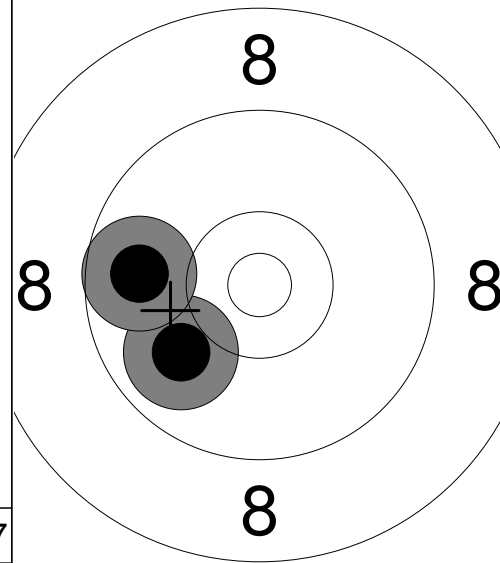

1: 9.9 ↙
2: 9.8 ←

Series 19.7
233.7

Relay 1	Lane 5	OLSEN Jesse
-------------------	------------------	--------------------

2023 AHA Memorial	SK	F	MP
-------------------	----	---	----

18.11.2023	Event name 65	Alberta Handgun Association
------------	---------------	-----------------------------

Comment	Signature
---------	-----------

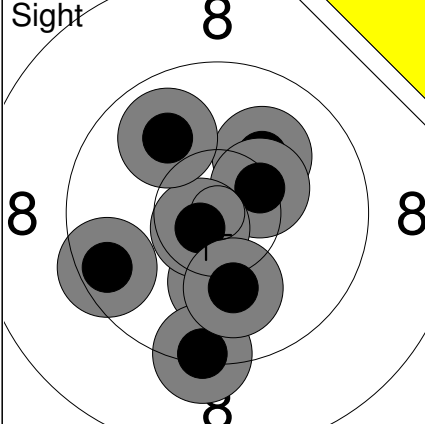
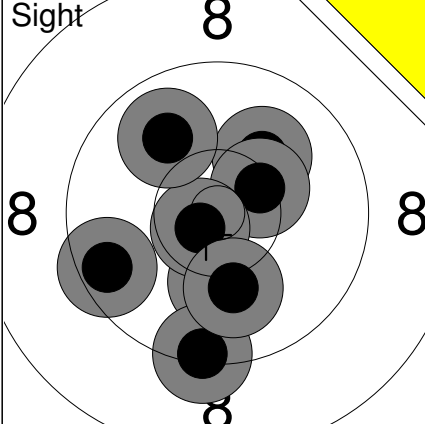
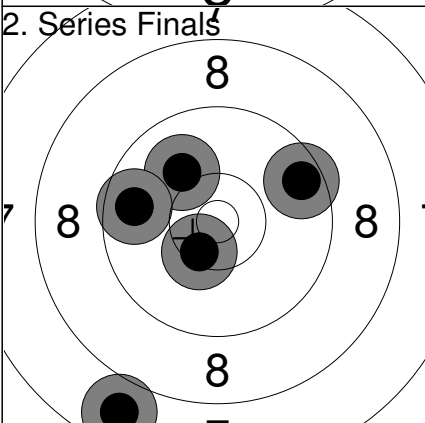
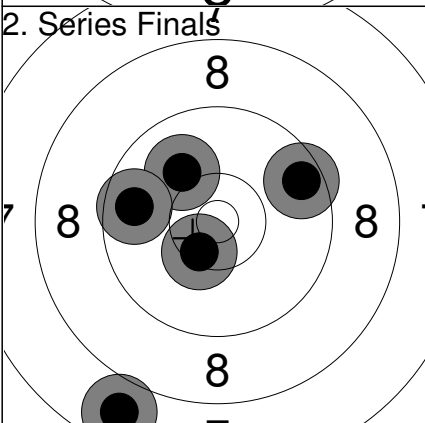
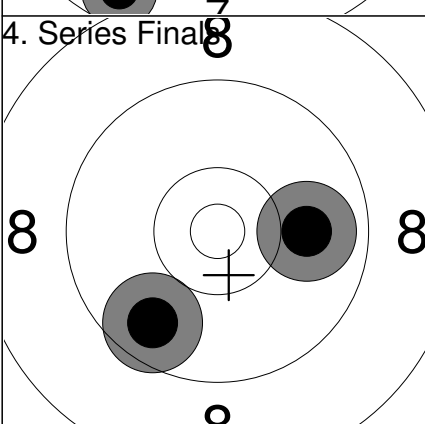
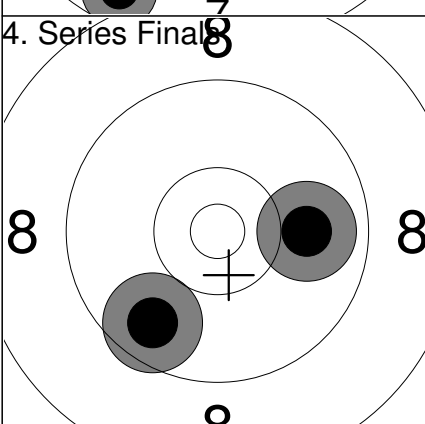
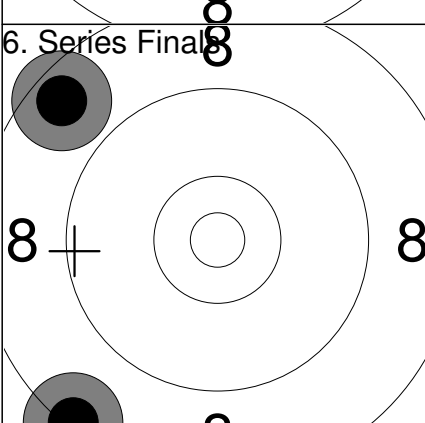
<p>Sight</p> 	<p>1: 10.1 ↗ 2: 10.4x → 3: 10.2 ↓ 4: 9.6 ← 5: 10.7x ↙ 6: 9.9 ↗ 7: 9.3 ↓ 8: 10.1 ↓</p>	<p>1. Series Finals</p> 	<p>1: 9.9 ← 2: 10.7x ↓ 3: 8.9 ↙ 4: 10.0 → 5: 8.5 ←</p>								
<table style="width:100%; border-collapse: collapse;"> <tr> <td style="width:50%;">Series</td> <td style="text-align: right;">80.3</td> </tr> <tr> <td></td> <td style="text-align: right;">0.0</td> </tr> </table>		Series	80.3		0.0	<table style="width:100%; border-collapse: collapse;"> <tr> <td style="width:50%;">Series</td> <td style="text-align: right;">48.0</td> </tr> <tr> <td></td> <td style="text-align: right;">48.0</td> </tr> </table>		Series	48.0		48.0
Series	80.3										
	0.0										
Series	48.0										
	48.0										
<p>2. Series Finals</p> 	<p>1: 9.6 → 2: 10.4x ↓ 3: 10.0 ↗ 4: 9.7 ← 5: 7.8 ↓</p>	<p>3. Series Finals</p> 	<p>1: 9.2 ↙ 2: 10.4x →</p>								
<table style="width:100%; border-collapse: collapse;"> <tr> <td style="width:50%;">Series</td> <td style="text-align: right;">47.5</td> </tr> <tr> <td></td> <td style="text-align: right;">95.5</td> </tr> </table>		Series	47.5		95.5	<table style="width:100%; border-collapse: collapse;"> <tr> <td style="width:50%;">Series</td> <td style="text-align: right;">19.6</td> </tr> <tr> <td></td> <td style="text-align: right;">115.1</td> </tr> </table>		Series	19.6		115.1
Series	47.5										
	95.5										
Series	19.6										
	115.1										
<p>4. Series Finals</p> 	<p>1: 9.7 ↙ 2: 9.9 →</p>	<p>5. Series Finals</p> 	<p>1: 9.3 ← 2: 9.2 ↓</p>								
<table style="width:100%; border-collapse: collapse;"> <tr> <td style="width:50%;">Series</td> <td style="text-align: right;">19.6</td> </tr> <tr> <td></td> <td style="text-align: right;">134.7</td> </tr> </table>		Series	19.6		134.7	<table style="width:100%; border-collapse: collapse;"> <tr> <td style="width:50%;">Series</td> <td style="text-align: right;">18.5</td> </tr> <tr> <td></td> <td style="text-align: right;">153.2</td> </tr> </table>		Series	18.5		153.2
Series	19.6										
	134.7										
Series	18.5										
	153.2										
<p>6. Series Finals</p> 	<p>1: 8.6 ↖ 2: 8.3 ↙</p>										
<table style="width:100%; border-collapse: collapse;"> <tr> <td style="width:50%;">Series</td> <td style="text-align: right;">16.9</td> </tr> <tr> <td></td> <td style="text-align: right;">170.1</td> </tr> </table>		Series	16.9		170.1						
Series	16.9										
	170.1										

Relay 1	Lane 6	OZER Tugrul
-------------------	------------------	--------------------

2023 AHA Memorial	AB	F	MP
-------------------	----	---	----

18.11.2023	Event name 65	Alberta Handgun Association
------------	---------------	-----------------------------

Comment	Signature
---------	-----------

<p>Sight</p>	<p>1: 10.5x ↗</p> <p>2: 10.3 ←</p> <p>3: 9.6 ↑</p> <p>4: 10.7x ↗</p> <p>5: 10.5x ➤</p> <p>6: 9.4 ↖</p> <p>7: 10.8x ➔</p> <p>8: 9.6 ↑</p> <p>9: 10.2 ↗</p> <p>10: 10.2 ➔</p>	<p>Sight</p>	<p>11: 10.5x ➤</p>
	<p>Series 101.8</p> <p>0.0</p>		<p>Series 10.5</p> <p>0.0</p>

<p>1. Series Finals</p>	<p>1: 10.0 ↙</p> <p>2: 9.8 ↘</p> <p>3: 8.9 ↗</p> <p>4: 10.0 ←</p> <p>5: 10.8x ↑</p>	<p>2. Series Finals</p>	<p>1: 8.5 ↙</p> <p>2: 9.6 ←</p> <p>3: 9.9 ↗</p> <p>4: 10.6x ➔</p> <p>5: 10.0 ↙</p>
	<p>Series 49.5</p> <p>49.5</p>		<p>Series 48.6</p> <p>98.1</p>

<p>3. Series Finals</p>	<p>1: 8.5 ➔</p> <p>2: 10.3 ↖</p>	<p>4. Series Finals</p>	<p>1: 10.9x ↑</p> <p>2: 9.3 ↗</p>
	<p>Series 18.8</p> <p>116.9</p>		<p>Series 20.2</p> <p>137.1</p>

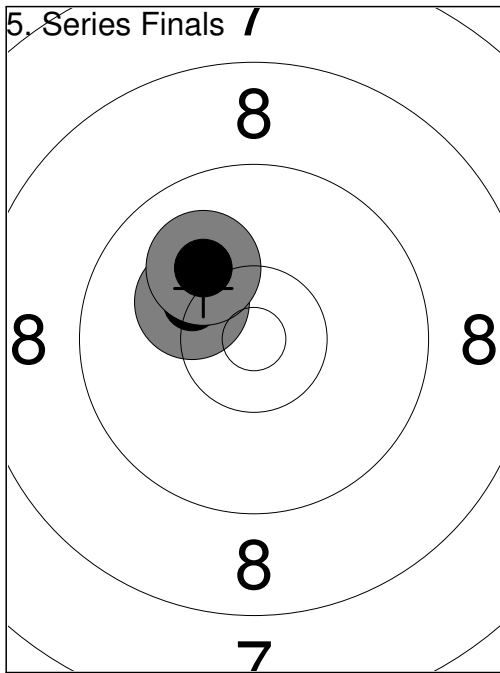

1:	10.2 ↖
2:	10.1 ↗
Series	20.3
	157.4

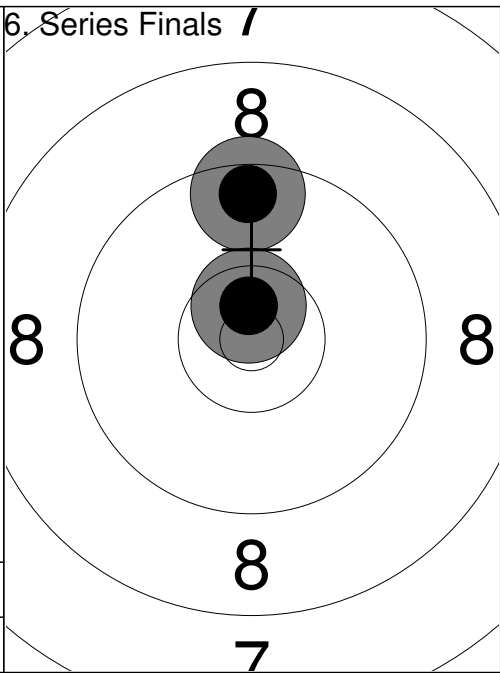

1:	9.5 ↑
2:	10.6x ↑
Series	20.1
	177.5

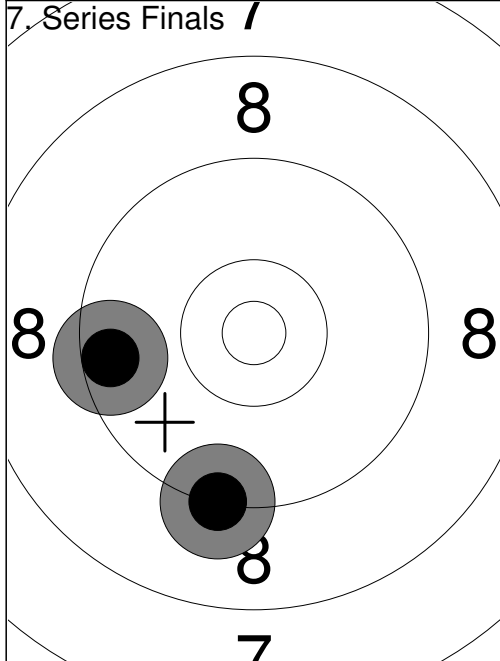

1:	9.3 ↓
2:	9.5 ←
Series	18.8
	196.3

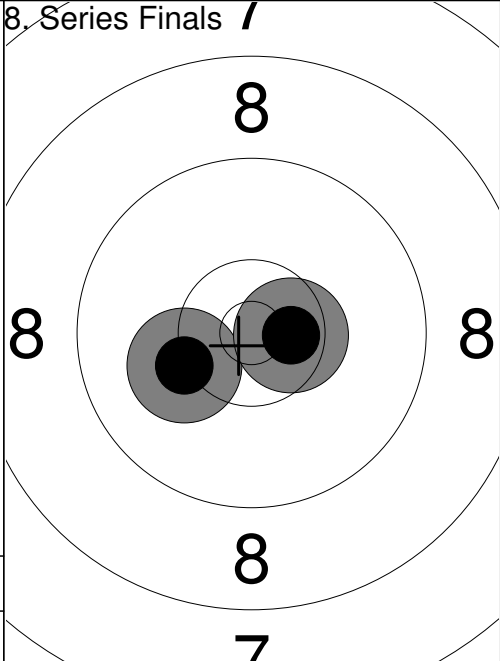

1:	10.2 ↖
2:	10.6x →
Series	20.8
	217.1

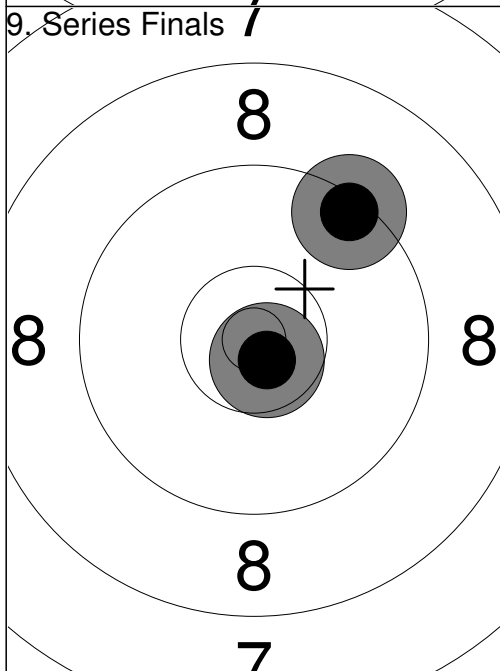

1:	9.4 ↗
2:	10.7x ↓
Series	20.1
	237.2

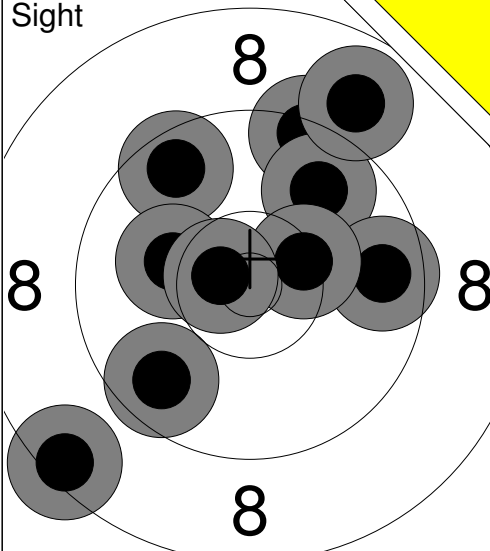
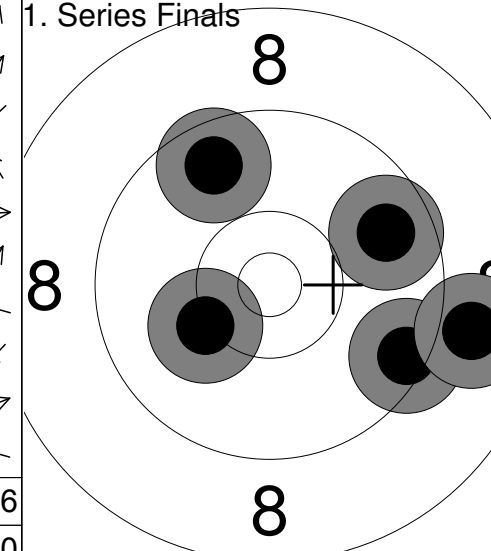
<p>Sight</p> 	<p>1: 9.4 ↗ 2: 9.8 ↗ 3: 8.4 ↙ 4: 9.6 ↗ 5: 9.6 → 6: 8.9 ↗ 7: 10.2 ← 8: 9.7 ↙ 9: 10.4x → 10: 10.6x ←</p> <p>Series 96.6 0.0</p>	<p>1. Series Finals</p>  <p>1: 9.7 → 2: 9.4 → 3: 9.7 ↗ 4: 8.9 → 5: 10.2 ←</p> <p>Series 47.9 47.9</p>
---	---	---

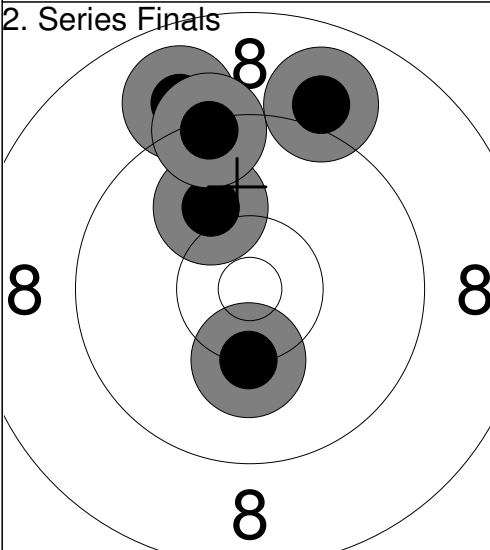
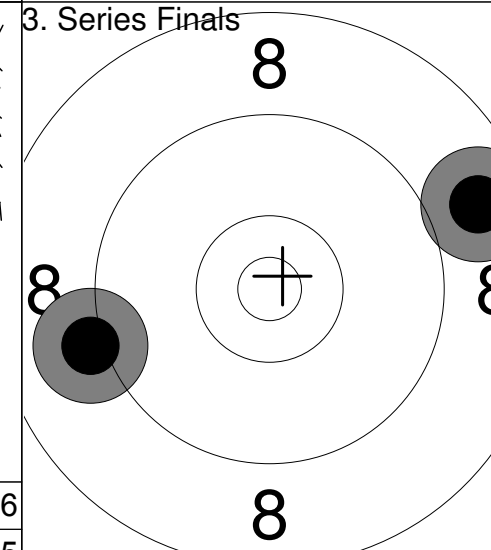
<p>2. Series Finals</p> 	<p>1: 10.2 ↓ 2: 9.0 ↗ 3: 10.1 ↗ 4: 9.3 ↗ 5: 9.0 ↗</p> <p>Series 47.6 95.5</p>	<p>3. Series Finals</p>  <p>1: 9.1 ← 2: 8.7 →</p> <p>Series 17.8 113.3</p>
---	---	---

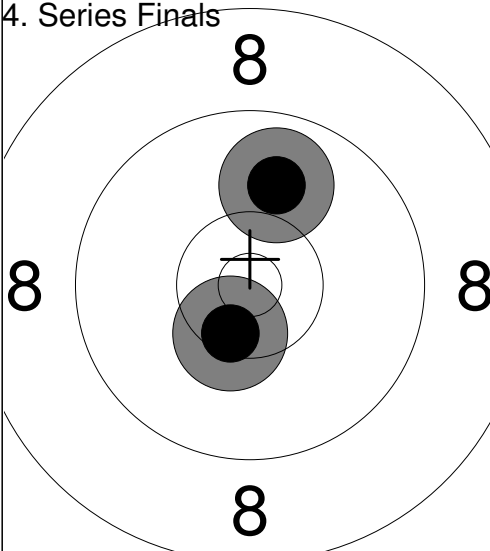
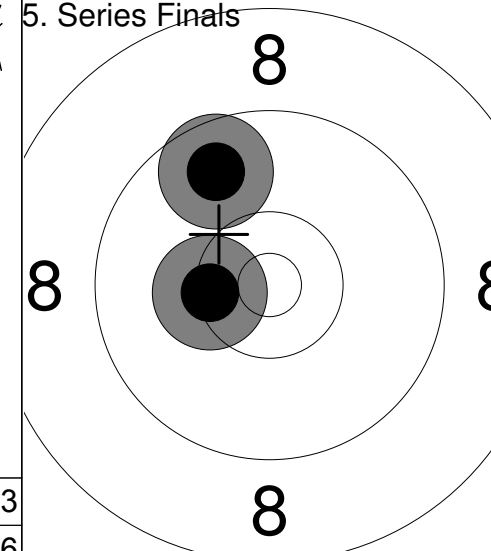
<p>4. Series Finals</p> 	<p>1: 10.4x ↙ 2: 9.9 ↗</p> <p>Series 20.3 133.6</p>	<p>5. Series Finals</p>  <p>1: 10.4 ← 2: 9.7 ↗</p> <p>Series 20.1 153.7</p>
--	---	---

6. Series Finals /

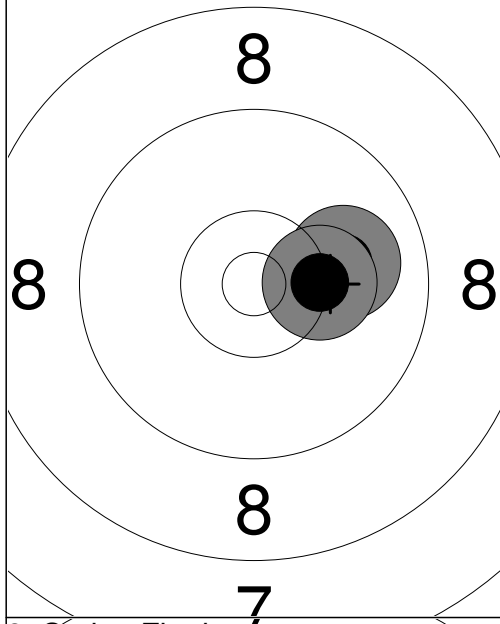

1: 10.1 →
2: 10.3 →

Series	20.4
	174.1

7. Series Finals /

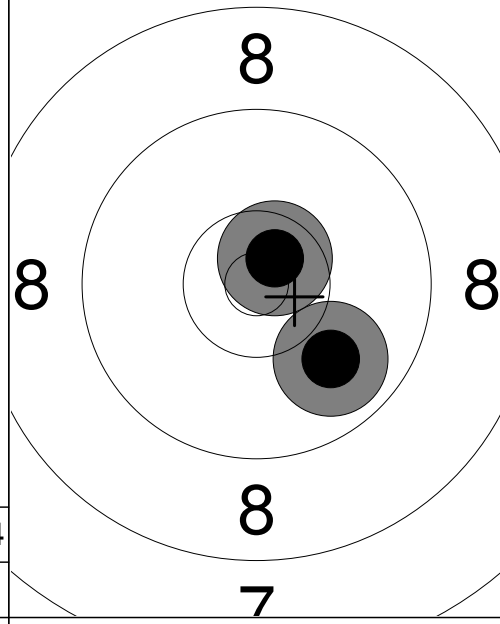

1: 9.9 ↘
2: 10.6x ↗

Series	20.5
	194.6

8. Series Finals /

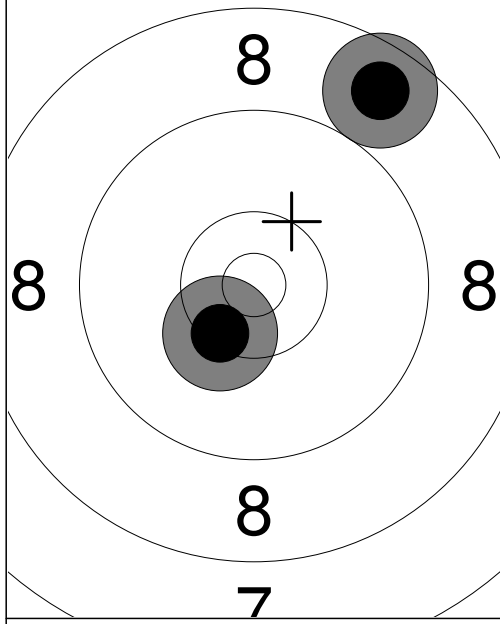

1: 10.4x ↙
2: 8.7 ↗

Series	19.1
	213.7

Relay 1	Lane 8	NEIL Jaden
-------------------	------------------	-------------------

2023 AHA Memorial	AB	F	MP
-------------------	----	---	----

18.11.2023	Event name 65	Alberta Handgun Association
------------	---------------	-----------------------------

Comment	Signature
---------	-----------

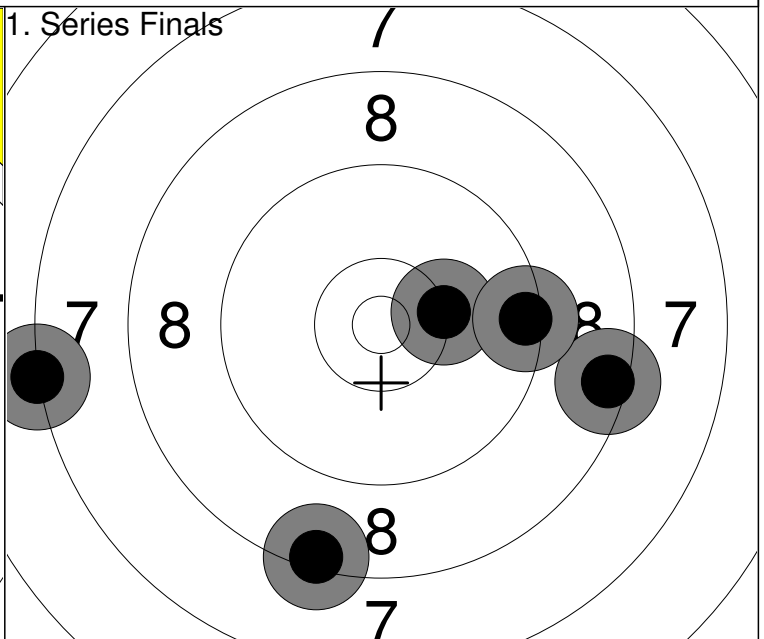
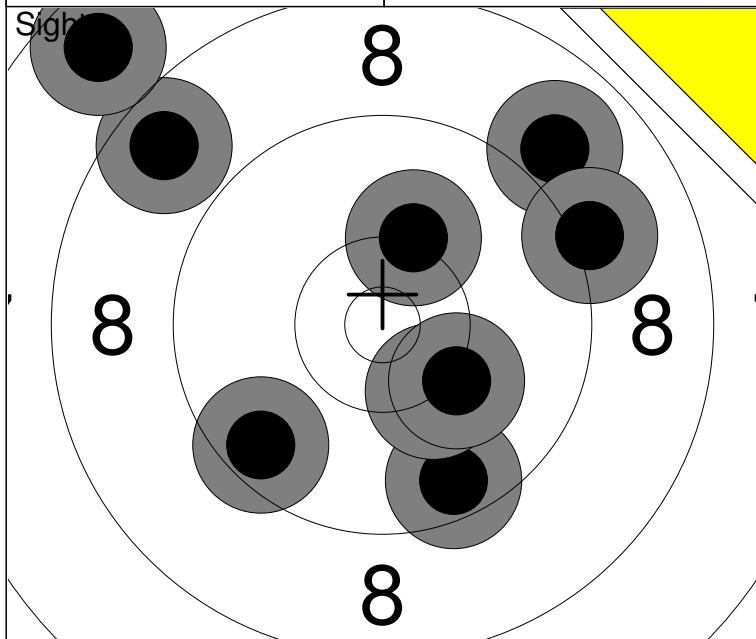

1: 9.5 ↓	6: 10.2 ↑	Series	84.0
2: 8.9 ↗	7: 7.7 ↗		
3: 10.3 ↓	8: 9.5 ↓	Series	0.0
4: 8.6 ↗	9: 10.2 ↓		
5: 9.1 →			

1: 8.4 →	Series	43.7
2: 10.3 →		
3: 9.4 →	Series	43.7
4: 7.2 ←		
5: 8.4 ↓		

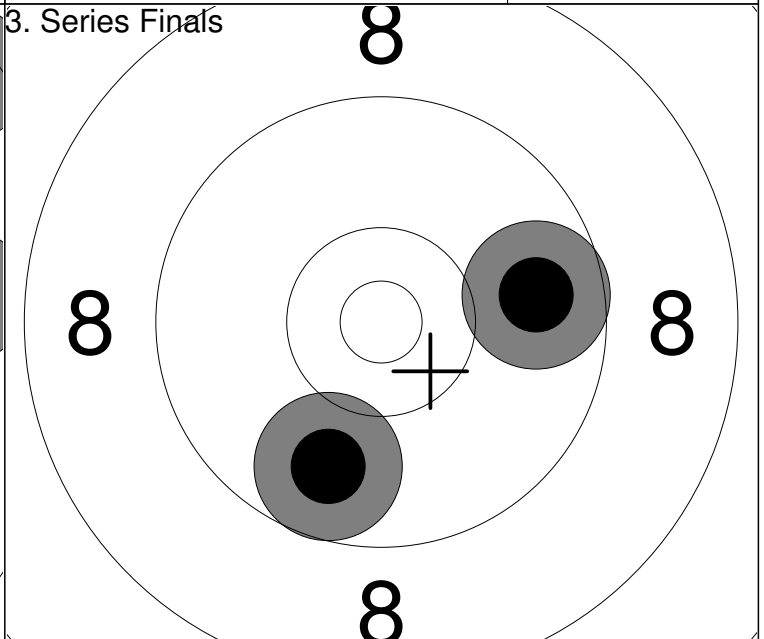
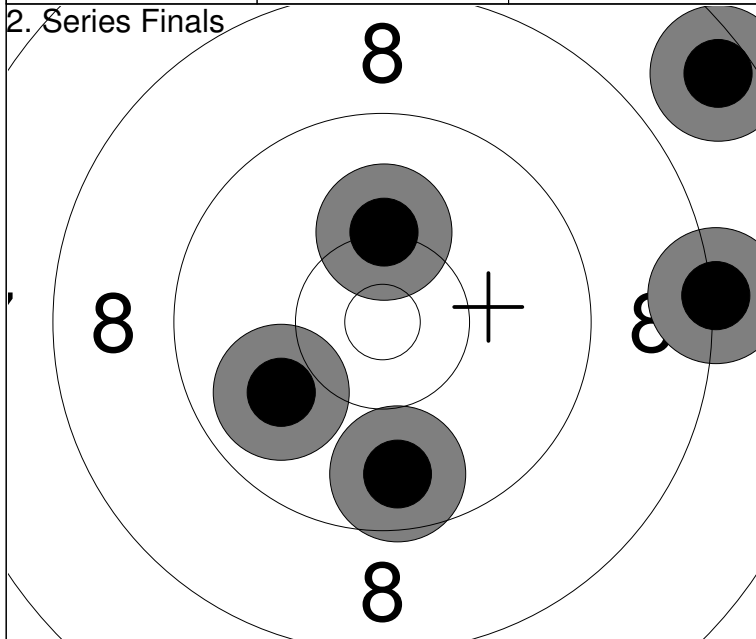

1: 10.2 ↑	Series	45.5
2: 9.7 ↓		
3: 8.2 →	Series	89.2
4: 7.5 ↗		
5: 9.9 ↙		

1: 9.8 →	Series	19.6
2: 9.8 ↓		
	Series	108.8

Relay **1** Lane **9** **FU Daniel yuhui**

2023 AHA Memorial BC F MP

18.11.2023 Event name 65 Alberta Handgun Association

Comment Signature

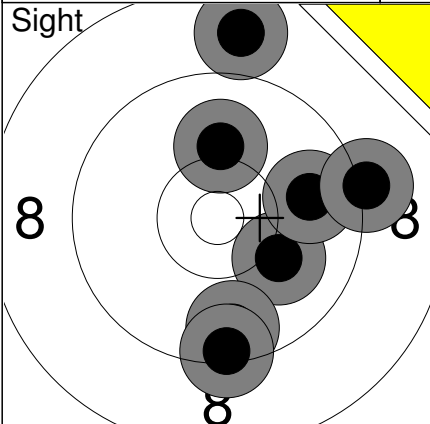
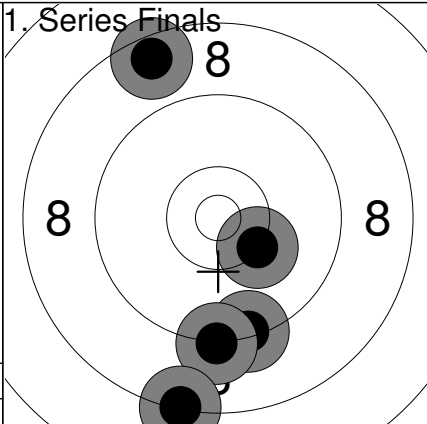
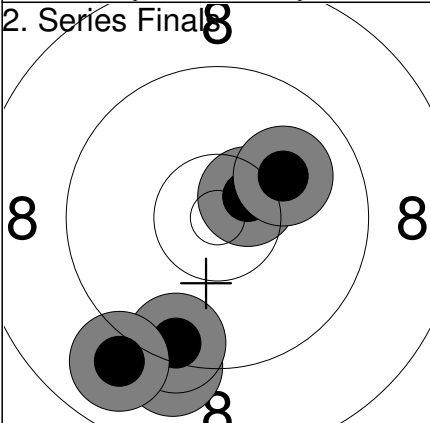
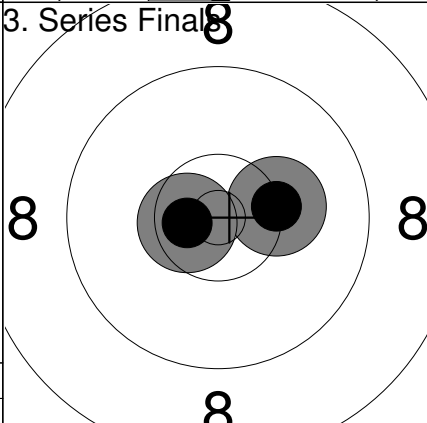
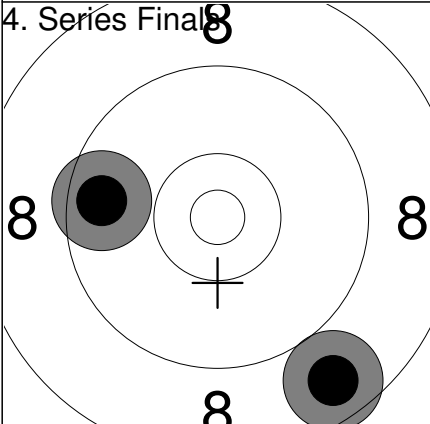
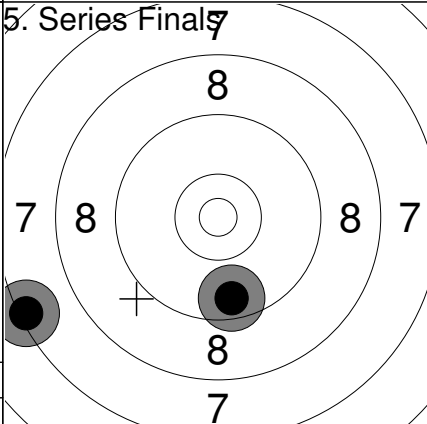
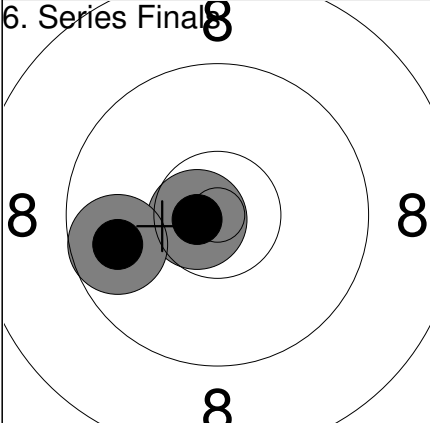
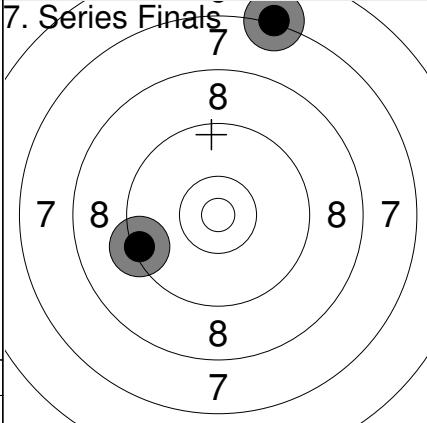
<p>Sight</p> 	<p>1: 10.1 → 2: 9.6 ↓ 3: 10.1 ↑ 4: 8.7 ↑ 5: 9.8 → 6: 9.4 ↓ 7: 9.1 →</p> <p>Series 66.8 0.0</p>	<p>1. Series Finals</p>  <p>1: 9.3 ↓ 2: 10.3 → 3: 9.2 ↓ 4: 8.5 ↑ 5: 8.3 ↓</p> <p>Series 45.6 45.6</p>	
<p>2. Series Finals</p> 	<p>1: 9.2 ↓ 2: 10.5x → 3: 10.1 → 4: 9.4 ↓ 5: 9.0 ↓</p> <p>Series 48.2 93.8</p>	<p>3. Series Finals</p>  <p>1: 10.3 → 2: 10.6x ←</p> <p>Series 20.9 114.7</p>	
<p>4. Series Finals</p> 	<p>1: 8.7 ↓ 2: 9.6 ←</p> <p>Series 18.3 133.0</p>	<p>5. Series Finals</p>  <p>1: 7.3 ← 2: 9.6 ↓</p> <p>Series 16.9 149.9</p>	
<p>6. Series Finals</p> 	<p>1: 10.7x ← 2: 9.8 ←</p> <p>Series 20.5 170.4</p>	<p>7. Series Finals</p>  <p>1: 7.2 ↑ 2: 9.4 ←</p> <p>Series 16.6 187.0</p>	

Relay 1	Lane 10	WICK Werner	
-------------------	-------------------	--------------------	--

2023 AHA Memorial	AB	F	MP
-------------------	----	---	----

18.11.2023	Event name 65	Alberta Handgun Association
------------	---------------	-----------------------------

Comment	Signature
---------	-----------

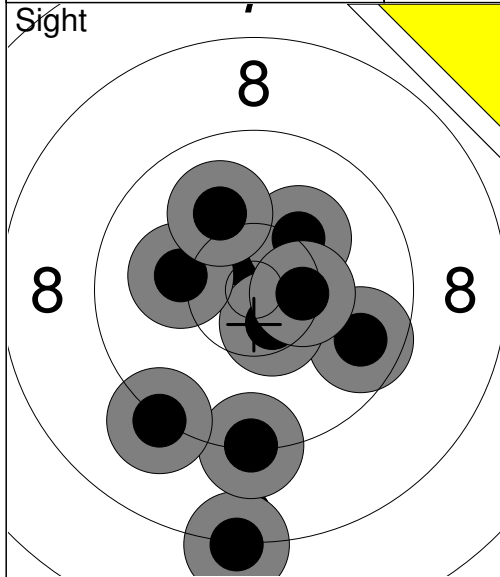

1:	8.2	↓
2:	10.6x	↖
3:	9.7	→
4:	10.5x	↓
5:	10.2	↗
6:	10.4x	→
7:	9.3	↓
8:	10.1	←
9:	9.2	↙
10:	10.1	↖
Series	98.3	
	0.0	

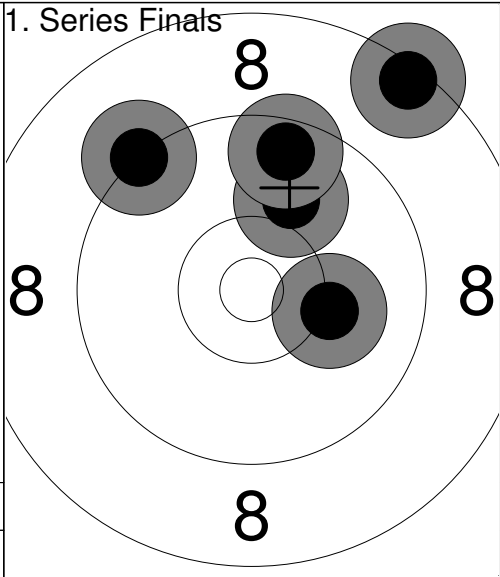

1:	10.2	→
2:	10.0	↗
3:	8.4	↗
4:	9.2	↖
5:	9.5	↗
Series	47.3	
	47.3	

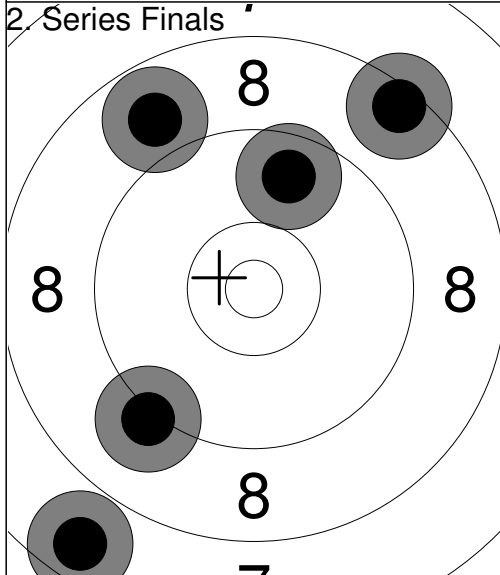

1:	9.1	↙
2:	8.4	↗
3:	8.8	↖
4:	7.6	↙
5:	9.7	↗
Series	43.6	
	90.9	

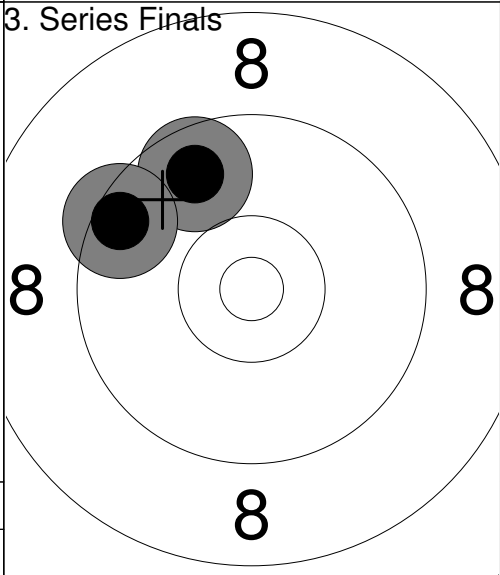

1:	9.7	↖
2:	9.5	↖
Series	19.2	
	110.1	

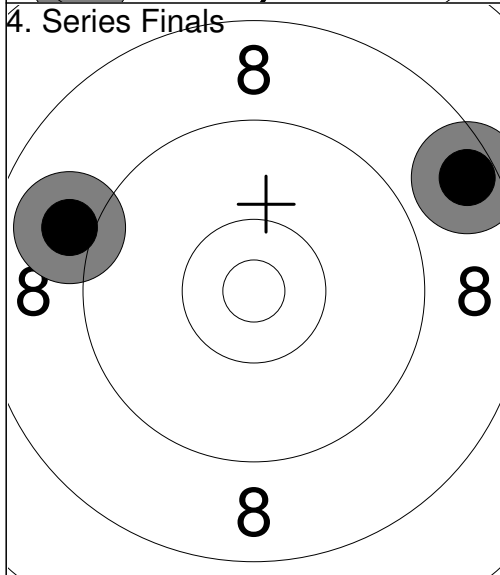

1:	8.5	↗
2:	9.0	←
Series	17.5	
	127.6	