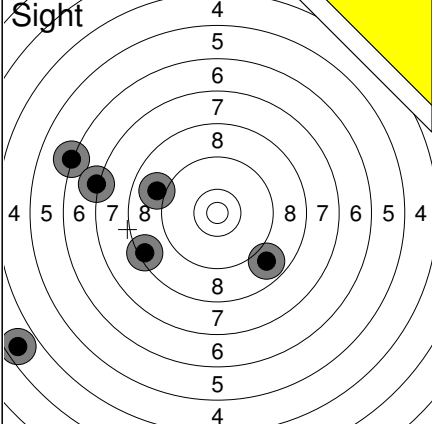
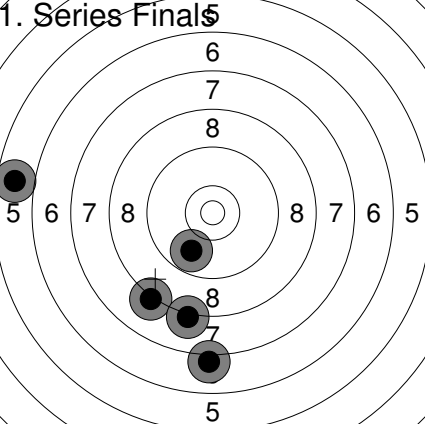
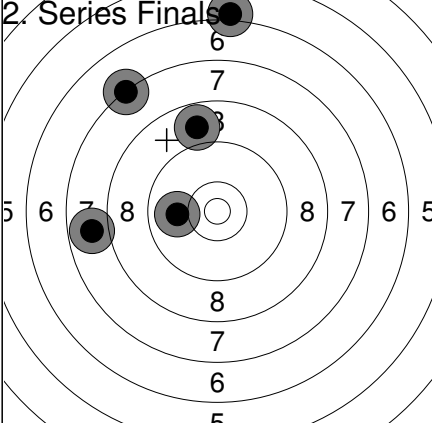
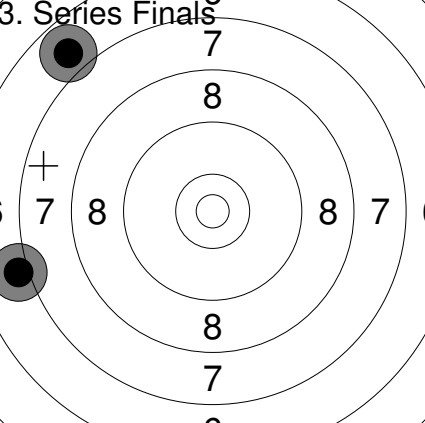
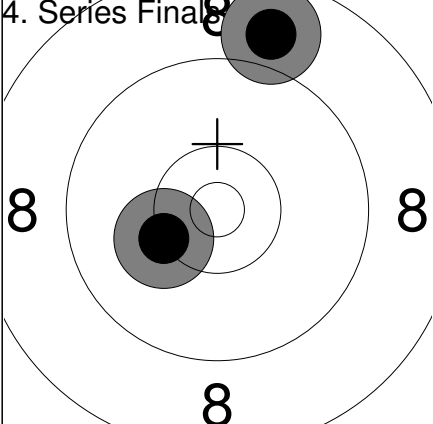
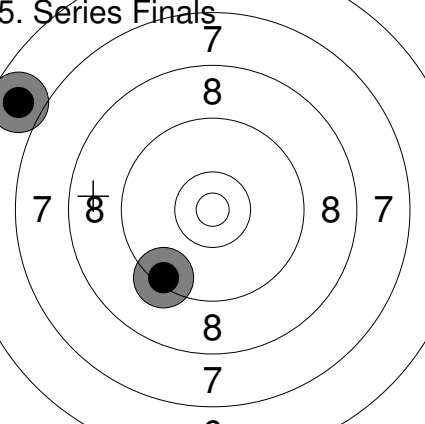
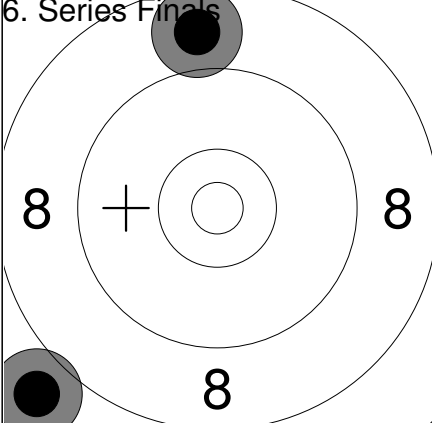

Relay 1	Lane 4	ZHENG Tingxi
-------------------	------------------	---------------------

2023 AHA Memorial	BC	F	WP
-------------------	----	---	----

18.11.2023	2023 Memorial Finals AP60W	Alberta Handgun Association
------------	----------------------------	-----------------------------

Comment	Signature
---------	-----------

<p>Sight</p> 	<p>1: 6.2 ←</p> <p>2: 8.4 ←</p> <p>3: 3.6 ←</p> <p>4: 9.0 ←</p> <p>5: 8.8 ↘</p> <p>6: 7.2 ←</p>	<p>1. Series Finals</p> 	<p>1: 8.2 ↘</p> <p>2: 8.1 ↓</p> <p>3: 9.8 ↘</p> <p>4: 5.7 ←</p> <p>5: 7.1 ↓</p>
	<p>Series 43.2</p> <p>0.0</p>		<p>Series 38.9</p> <p>38.9</p>
<p>2. Series Finals</p> 	<p>1: 7.3 ↗</p> <p>2: 10.0 ←</p> <p>3: 8.8 ↑</p> <p>4: 7.8 ←</p> <p>5: 6.1 ↑</p>	<p>3. Series Finals</p> 	<p>1: 6.8 ↗</p> <p>2: 7.0 ←</p>
	<p>Series 40.0</p> <p>78.9</p>		<p>Series 13.8</p> <p>92.7</p>
<p>4. Series Finals</p> 	<p>1: 10.3 ←</p> <p>2: 8.9 ↑</p>	<p>5. Series Finals</p> 	<p>1: 9.4 ↘</p> <p>2: 6.8 ↗</p>
	<p>Series 19.2</p> <p>111.9</p>		<p>Series 16.2</p> <p>128.1</p>
<p>6. Series Finals</p> 	<p>1: 8.8 ↑</p> <p>2: 7.8 ↘</p>		
	<p>Series 16.6</p> <p>144.7</p>		

Relay 1	Lane 5	NICOL Sophia ting	
-------------------	------------------	--------------------------	--

2023 AHA Memorial	BC	F	WP
-------------------	----	---	----

18.11.2023	2023 Memorial Finals AP60W	Alberta Handgun Association	
------------	----------------------------	-----------------------------	--

Comment	Signature		
---------	-----------	--	--

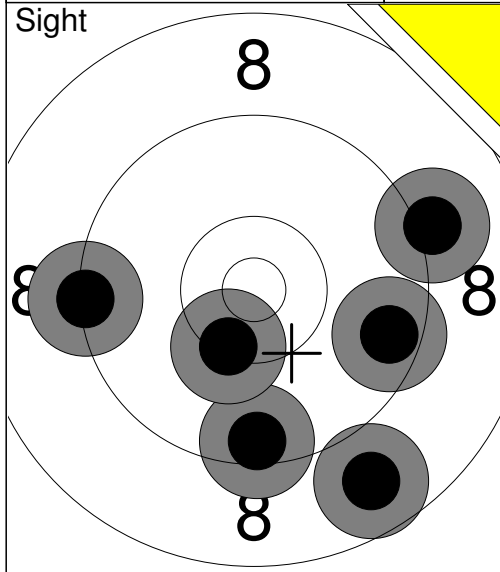

1:	8.7	↘
2:	9.5	→
3:	9.5	↓
4:	9.3	←
5:	10.3	↙
6:	9.1	→
Series	56.4	
	0.0	

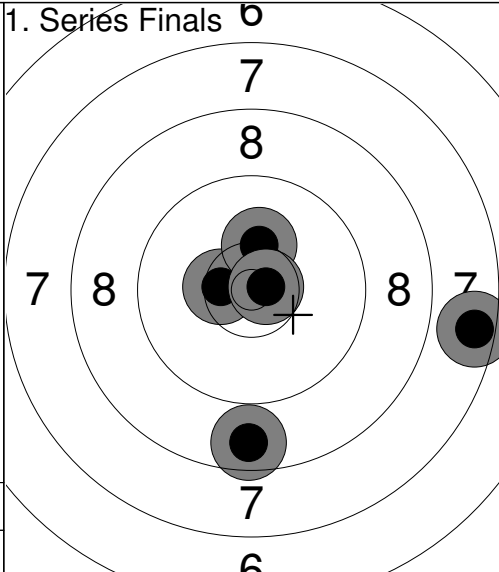

1:	10.5x	←
2:	7.5	→
3:	8.7	↓
4:	10.3	↑
5:	10.7x	→
Series	47.7	
	47.7	

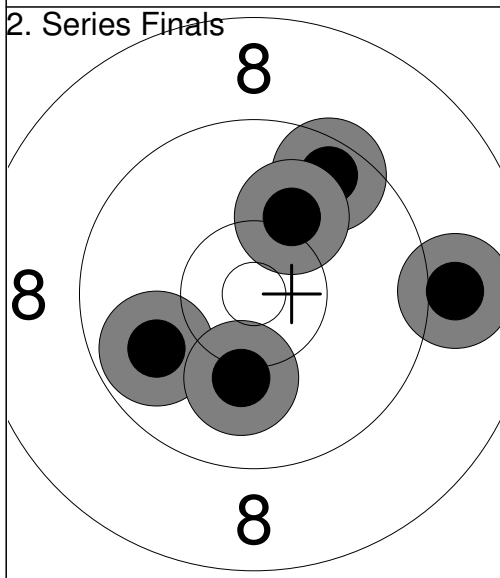

1:	9.0	→
2:	9.6	↗
3:	9.9	←
4:	10.1	↗
5:	10.1	↓
Series	48.7	
	96.4	

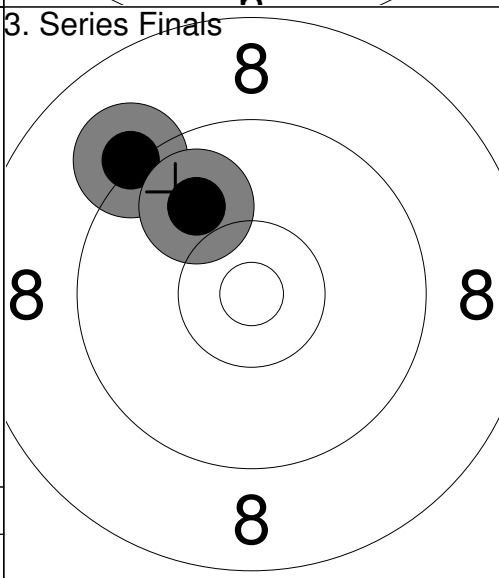

1:	9.2	↖
2:	9.9	↖
Series	19.1	
	115.5	

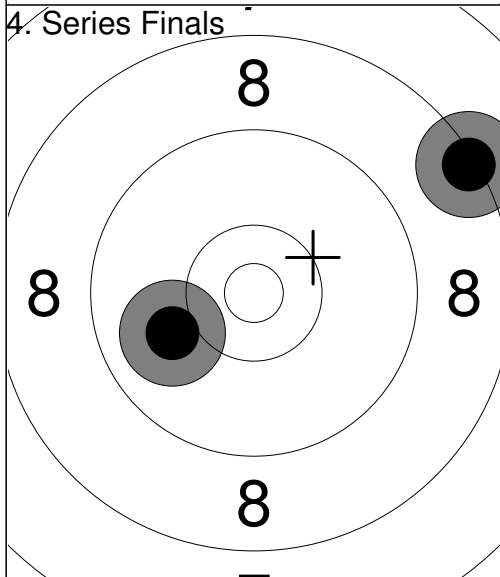

1:	8.3	↗
2:	10.0	←
Series	18.3	
	133.8	

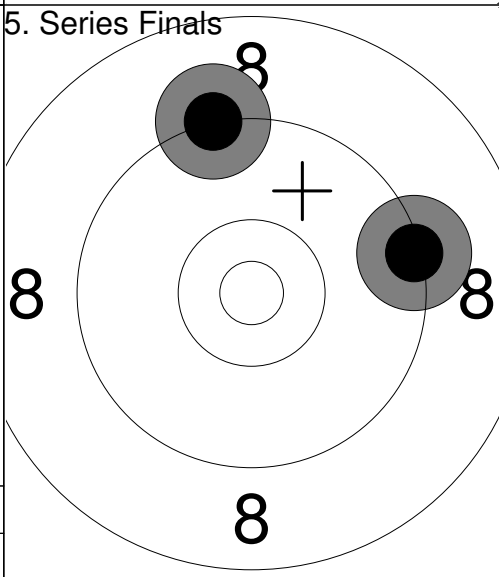

1:	9.3	→
2:	9.2	↑
Series	18.5	
	152.3	

6. Series Finals /

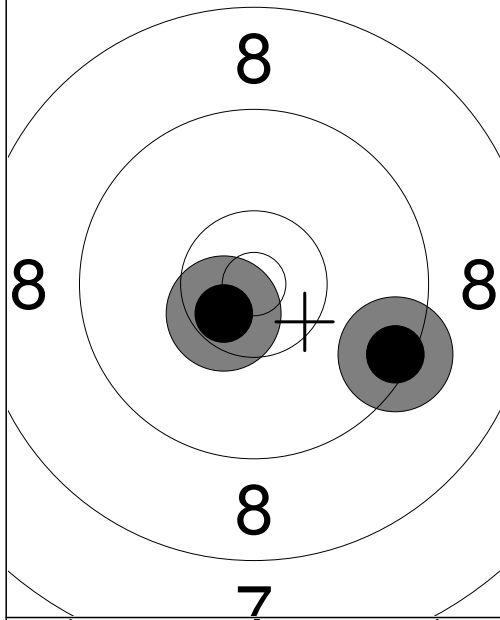

1: 10.5x ↙

2: 9.4 ➤

Series 19.9

172.2

7. Series Finals /

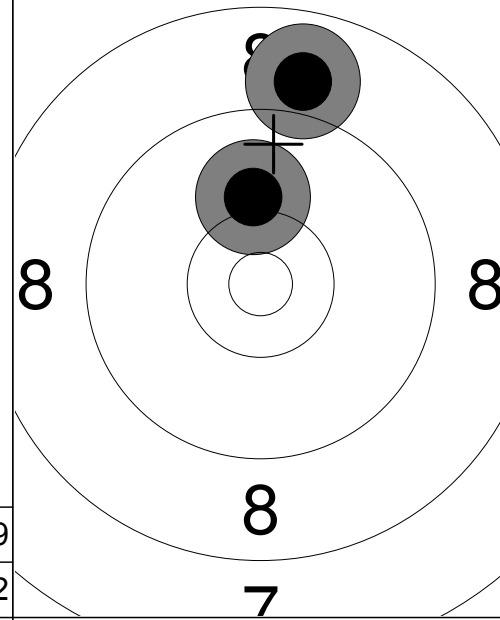

1: 10.1 ↑

2: 8.9 ↗

Series 19.0

191.2

8. Series Finals /

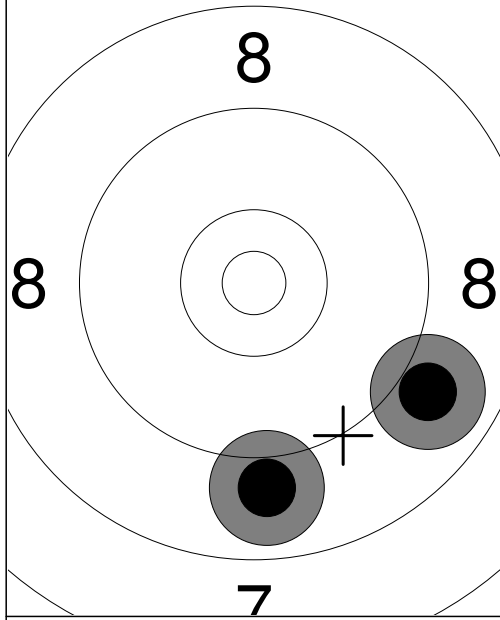

1: 8.9 ➤

2: 8.9 ↓

Series 17.8

209.0

Relay 1	Lane 6	KIEJKO Lynda
-------------------	------------------	---------------------

2023 AHA Memorial	AB	F	WP
-------------------	----	---	----

18.11.2023	2023 Memorial Finals AP60W	Alberta Handgun Association
------------	----------------------------	-----------------------------

Comment	Signature
---------	-----------

<p>Sight</p>	<p>1: 10.0 ↙</p> <p>2: 9.5 ↑</p> <p>3: 10.2 ←</p> <p>4: 9.1 ↓</p> <p>5: 10.0 →</p> <p>6: 9.9 ↓</p> <p>7: 10.3 ↓</p>	<p>1. Series Finals</p>	<p>1: 7.9 ↑</p> <p>2: 7.7 ←</p> <p>3: 10.6x ↓</p> <p>4: 10.6x ↙</p> <p>5: 9.2 ↖</p>
	<p>Series 69.0</p> <p>0.0</p>		<p>Series 46.0</p> <p>46.0</p>

<p>2. Series Finals</p>	<p>1: 9.8 ↖</p> <p>2: 9.4 ↘</p> <p>3: 9.9 ↙</p> <p>4: 8.9 ↘</p> <p>5: 9.1 ↓</p>	<p>3. Series Finals</p>	<p>1: 8.9 ←</p> <p>2: 9.7 ↙</p>
	<p>Series 47.1</p> <p>93.1</p>		<p>Series 18.6</p> <p>111.7</p>

<p>4. Series Finals</p>	<p>1: 10.4x ←</p> <p>2: 10.3 ←</p>	<p>5. Series Finals</p>	<p>1: 9.5 ←</p> <p>2: 9.9 ↙</p>
	<p>Series 20.7</p> <p>132.4</p>		<p>Series 19.4</p> <p>151.8</p>

6. Series Finals /

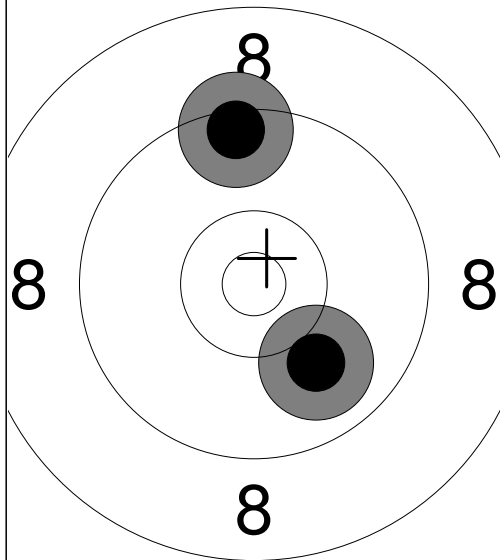

1: 9.4 ↑
2: 10.0 ↓

Series 19.4
171.2

7. Series Finals /

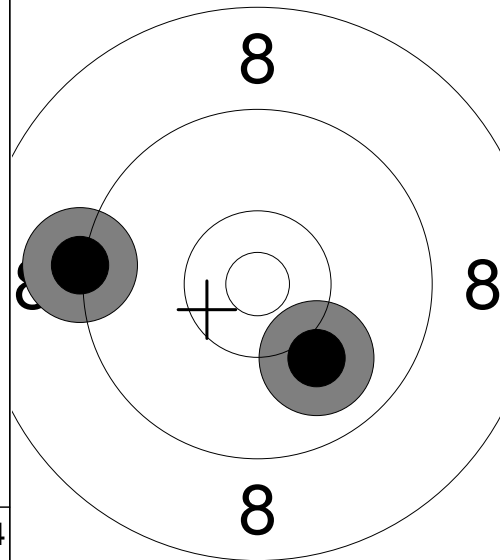

1: 9.2 ←
2: 10.0 ↓

Series 19.2
190.4

8. Series Finals /

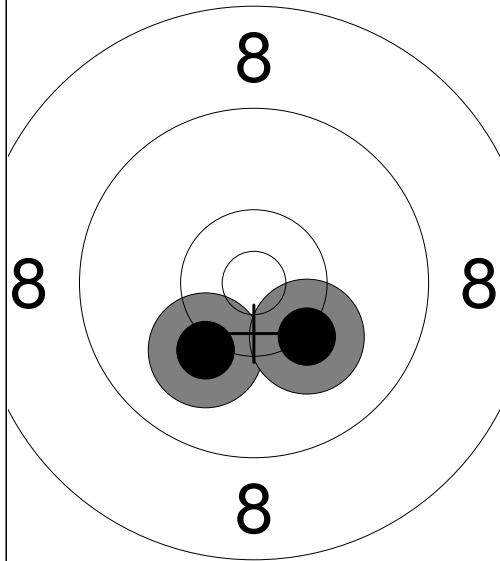

1: 10.1 ↓
2: 10.2 ↓

Series 20.3
210.7

9. Series Finals /

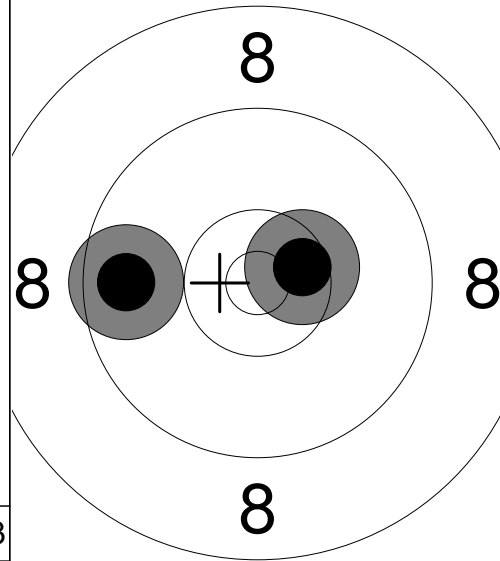

1: 10.5x →
2: 9.7 ←

Series 20.2
230.9

Relay 1	Lane 7	BRITTON Kim
-------------------	------------------	--------------------

2023 AHA Memorial	AB	F	WP
-------------------	----	---	----

18.11.2023	2023 Memorial Finals AP60W	Alberta Handgun Association
------------	----------------------------	-----------------------------

Comment	Signature
---------	-----------

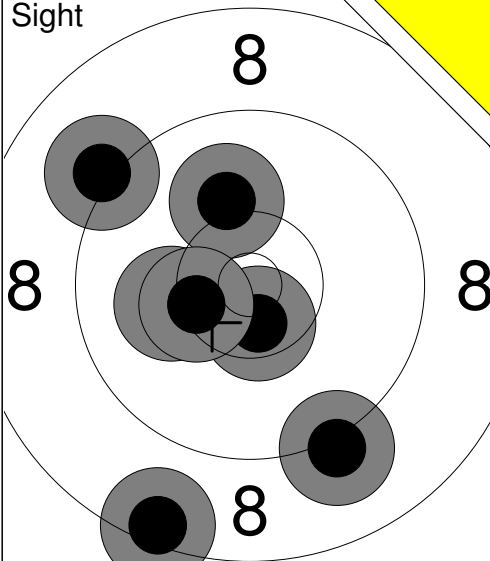
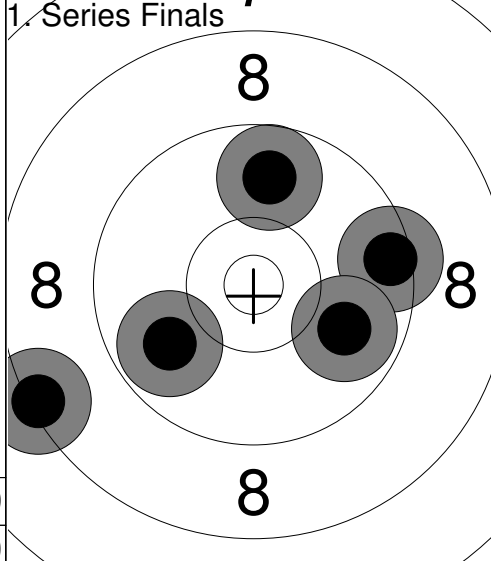
<p>Sight</p> 	<p>1. Series Finals</p> 	<p>1: 9.1 ↖ 2: 8.4 ↓ 3: 9.1 ↓ 4: 10.6x ↓ 5: 10.2 ← 6: 10.1 ↑ 7: 10.4x ←</p> <p>1: 8.3 ↙ 2: 9.8 ↑ 3: 9.5 → 4: 9.9 ↙ 5: 9.9 →</p>
Series 67.9	Series 47.4	
0.0	47.4	

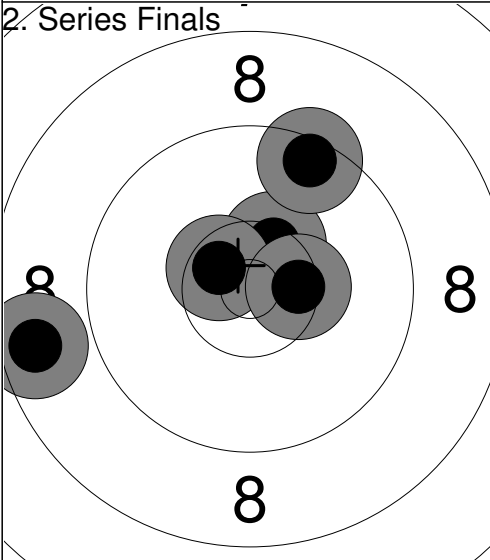
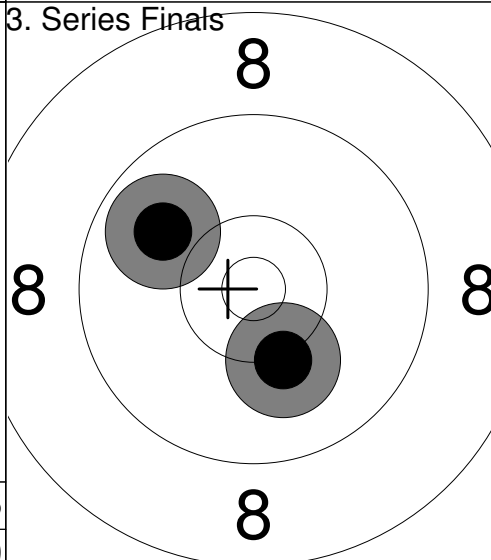
<p>2. Series Finals</p> 	<p>3. Series Finals</p> 	<p>1: 10.4x ↗ 2: 8.6 ← 3: 9.5 ↑ 4: 10.6x ↖ 5: 10.4x →</p> <p>1: 10.2 ↓ 2: 9.9 ↖</p>
Series 49.5	Series 20.1	
96.9	117.0	

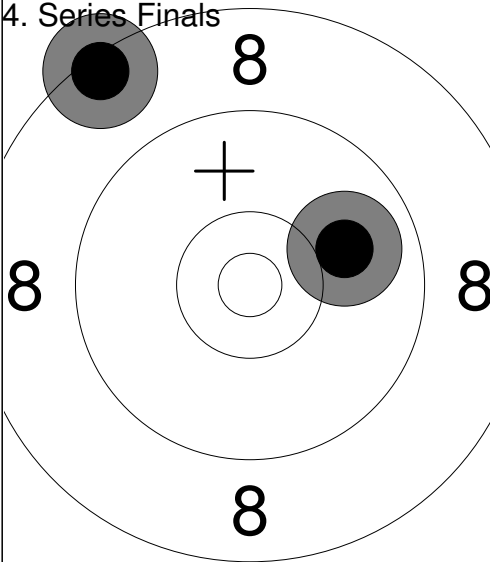
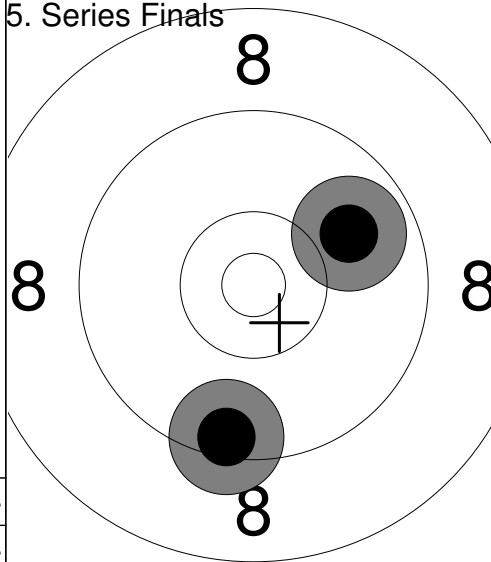
<p>4. Series Finals</p> 	<p>5. Series Finals</p> 	<p>1: 10.0 → 2: 8.4 ↖</p> <p>1: 9.9 ↗ 2: 9.4 ↓</p>
Series 18.4	Series 19.3	
135.4	154.7	

6. Series Finals

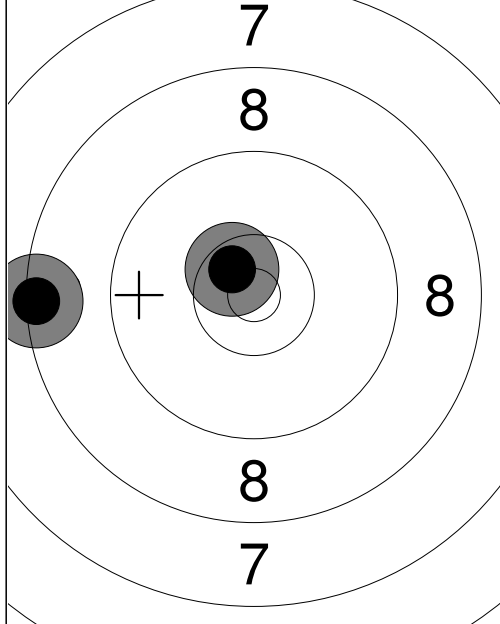

1:	8.3	←
2:	10.6x	↖
Series	18.9	
	173.6	

7. Series Finals /

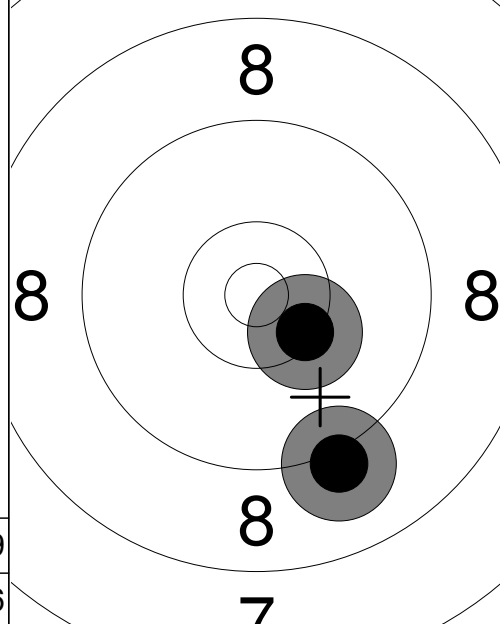

1:	9.1	↘
2:	10.3	↘
Series	19.4	
	193.0	

8. Series Finals /

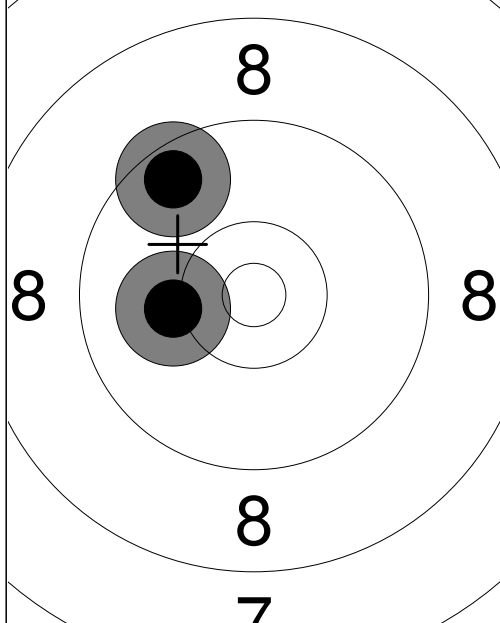

1:	10.1	←
2:	9.6	↖
Series	19.7	
	212.7	

9. Series Finals /

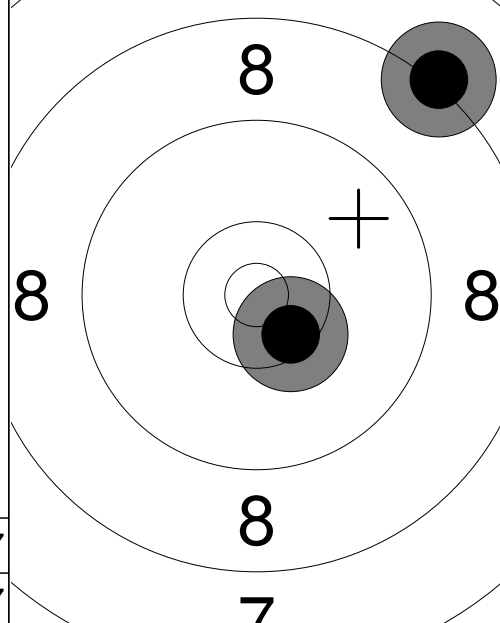

1:	8.2	↗
2:	10.4x	↘
Series	18.6	
	231.3	

Relay **1** Lane **8** **NELSON Makayla**

2023 AHA Memorial SK F WP

18.11.2023 2023 Memorial Finals AP60W Alberta Handgun Association

Comment Signature

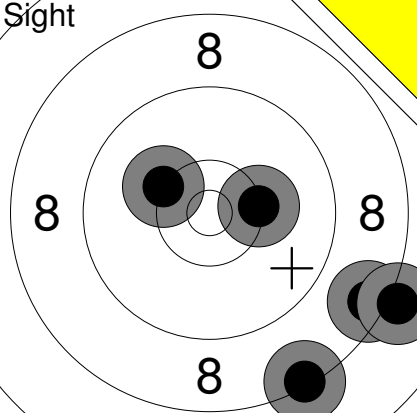
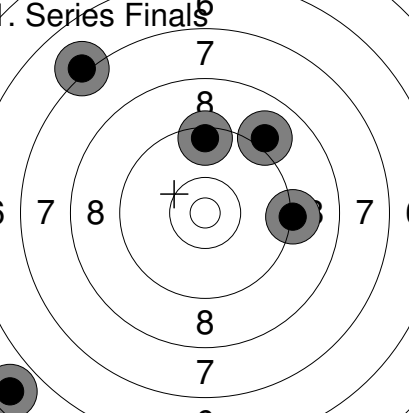
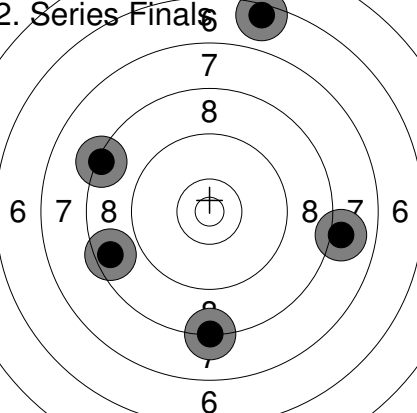
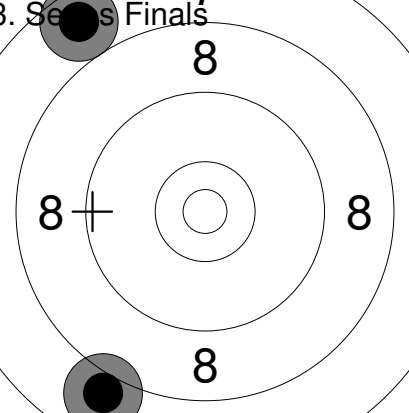
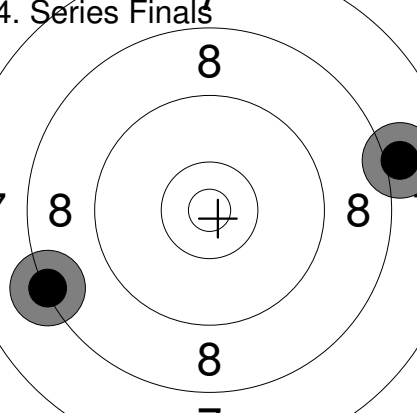
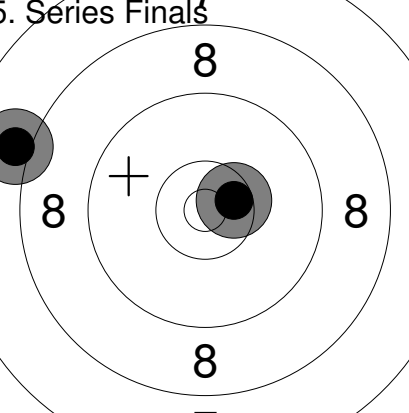
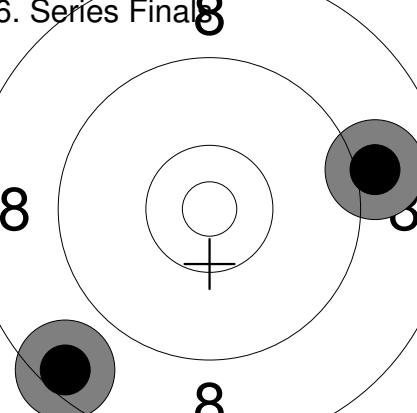
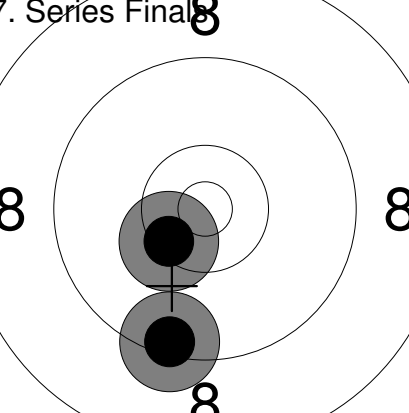
<p>Sight</p> 	<p>1: 10.3 → 2: 10.2 ↗ 3: 8.5 ↘ 4: 8.3 ↘ 5: 8.1 ↓</p> <p>Series 45.4 0.0</p>	<p>1. Series Finals</p> 	<p>1: 7.1 ↖ 2: 5.6 ↙ 3: 9.0 ↗ 4: 9.2 → 5: 9.4 ↑</p> <p>Series 40.3 40.3</p>
<p>2. Series Finals</p> 	<p>1: 6.5 ↑ 2: 8.3 ↓ 3: 8.6 ← 4: 8.0 → 5: 8.3 ↖</p> <p>Series 39.7 80.0</p>	<p>3. Series Finals</p> 	<p>1: 7.7 ↖ 2: 8.0 ↙</p> <p>Series 15.7 95.7</p>
<p>4. Series Finals</p> 	<p>1: 8.3 ← 2: 8.0 →</p> <p>Series 16.3 112.0</p>	<p>5. Series Finals</p> 	<p>1: 8.0 ← 2: 10.5x →</p> <p>Series 18.5 130.5</p>
<p>6. Series Finals</p> 	<p>1: 8.5 ↙ 2: 9.0 →</p> <p>Series 17.5 148.0</p>	<p>7. Series Finals</p> 	<p>1: 9.4 ↓ 2: 10.4x ↙</p> <p>Series 19.8 167.8</p>