

Relay **1** Lane **2** **ROBBERSTAD Steven**

2023 AHA Memorial AB SP MP

18.11.2023 2023 Memorial Q Alberta Handgun Association

Comment Signature

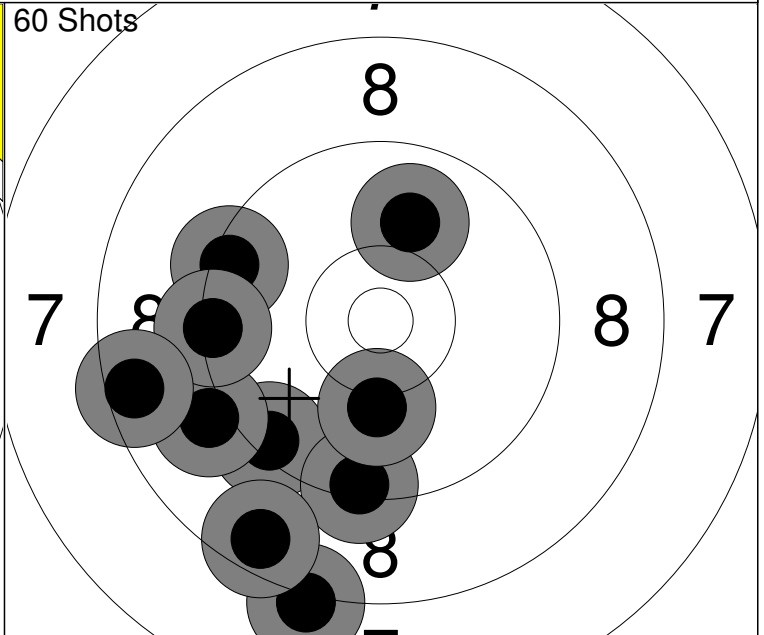
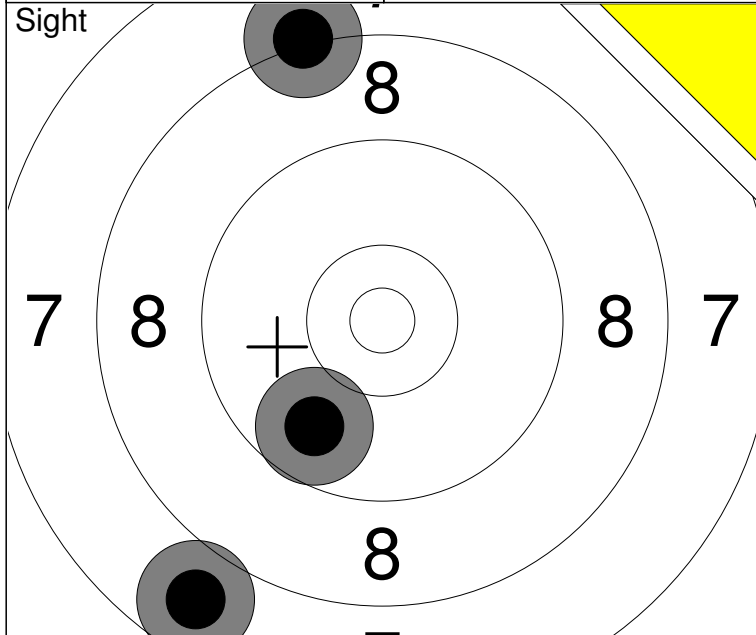

1:	7.8	↘
2:	8.2	↑
3:	9.8	↘

Series	24 (0x)
	0 (0x)

1:	10.0	↑
2:	9.4	↘
3:	9.4	↙
4:	9.1	↙
5:	9.4	↓

6:	10.1	↓
7:	8.2	↓
8:	8.6	↓
9:	9.3	←
10:	8.5	←

Series	89 (0x)
	89 (0x)

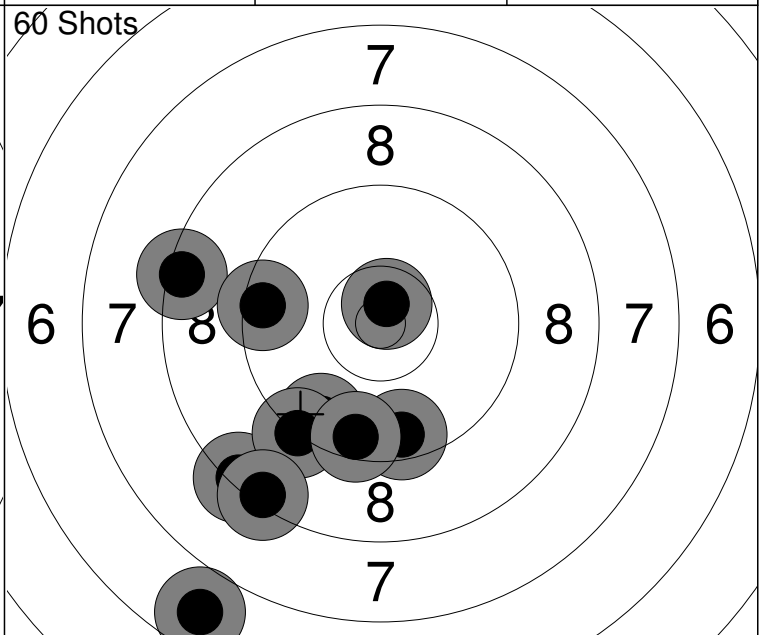
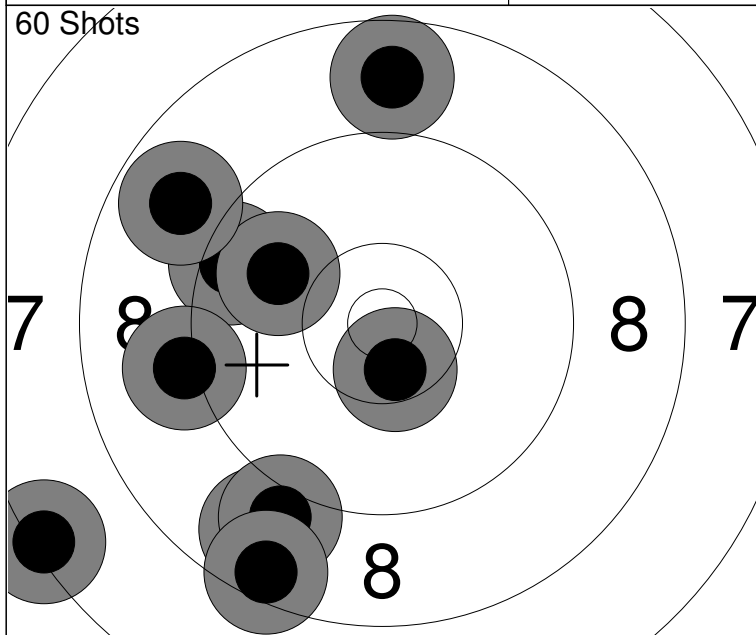

11:	9.5	↙
12:	9.9	↙
13:	8.8	↘
14:	9.0	↘
15:	10.5x	↓

16:	8.8	↙
17:	8.7	↑
18:	8.5	↘
19:	9.1	←
20:	7.3	↙

Series	85 (1x)
	174 (1x)

21:	6.7	↘
22:	8.4	←
23:	9.5	↓
24:	9.6	↘
25:	10.7x	↑

26:	8.3	↘
27:	9.2	↘
28:	9.5	←
29:	8.4	↘
30:	9.5	↓

Series	85 (1x)
	259 (2x)

Relay **1** Lane **3** **HAGLUND Wayne**

2023 AHA Memorial AB SP MP

18.11.2023 2023 Memorial Q Alberta Handgun Association

Comment Signature

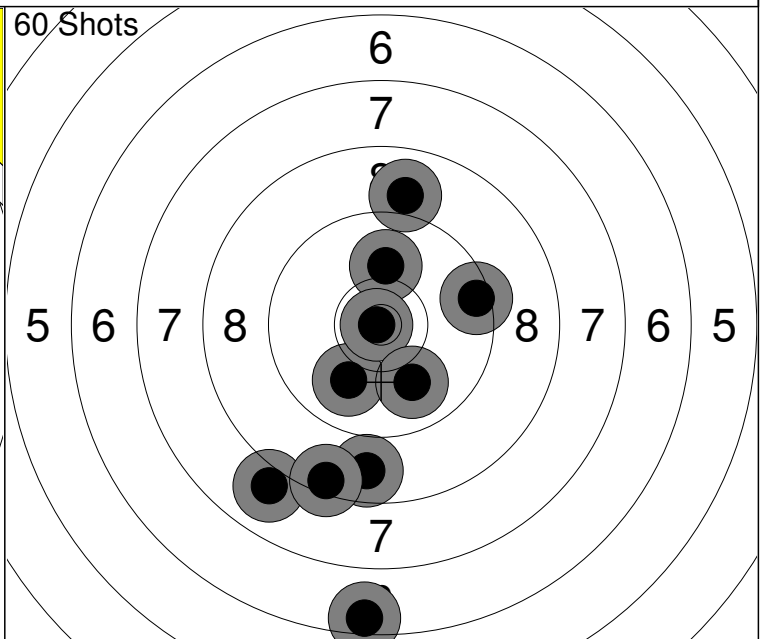
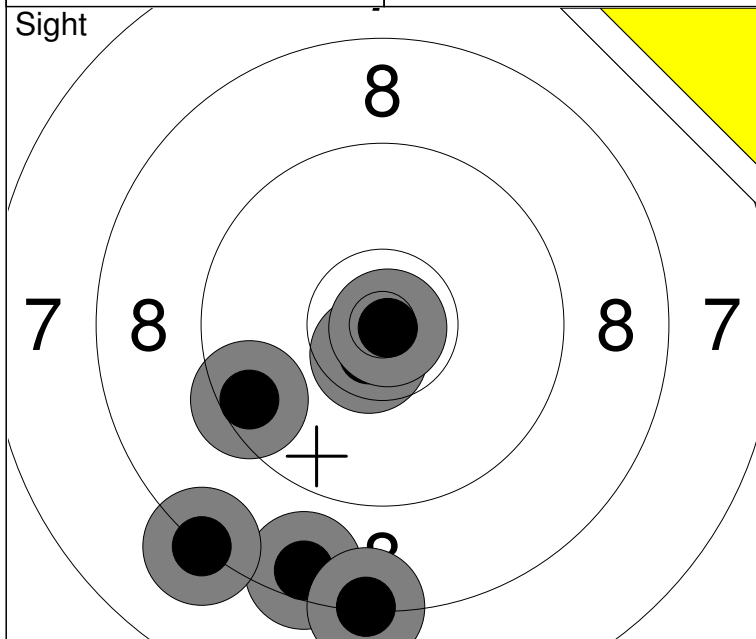

1: 10.6x ↓	6: 9.5 ←	Series 53 (2x)
2: 8.5 ↓		
3: 8.3 ↓		0 (0x)
4: 10.9x →		
5: 8.2 ↙		

1: 10.0 ↑	6: 8.9 ↑	Series 87 (1x)
2: 8.0 ↙	7: 6.5 ↓	
3: 10.0 ↓	8: 8.4 ↓	87 (1x)
4: 8.7 ↓	9: 10.0 ↓	
5: 10.9x ←	10: 9.4 →	

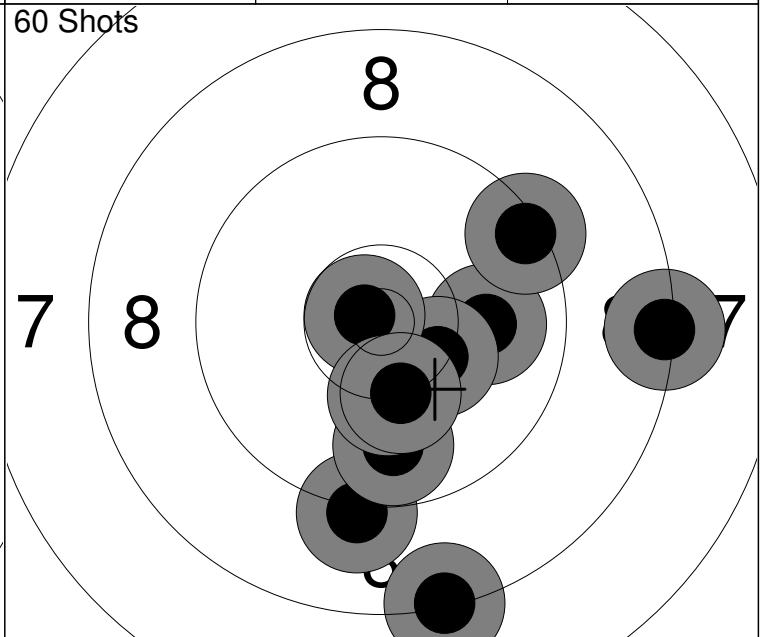
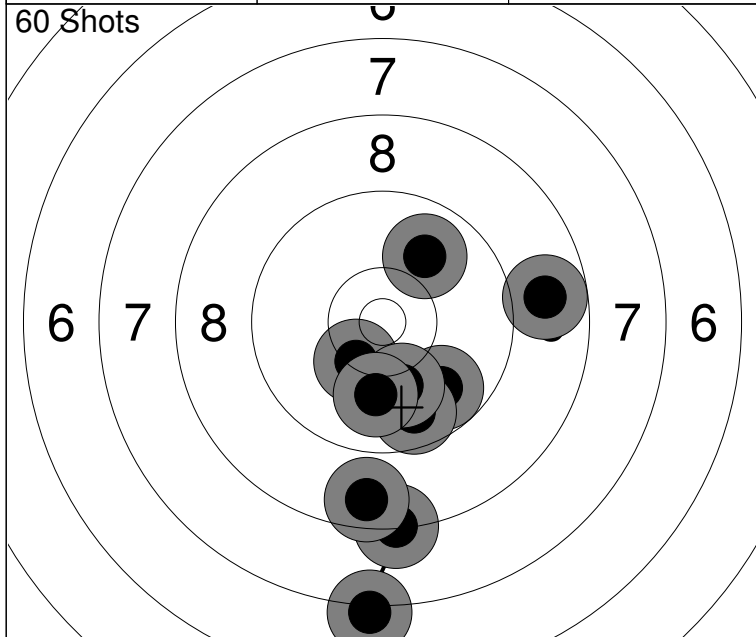

11: 9.8 ↓	16: 10.1 ↓	Series 88 (0x)
12: 10.3 ↙	17: 8.8 →	
13: 7.1 ↓	18: 9.9 ↗	175 (1x)
14: 8.3 ↓	19: 10.0 ↓	
15: 9.7 ↓	20: 8.6 ↓	

21: 9.2 ↓	26: 10.8x ←	Series 93 (1x)
22: 8.3 →	27: 10.3 ↓	
23: 10.0 →	28: 9.4 ↗	268 (2x)
24: 9.8 ↓	29: 10.3 ↓	
25: 10.3 ↙	30: 8.3 ↓	

Relay 1	Lane 4	<h1>TURNER Byron</h1>
-------------------	------------------	-----------------------

2023 AHA Memorial	AB	SP	MP
-------------------	----	----	----

18.11.2023	2023 Memorial Q	Alberta Handgun Association
------------	-----------------	-----------------------------

Comment	Signature
---------	-----------

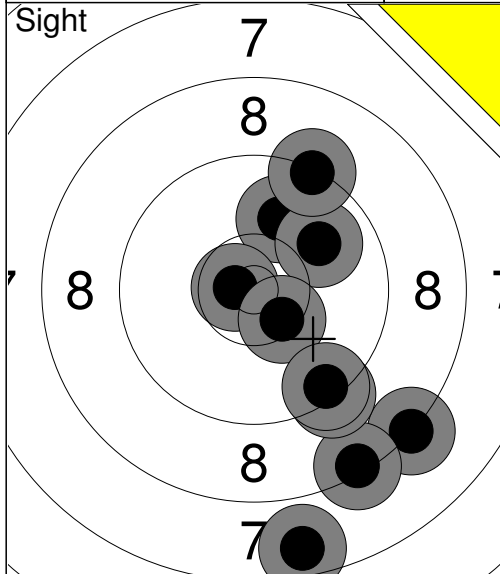

1:	10.0	↑
2:	8.3	↓
3:	7.6	↓
4:	10.7x	←
5:	9.9	↗
6:	10.4x	↓
7:	8.3	↓
8:	9.3	↓
9:	9.3	↑
10:	9.4	↓
Series		89 (2x)
		0 (0x)

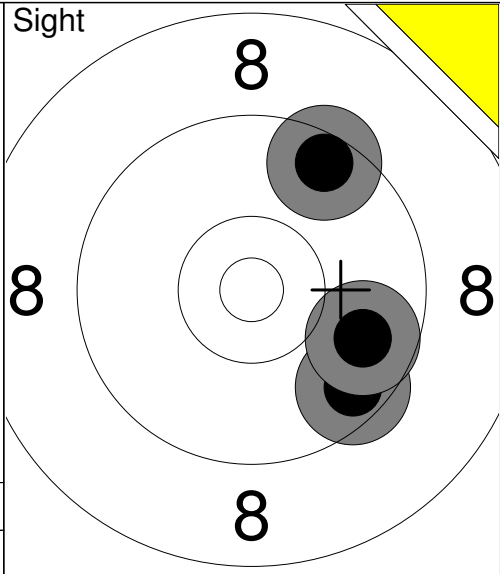

11:	9.6	↓
12:	9.8	↗
13:	9.5	↗
Series		27 (0x)
		0 (0x)

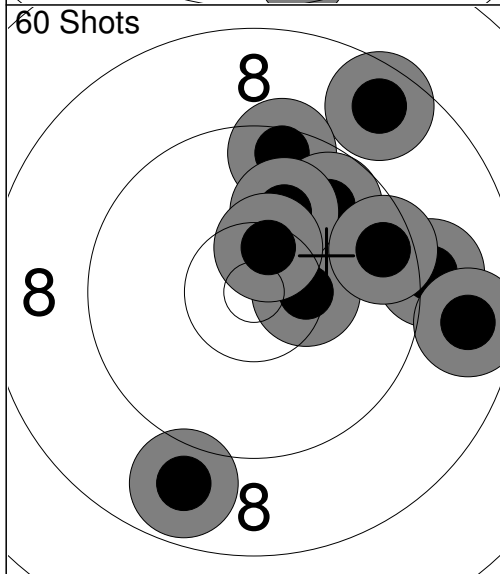

1:	8.6	↗
2:	9.5	↑
3:	8.8	↓
4:	9.8	↗
5:	10.4x	→
6:	10.1	↑
7:	10.5x	↑
8:	9.1	→
9:	8.7	→
10:	9.5	→
Series		90 (2x)
		90 (2x)

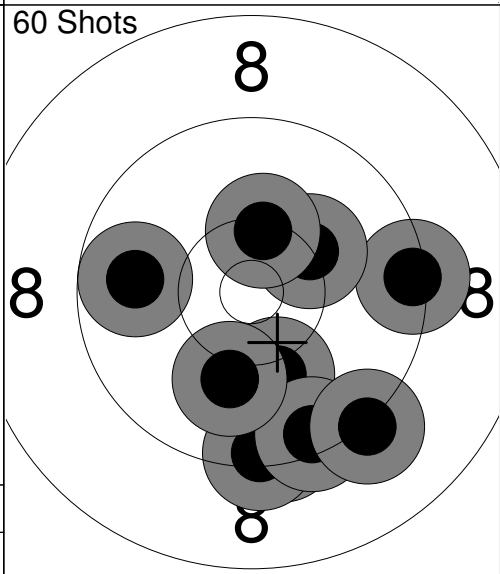

11:	9.4	→
12:	9.4	↓
13:	10.1	↓
14:	10.3	↗
15:	10.3	↑
16:	9.8	←
17:	9.4	↓
18:	9.4	↓
19:	9.2	↓
20:	10.1	↓
Series		94 (0x)
		184 (2x)

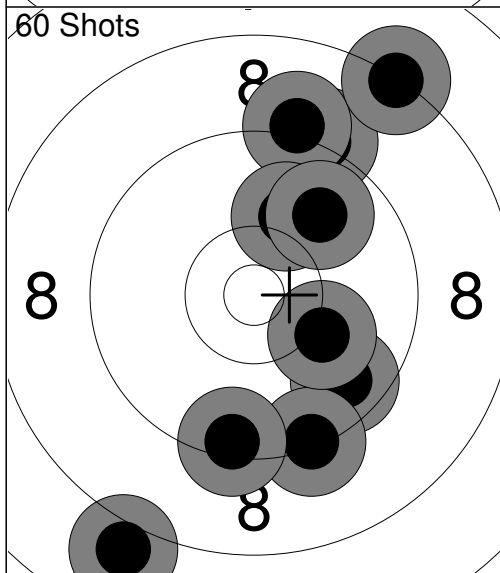

21:	9.2	↑
22:	9.6	↓
23:	8.0	↓
24:	9.3	↓
25:	10.1	↓
26:	9.1	↑
27:	9.4	↓
28:	8.3	↗
29:	10.1	↑
30:	9.9	↗
Series		90 (0x)
		274 (2x)

Relay **1** Lane **6** **IKEDA Tye e.**

2023 AHA Memorial AB SR MP

18.11.2023 2023 Memorial Q Alberta Handgun Association

Comment Signature

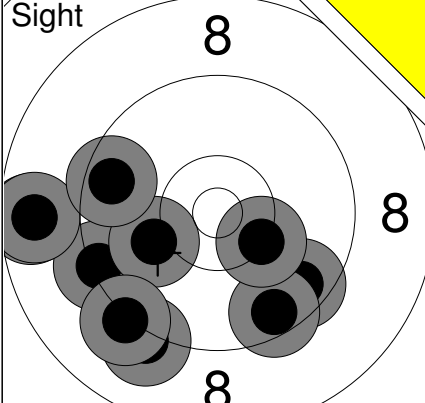
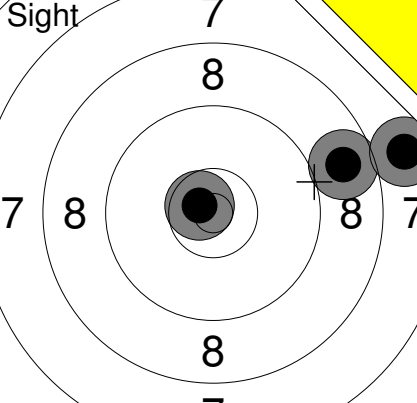
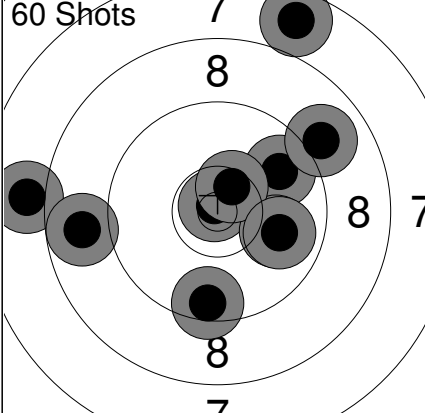
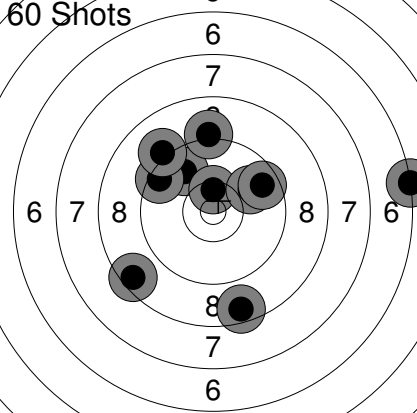
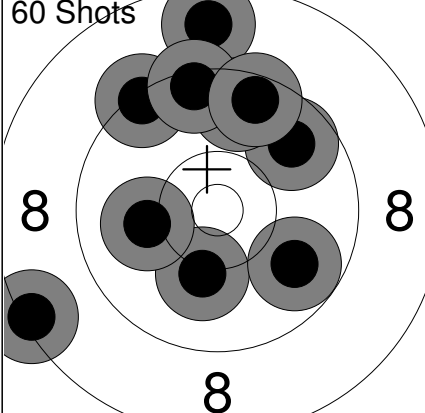
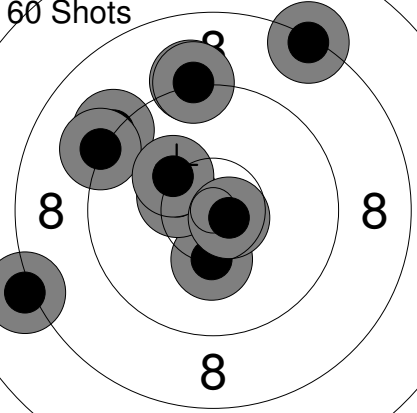
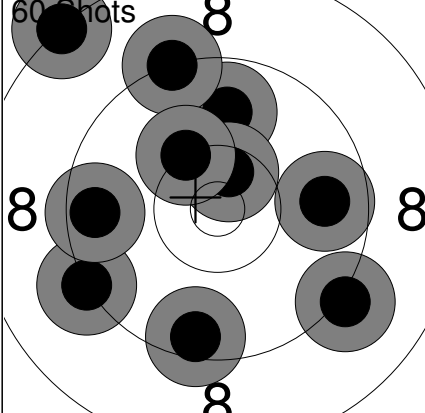
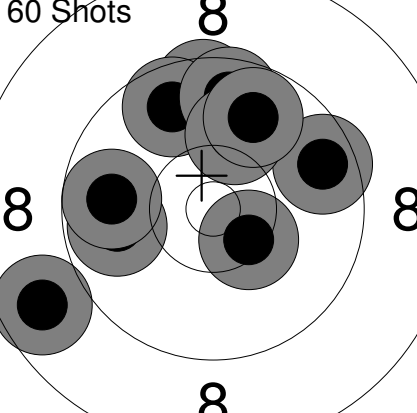
<p>Sight</p> 	<p>1: 9.6 ↘ 2: 8.6 ← 3: 9.1 ↘ 4: 9.5 ↘ 5: 9.3 ← 6: 10.3 ↘ 7: 8.7 ← 8: 10.1 ← 9: 9.2 ↘ 10: 9.6 ←</p> <p>Series 90 (0x) 0 (0x)</p>	<p>Sight</p> 	<p>11: 8.7 → 12: 7.7 → 13: 10.7x ↖</p> <p>Series 25 (1x) 0 (0x)</p>
<p>60 Shots</p> 	<p>1: 10.8x ↑ 2: 7.7 ↑ 3: 7.9 ← 4: 9.8 → 5: 10.0 → 6: 8.8 ← 7: 10.5x ↑ 8: 9.5 ↓ 9: 9.9 → 10: 9.0 ↗</p> <p>Series 88 (2x) 88 (2x)</p>	<p>60 Shots</p> 	<p>11: 9.8 ↖ 12: 10.4x ↑ 13: 6.2 → 14: 8.5 ↓ 15: 9.9 ↗ 16: 9.1 ↑ 17: 9.5 ↖ 18: 9.1 ↖ 19: 9.6 ↗ 20: 8.5 ↘</p> <p>Series 86 (1x) 174 (3x)</p>
<p>60 Shots</p> 	<p>21: 8.3 ← 22: 9.7 ↗ 23: 8.7 ↑ 24: 10.2 ↓ 25: 9.3 ↗ 26: 9.6 ↑ 27: 10.1 ← 28: 9.4 ↑ 29: 9.8 ↘ 30: 9.5 ↑</p> <p>Series 90 (0x) 264 (3x)</p>	<p>60 Shots</p> 	<p>31: 8.3 ↑ 32: 10.3 ↓ 33: 9.2 ↖ 34: 9.1 ↑ 35: 9.2 ↑ 36: 10.4x ↖ 37: 9.2 ↖ 38: 10.2 ↖ 39: 8.1 ← 40: 10.7x →</p> <p>Series 92 (2x) 356 (5x)</p>
<p>60 Shots</p> 	<p>41: 9.2 ← 42: 9.8 ↑ 43: 9.2 ↑ 44: 9.6 ← 45: 9.7 → 46: 8.2 ↗ 47: 10.5x ↑ 48: 9.2 ↘ 49: 10.2 ↗ 50: 9.5 ↓</p> <p>Series 91 (1x) 447 (6x)</p>	<p>60 Shots</p> 	<p>51: 10.4x ↘ 52: 9.6 → 53: 9.6 ↑ 54: 9.7 ↖ 55: 9.7 ↑ 56: 10.1 ↑ 57: 8.7 ↖ 58: 9.8 ↑ 59: 9.8 ← 60: 9.8 ←</p> <p>Series 91 (1x) 538 (7x)</p>

Relay **1** Lane **7** **LI Patrick**

2023 AHA Memorial AB JR MP

18.11.2023 2023 Memorial Q Alberta Handgun Association

Comment Signature

<p>Sight</p>	<p>1: 6.8 → 2: 6.3 ↑ 3: 6.5 ↗ 4: 3.1 ↑↑ 5: 8.4 ↑ 6: 6.9 ↗ 7: 5.5 ↑ 8: 9.5 ← 9: 9.3 ↙ 10: 5.3 ↙</p> <p>Series 63 (0x) 0 (0x)</p>	<p>Sight</p>	<p>11: 6.7 ↖</p> <p>Series 6 (0x) 0 (0x)</p>
<p>60 Shots</p>	<p>1: 5.9 ↖ 2: 8.9 ↑ 3: 7.4 ↑ 4: 6.0 ↓ 5: 9.6 ↖ 6: 8.4 ↗ 7: 8.9 → 8: 8.6 ↑ 9: 6.2 ↑ 10: 2.4 ↑</p> <p>Series 67 (0x) 67 (0x)</p>	<p>60 Shots</p>	<p>11: 7.0 ↑ 12: 6.7 ↑ 13: 10.2 ↑ 14: 6.6 ↑ 15: 9.6 ↑ 16: 6.5 ↑ 17: 7.6 ↖ 18: 8.7 ↑ 19: 7.0 ↗ 20: 8.3 ↑</p> <p>Series 74 (0x) 141 (0x)</p>
<p>60 Shots</p>	<p>21: 6.0 ↑ 22: 4.8 ↑ 23: 8.9 → 24: 5.7 ↑ 25: 6.6 ↑ 26: 8.7 ↗ 27: 3.5 ↑ 28: 3.4 ↑ 29: 7.8 ↑ 30: 8.6 ↑</p> <p>Series 58 (0x) 199 (0x)</p>	<p>60 Shots</p>	<p>31: 9.2 ↖ 32: 8.4 ↓ 33: 7.8 ↗ 34: 8.9 ↑ 35: 10.5x ↑ 36: 6.3 ↖ 37: 8.6 → 38: 5.0 ↗ 39: 8.2 ↑ 40: 10.4x ↖</p> <p>Series 79 (2x) 278 (2x)</p>
<p>60 Shots</p>	<p>41: 3.2 ↓ 42: 8.5 ↑ 43: 6.3 ↗ 44: 3.8 ↗ 45: 9.8 ↓ 46: 8.9 ↗ 47: 6.6 ↗ 48: 7.0 → 49: 5.9 ↗ 50: 8.2 ↓</p> <p>Series 63 (0x) 341 (2x)</p>	<p>60 Shots</p>	<p>51: 5.5 ↑ 52: 10.1 ↑ 53: 7.2 ↖ 54: 6.1 ↓ 55: 10.8x ↑ 56: 9.9 ← 57: 9.6 ↖ 58: 8.2 ↗ 59: 9.9 ↑ 60: 6.8 ↘</p> <p>Series 79 (1x) 420 (3x)</p>

Relay 1	Lane 8	MARKEWICZ Alan
-------------------	------------------	-----------------------

2023 AHA Memorial	AB	SR	MP
-------------------	----	----	----

18.11.2023	2023 Memorial Q	Alberta Handgun Association
------------	-----------------	-----------------------------

Comment	Signature
---------	-----------

<p>Sight</p>	<table border="1" style="width:100%; border-collapse: collapse;"> <tr><td>1:</td><td>9.4</td><td>↗</td></tr> <tr><td>2:</td><td>10.2</td><td>↖</td></tr> <tr><td>3:</td><td>7.2</td><td>↖</td></tr> <tr><td>4:</td><td>8.8</td><td>←</td></tr> <tr><td>5:</td><td>10.5x</td><td>↓</td></tr> <tr><td>6:</td><td>9.1</td><td>→</td></tr> <tr><td>7:</td><td>9.7</td><td>↗</td></tr> <tr><td>8:</td><td>8.9</td><td>↗</td></tr> <tr><td>9:</td><td>9.2</td><td>↙</td></tr> <tr><td>10:</td><td>9.4</td><td>↗</td></tr> <tr><td colspan="2">Series</td><td>88 (1x)</td></tr> <tr><td colspan="2"></td><td>0 (0x)</td></tr> </table>	1:	9.4	↗	2:	10.2	↖	3:	7.2	↖	4:	8.8	←	5:	10.5x	↓	6:	9.1	→	7:	9.7	↗	8:	8.9	↗	9:	9.2	↙	10:	9.4	↗	Series		88 (1x)			0 (0x)	<p>Sight</p>	<table border="1" style="width:100%; border-collapse: collapse;"> <tr><td>11:</td><td>10.3</td><td>↖</td></tr> <tr><td>12:</td><td>9.8</td><td>↑</td></tr> <tr><td colspan="2">Series</td><td>19 (0x)</td></tr> <tr><td colspan="2"></td><td>0 (0x)</td></tr> </table>	11:	10.3	↖	12:	9.8	↑	Series		19 (0x)			0 (0x)																								
1:	9.4	↗																																																																									
2:	10.2	↖																																																																									
3:	7.2	↖																																																																									
4:	8.8	←																																																																									
5:	10.5x	↓																																																																									
6:	9.1	→																																																																									
7:	9.7	↗																																																																									
8:	8.9	↗																																																																									
9:	9.2	↙																																																																									
10:	9.4	↗																																																																									
Series		88 (1x)																																																																									
		0 (0x)																																																																									
11:	10.3	↖																																																																									
12:	9.8	↑																																																																									
Series		19 (0x)																																																																									
		0 (0x)																																																																									
<p>60 Shots</p>	<table border="1" style="width:100%; border-collapse: collapse;"> <tr><td>1:</td><td>8.1</td><td>←</td></tr> <tr><td>2:</td><td>8.6</td><td>←</td></tr> <tr><td>3:</td><td>8.5</td><td>←</td></tr> <tr><td>4:</td><td>9.7</td><td>↓</td></tr> <tr><td>5:</td><td>9.5</td><td>←</td></tr> <tr><td>6:</td><td>10.2</td><td>↗</td></tr> <tr><td>7:</td><td>8.5</td><td>→</td></tr> <tr><td>8:</td><td>10.2</td><td>↓</td></tr> <tr><td>9:</td><td>8.4</td><td>↓</td></tr> <tr><td>10:</td><td>9.1</td><td>↙</td></tr> <tr><td colspan="2">Series</td><td>87 (0x)</td></tr> <tr><td colspan="2"></td><td>87 (0x)</td></tr> </table>	1:	8.1	←	2:	8.6	←	3:	8.5	←	4:	9.7	↓	5:	9.5	←	6:	10.2	↗	7:	8.5	→	8:	10.2	↓	9:	8.4	↓	10:	9.1	↙	Series		87 (0x)			87 (0x)	<p>60 Shots</p>	<table border="1" style="width:100%; border-collapse: collapse;"> <tr><td>11:</td><td>9.1</td><td>←</td></tr> <tr><td>12:</td><td>9.3</td><td>↑</td></tr> <tr><td>13:</td><td>10.6x</td><td>↖</td></tr> <tr><td>14:</td><td>8.1</td><td>↑</td></tr> <tr><td>15:</td><td>8.4</td><td>↙</td></tr> <tr><td>16:</td><td>8.0</td><td>←</td></tr> <tr><td>17:</td><td>9.3</td><td>→</td></tr> <tr><td>18:</td><td>9.6</td><td>↑</td></tr> <tr><td>19:</td><td>9.4</td><td>↑</td></tr> <tr><td>20:</td><td>9.6</td><td>↓</td></tr> <tr><td colspan="2">Series</td><td>88 (1x)</td></tr> <tr><td colspan="2"></td><td>175 (1x)</td></tr> </table>	11:	9.1	←	12:	9.3	↑	13:	10.6x	↖	14:	8.1	↑	15:	8.4	↙	16:	8.0	←	17:	9.3	→	18:	9.6	↑	19:	9.4	↑	20:	9.6	↓	Series		88 (1x)			175 (1x)
1:	8.1	←																																																																									
2:	8.6	←																																																																									
3:	8.5	←																																																																									
4:	9.7	↓																																																																									
5:	9.5	←																																																																									
6:	10.2	↗																																																																									
7:	8.5	→																																																																									
8:	10.2	↓																																																																									
9:	8.4	↓																																																																									
10:	9.1	↙																																																																									
Series		87 (0x)																																																																									
		87 (0x)																																																																									
11:	9.1	←																																																																									
12:	9.3	↑																																																																									
13:	10.6x	↖																																																																									
14:	8.1	↑																																																																									
15:	8.4	↙																																																																									
16:	8.0	←																																																																									
17:	9.3	→																																																																									
18:	9.6	↑																																																																									
19:	9.4	↑																																																																									
20:	9.6	↓																																																																									
Series		88 (1x)																																																																									
		175 (1x)																																																																									
<p>60 Shots</p>	<table border="1" style="width:100%; border-collapse: collapse;"> <tr><td>21:</td><td>9.1</td><td>↗</td></tr> <tr><td>22:</td><td>8.3</td><td>↑</td></tr> <tr><td>23:</td><td>9.3</td><td>↖</td></tr> <tr><td>24:</td><td>9.6</td><td>↗</td></tr> <tr><td>25:</td><td>10.0</td><td>↙</td></tr> <tr><td>26:</td><td>7.9</td><td>↙</td></tr> <tr><td>27:</td><td>10.5x</td><td>→</td></tr> <tr><td>28:</td><td>9.9</td><td>↗</td></tr> <tr><td>29:</td><td>10.1</td><td>↗</td></tr> <tr><td>30:</td><td>9.5</td><td>↘</td></tr> <tr><td colspan="2">Series</td><td>90 (1x)</td></tr> <tr><td colspan="2"></td><td>265 (2x)</td></tr> </table>	21:	9.1	↗	22:	8.3	↑	23:	9.3	↖	24:	9.6	↗	25:	10.0	↙	26:	7.9	↙	27:	10.5x	→	28:	9.9	↗	29:	10.1	↗	30:	9.5	↘	Series		90 (1x)			265 (2x)	<p>60 Shots</p>	<table border="1" style="width:100%; border-collapse: collapse;"> <tr><td>31:</td><td>9.6</td><td>←</td></tr> <tr><td>32:</td><td>8.4</td><td>↑</td></tr> <tr><td>33:</td><td>9.6</td><td>↑</td></tr> <tr><td>34:</td><td>8.1</td><td>↗</td></tr> <tr><td>35:</td><td>9.9</td><td>↗</td></tr> <tr><td>36:</td><td>9.5</td><td>↖</td></tr> <tr><td>37:</td><td>9.3</td><td>↑</td></tr> <tr><td>38:</td><td>8.6</td><td>↙</td></tr> <tr><td>39:</td><td>7.9</td><td>↖</td></tr> <tr><td>40:</td><td>10.1</td><td>↖</td></tr> <tr><td colspan="2">Series</td><td>86 (0x)</td></tr> <tr><td colspan="2"></td><td>351 (2x)</td></tr> </table>	31:	9.6	←	32:	8.4	↑	33:	9.6	↑	34:	8.1	↗	35:	9.9	↗	36:	9.5	↖	37:	9.3	↑	38:	8.6	↙	39:	7.9	↖	40:	10.1	↖	Series		86 (0x)			351 (2x)
21:	9.1	↗																																																																									
22:	8.3	↑																																																																									
23:	9.3	↖																																																																									
24:	9.6	↗																																																																									
25:	10.0	↙																																																																									
26:	7.9	↙																																																																									
27:	10.5x	→																																																																									
28:	9.9	↗																																																																									
29:	10.1	↗																																																																									
30:	9.5	↘																																																																									
Series		90 (1x)																																																																									
		265 (2x)																																																																									
31:	9.6	←																																																																									
32:	8.4	↑																																																																									
33:	9.6	↑																																																																									
34:	8.1	↗																																																																									
35:	9.9	↗																																																																									
36:	9.5	↖																																																																									
37:	9.3	↑																																																																									
38:	8.6	↙																																																																									
39:	7.9	↖																																																																									
40:	10.1	↖																																																																									
Series		86 (0x)																																																																									
		351 (2x)																																																																									
<p>60 Shots</p>	<table border="1" style="width:100%; border-collapse: collapse;"> <tr><td>41:</td><td>9.0</td><td>←</td></tr> <tr><td>42:</td><td>10.5x</td><td>→</td></tr> <tr><td>43:</td><td>10.0</td><td>→</td></tr> <tr><td>44:</td><td>8.5</td><td>←</td></tr> <tr><td>45:</td><td>9.8</td><td>↗</td></tr> <tr><td>46:</td><td>9.4</td><td>↓</td></tr> <tr><td>47:</td><td>9.9</td><td>↗</td></tr> <tr><td>48:</td><td>7.7</td><td>↗</td></tr> <tr><td>49:</td><td>9.6</td><td>←</td></tr> <tr><td>50:</td><td>8.9</td><td>↓</td></tr> <tr><td colspan="2">Series</td><td>88 (1x)</td></tr> <tr><td colspan="2"></td><td>439 (3x)</td></tr> </table>	41:	9.0	←	42:	10.5x	→	43:	10.0	→	44:	8.5	←	45:	9.8	↗	46:	9.4	↓	47:	9.9	↗	48:	7.7	↗	49:	9.6	←	50:	8.9	↓	Series		88 (1x)			439 (3x)	<p>60 Shots</p>	<table border="1" style="width:100%; border-collapse: collapse;"> <tr><td>51:</td><td>9.2</td><td>↖</td></tr> <tr><td>52:</td><td>9.2</td><td>↖</td></tr> <tr><td>53:</td><td>7.0</td><td>↗</td></tr> <tr><td>54:</td><td>10.5x</td><td>→</td></tr> <tr><td>55:</td><td>10.4x</td><td>←</td></tr> <tr><td>56:</td><td>9.8</td><td>↓</td></tr> <tr><td>57:</td><td>9.9</td><td>↑</td></tr> <tr><td>58:</td><td>9.6</td><td>←</td></tr> <tr><td>59:</td><td>10.2</td><td>↑</td></tr> <tr><td>60:</td><td>7.7</td><td>↙</td></tr> <tr><td colspan="2">Series</td><td>89 (2x)</td></tr> <tr><td colspan="2"></td><td>528 (5x)</td></tr> </table>	51:	9.2	↖	52:	9.2	↖	53:	7.0	↗	54:	10.5x	→	55:	10.4x	←	56:	9.8	↓	57:	9.9	↑	58:	9.6	←	59:	10.2	↑	60:	7.7	↙	Series		89 (2x)			528 (5x)
41:	9.0	←																																																																									
42:	10.5x	→																																																																									
43:	10.0	→																																																																									
44:	8.5	←																																																																									
45:	9.8	↗																																																																									
46:	9.4	↓																																																																									
47:	9.9	↗																																																																									
48:	7.7	↗																																																																									
49:	9.6	←																																																																									
50:	8.9	↓																																																																									
Series		88 (1x)																																																																									
		439 (3x)																																																																									
51:	9.2	↖																																																																									
52:	9.2	↖																																																																									
53:	7.0	↗																																																																									
54:	10.5x	→																																																																									
55:	10.4x	←																																																																									
56:	9.8	↓																																																																									
57:	9.9	↑																																																																									
58:	9.6	←																																																																									
59:	10.2	↑																																																																									
60:	7.7	↙																																																																									
Series		89 (2x)																																																																									
		528 (5x)																																																																									

Relay 1	Lane 10	WAKARYK Rhianna
--------------------------	--------------------------	------------------------

2023 AHA Memorial	AB	JR	WR
-------------------	----	----	----

18.11.2023	2023 Memorial Q	Alberta Handgun Association
------------	-----------------	-----------------------------

Comment	Signature
---------	-----------

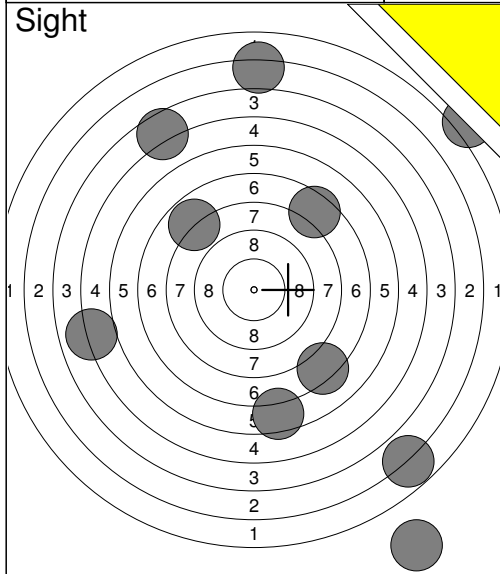

1:	6.5	↓
2:	4.6	↗
3:	7.3	↘
4:	7.5	↗
5:	3.1	↑
6:	1.4	↗
7:	2.8	↘
8:	5.0	←
9:	7.9	↗
10:	0.0	↘
Series	46.1	
	0.0	

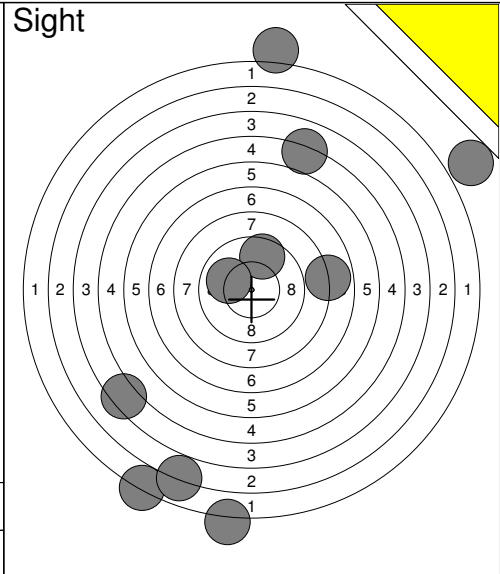

11:	9.6	↑
12:	7.9	→
13:	1.7	↓
14:	1.4	↑
15:	1.9	↓
16:	5.0	↑
17:	2.9	↓
18:	0.0	↗
19:	4.3	↙
20:	10.0	←
Series	44.7	
	0.0	

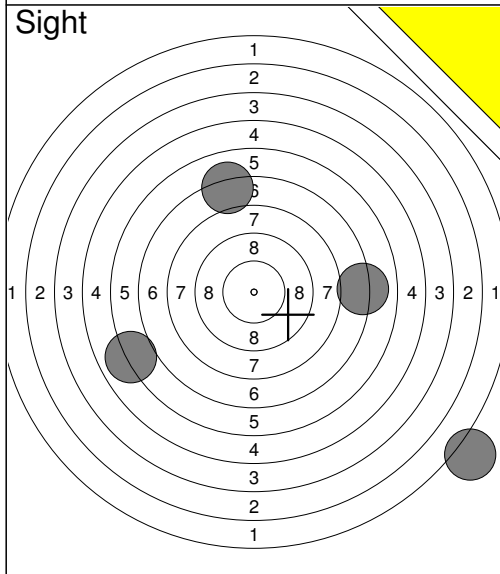

21:	7.1	↑
22:	1.3	↘
23:	7.1	→
24:	6.0	↙
Series	21.5	
	0.0	

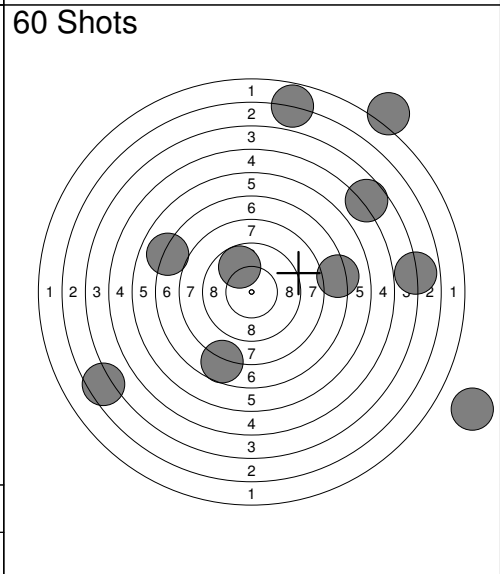

1:	1.4	↗
2:	4.7	↗
3:	3.5	↙
4:	7.7	↓
5:	7.2	→
6:	2.8	↑
7:	7.0	←
8:	9.8	↑
9:	0.0	↘
10:	3.9	→
Series	48.0	
	48.0	

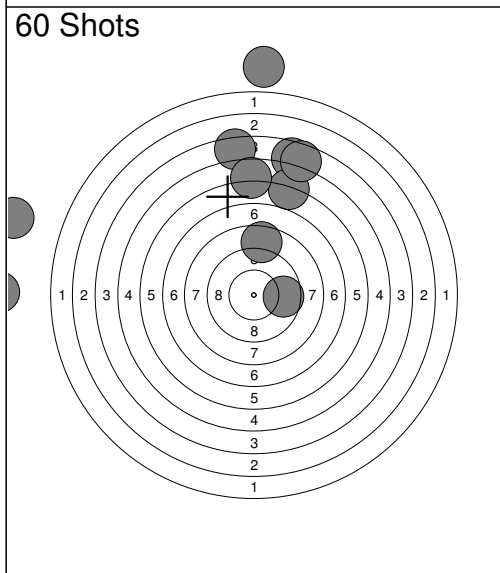

11:	0.0	←
12:	4.6	↑
13:	0.0	←
14:	6.0	↑
15:	0.0	↑
16:	8.5	↑
17:	4.4	↑
18:	4.6	↑
19:	9.6	→
20:	5.7	↑
Series	43.4	
	91.4	

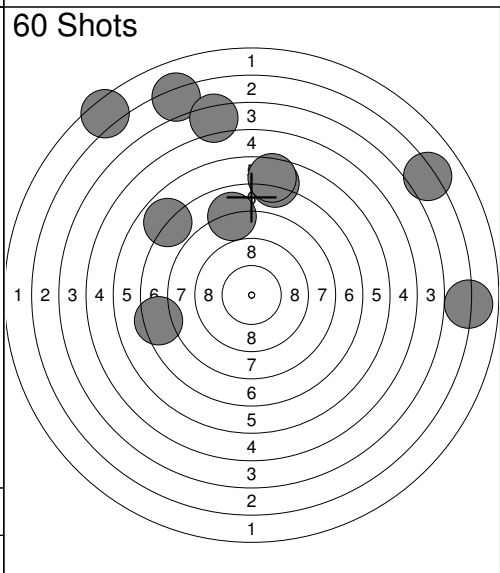

21:	7.4	←
22:	2.3	↖
23:	6.7	↑
24:	6.9	↖
25:	2.9	→
26:	3.2	↑
27:	3.1	↗
28:	8.0	↑
29:	4.3	↑
30:	6.6	↑
Series	51.4	
	142.8	

60 Shots

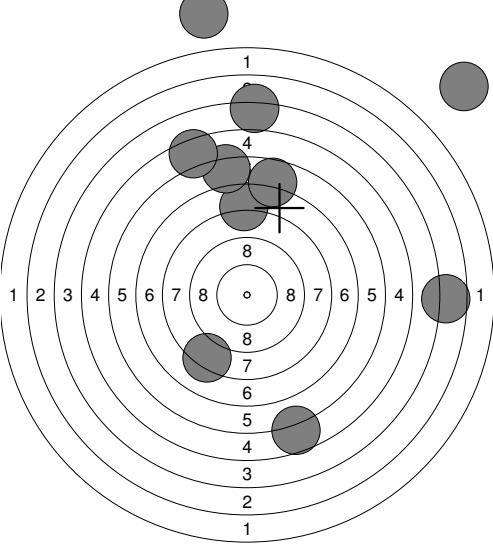

- 31: 7.7 ↑
- 32: 0.0 ↗
- 33: 3.6 →
- 34: 6.2 ↑
- 35: 5.7 ↓
- 36: 4.1 ↑
- 37: 0.0 ↑
- 38: 8.2 ↙
- 39: 6.7 ↑
- 40: 5.4 ↗

Series 47.6
190.4

60 Shots

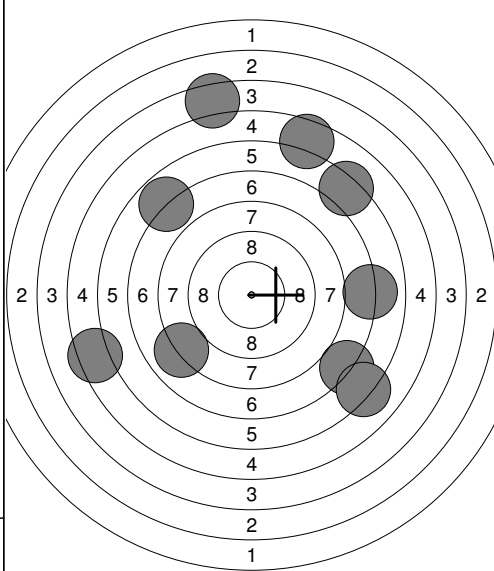

- 41: 7.0 ↘
- 42: 8.0 ↙
- 43: 0.0 ↓
- 44: 7.0 →
- 45: 6.1 ↘
- 46: 6.8 ↗
- 47: 4.4 ↑
- 48: 5.4 ←
- 49: 6.2 ↗
- 50: 5.6 ↑

Series 56.5
246.9

60 Shots

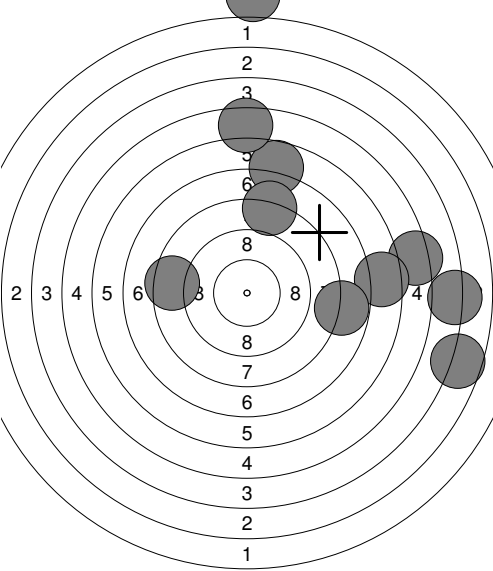

- 51: 8.4 ←
- 52: 4.1 →
- 53: 5.3 →
- 54: 6.7 ↑
- 55: 6.5 →
- 56: 3.6 ↘
- 57: 7.8 →
- 58: 8.1 ↑
- 59: 5.4 ↑
- 60: 1.1 ↑

Series 57.0
303.9

Comment	Signature		
---------	-----------	--	--

<p>Sight</p>	<p>Sight</p>
<p>60 Shots</p>	<p>60 Shots</p>
<p>60 Shots</p>	<p>60 Shots</p>
<p>60 Shots</p>	<p>60 Shots</p>

Relay 1	Lane 12	EVANYSHYN-ROBB Jacob		
-------------------	-------------------	-----------------------------	--	--

2023 AHA Memorial	AB	JR	MR
-------------------	----	----	----

18.11.2023	2023 Memorial Q	Alberta Handgun Association	
------------	-----------------	-----------------------------	--

Comment	Signature		
---------	-----------	--	--

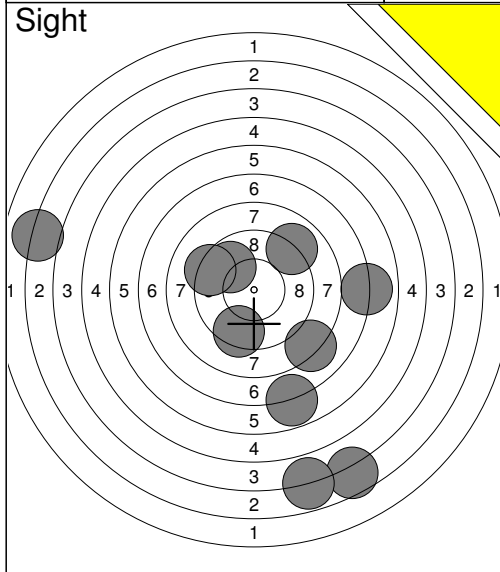

Series	69.9
	0.0

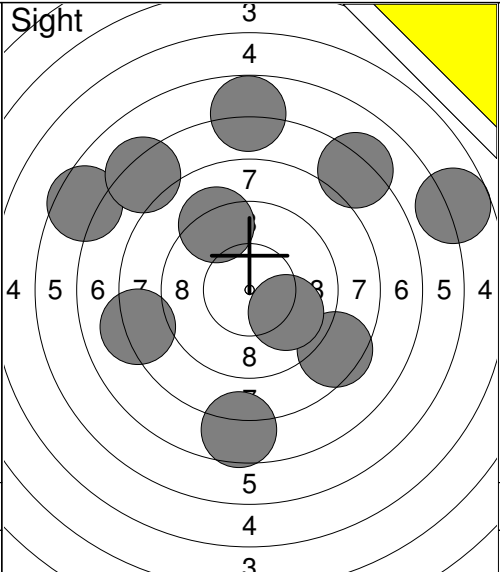

Series	76.8
	0.0

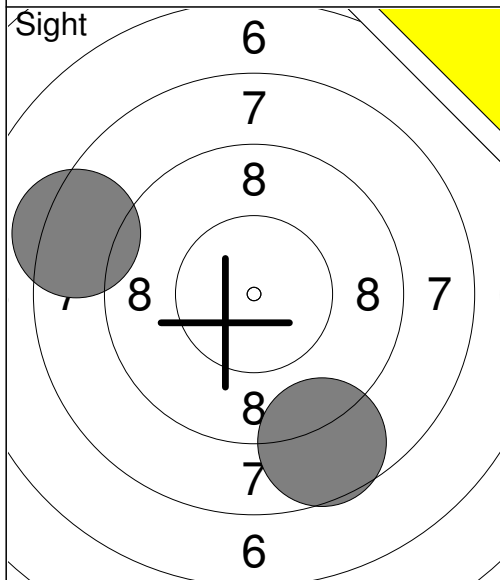

Series	17.0
	0.0

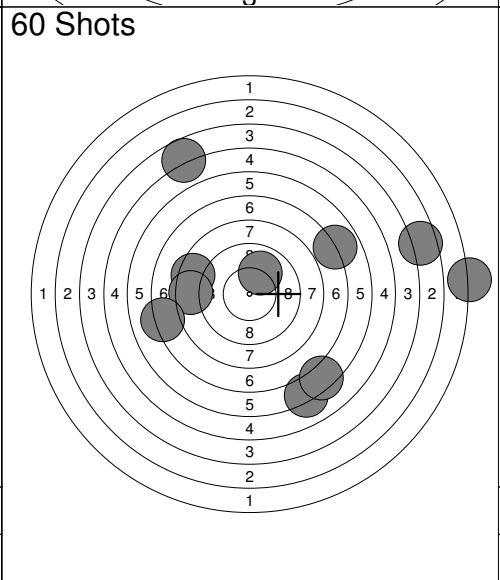

Series	63.5
	63.5

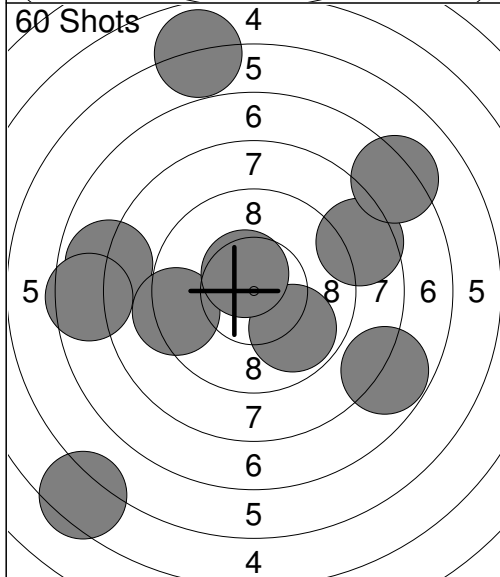

Series	80.2
	143.7

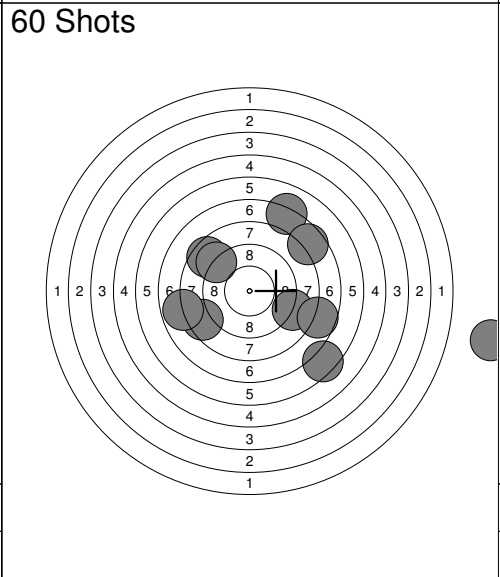

Series	71.5
	215.2

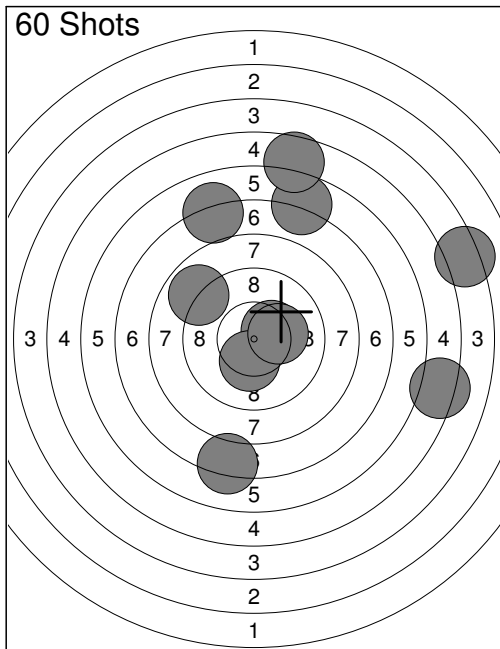

31:	4.3	➔
32:	8.9	↖
33:	10.4x	➔
34:	7.0	↑
35:	5.3	➔
36:	6.7	↑
37:	10.3x	↓
38:	5.6	↑
39:	7.2	↓
40:	10.2x	➔
Series	75.9	
	291.1	

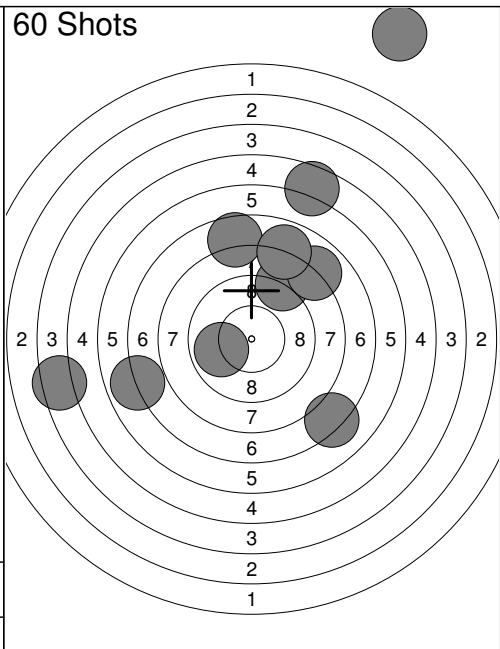

41:	8.9	↗
42:	5.6	↗
43:	9.9	↖
44:	7.2	↘
45:	7.6	↑
46:	6.9	↖
47:	7.9	↗
48:	0.0	↗
49:	4.4	↖
50:	7.9	↗
Series	66.3	
	357.4	

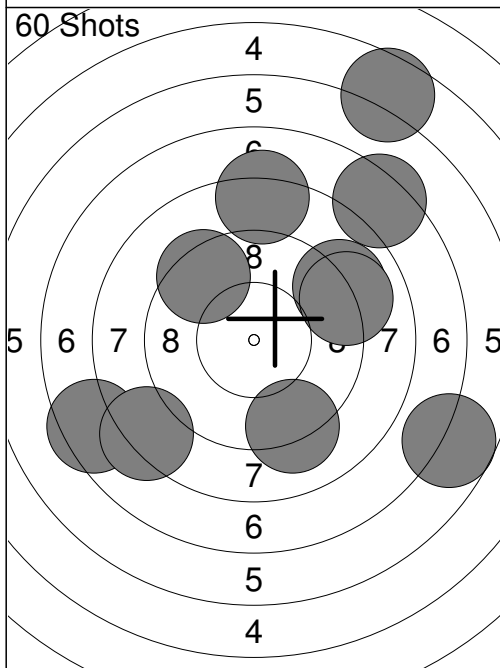

51:	8.2	↑
52:	9.4	↖
53:	7.4	↗
54:	9.0	↗
55:	6.7	↘
56:	9.0	➔
57:	7.5	↖
58:	9.1	↓
59:	5.6	↗
60:	8.2	↖
Series	80.1	
	437.5	

--	--	--

Relay 2	Lane 2	WANG Hejia (zack)	
-------------------	------------------	--------------------------	--

2023 AHA Memorial	BC	JR	MP
-------------------	----	----	----

18.11.2023	2023 Memorial Q	Alberta Handgun Association	
------------	-----------------	-----------------------------	--

Comment	Signature		
---------	-----------	--	--

	1: 9.7 ↖		11: 10.2 ↗
	2: 9.6 ↙		12: 10.1 ↙
	3: 10.3 ↗		13: 9.2 ↓
	4: 8.9 →		14: 9.9 ↓
	5: 9.6 ↗		15: 10.3 ↓
	6: 9.4 ↖		16: 9.7 ↑
	7: 8.8 ↗		17: 10.4x ↖
	8: 8.4 ↓		18: 8.9 ↓
	9: 8.8 ↙		19: 9.4 ↙
	10: 9.9 →		20: 9.1 ↑
Series	87 (0x)	Series	93 (1x)
	0 (0x)		0 (0x)

	1: 10.1 ↖		11: 7.5 ↙
	2: 10.3 ↖		12: 9.8 ↑
	3: 9.5 ↓		13: 10.3 ↓
	4: 8.7 ↓		14: 9.4 ↓
	5: 9.8 ↓		15: 9.7 ↖
	6: 9.8 ↗		16: 10.0 ↙
	7: 9.1 ↑		17: 9.8 ↙
	8: 9.2 ↑		18: 9.6 ↖
	9: 10.3 ↓		19: 10.4x ↖
	10: 10.1 ↑		20: 9.9 ↗
Series	93 (0x)	Series	91 (1x)
	93 (0x)		184 (1x)

	21: 10.2 ↓		31: 10.3 ↓
	22: 9.0 ↗		32: 10.5x ↗
	23: 9.2 ↗		33: 9.4 ↖
	24: 9.0 ↗		34: 8.6 ↖
	25: 8.6 ↓		35: 9.4 ↓
	26: 7.9 ↓		36: 10.5x ↖
	27: 8.3 ↖		37: 10.4x ↗
	28: 9.6 ↓		38: 9.7 ↑
	29: 8.6 →		39: 7.7 ↙
	30: 9.1 ↗		40: 10.2 →
Series	86 (0x)	Series	92 (3x)
	270 (1x)		362 (4x)

	41: 10.3 ↓		51: 9.8 ↖
	42: 10.4 ↗		52: 9.9 ↖
	43: 8.5 ↖		53: 10.2 →
	44: 8.9 ↓		54: 10.2 ↖
	45: 10.2 ↖		55: 8.3 ↗
	46: 7.5 ↓		56: 9.8 ↖
	47: 9.9 ↖		57: 9.0 ↓
	48: 9.1 ↓		58: 9.4 ↓
	49: 10.0 ↖		59: 10.7x ↗
	50: 10.0 ↗		60: 7.1 ↖
Series	91 (0x)	Series	90 (1x)
	453 (4x)		543 (5x)

Relay 2	Lane 3	SUN Xihan (henry)
-------------------	------------------	--------------------------

2023 AHA Memorial	BC	JR	MP
-------------------	----	----	----

18.11.2023	2023 Memorial Q	Alberta Handgun Association
------------	-----------------	-----------------------------

Comment	Signature
---------	-----------

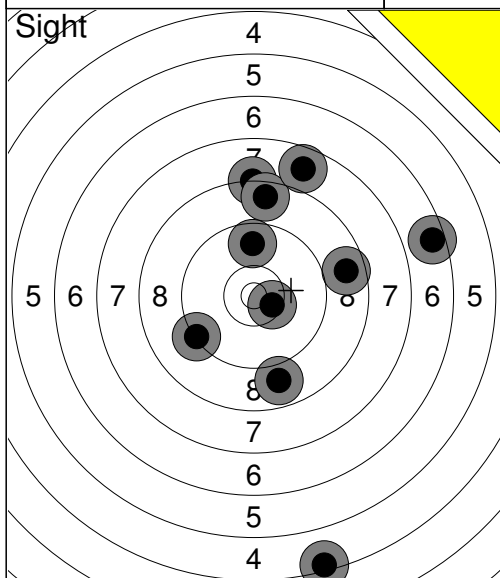

1:	8.9	↓
2:	8.2	↑
3:	10.5x	⇒
4:	8.7	→
5:	9.3	↙
6:	8.6	↑
7:	7.7	↑
8:	4.4	↓
9:	6.5	→
10:	9.7	↑
Series	77 (1x)	
	0 (0x)	

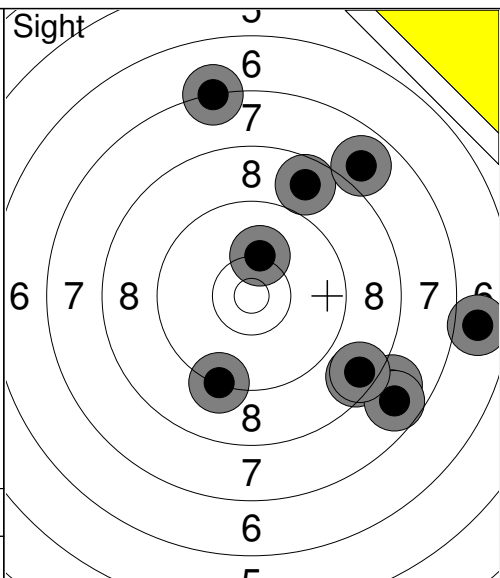

11:	8.6	↘
12:	7.9	↘
13:	6.8	→
14:	7.7	↘
15:	10.2	↑
16:	7.2	↑
17:	9.3	↓
18:	8.7	↑
19:	7.9	↗
20:	8.5	↘
Series	77 (0x)	
	0 (0x)	

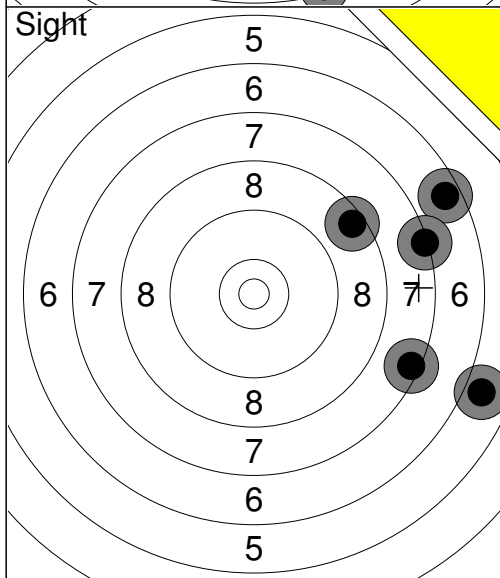

21:	5.9	⇒
22:	6.5	↗
23:	7.4	⇒
24:	7.3	→
25:	8.5	↗
Series	33 (0x)	
	0 (0x)	

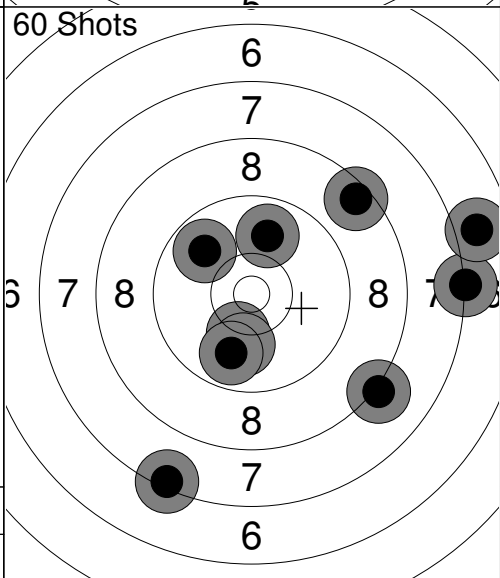

1:	8.1	↘
2:	10.2	↓
3:	7.2	→
4:	6.8	→
5:	8.5	↗
6:	10.0	↓
7:	7.4	↓
8:	9.9	↓
9:	9.9	↑
10:	9.8	↖
Series	83 (0x)	
	83 (0x)	

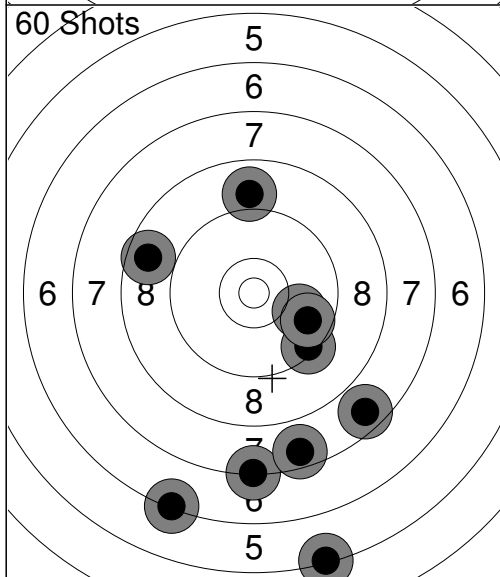

11:	7.3	↓
12:	8.7	↖
13:	9.4	↘
14:	10.0	⇒
15:	7.6	↓
16:	8.9	↑
17:	5.3	↓
18:	6.3	↓
19:	9.7	⇒
20:	7.6	↘
Series	76 (0x)	
	159 (0x)	

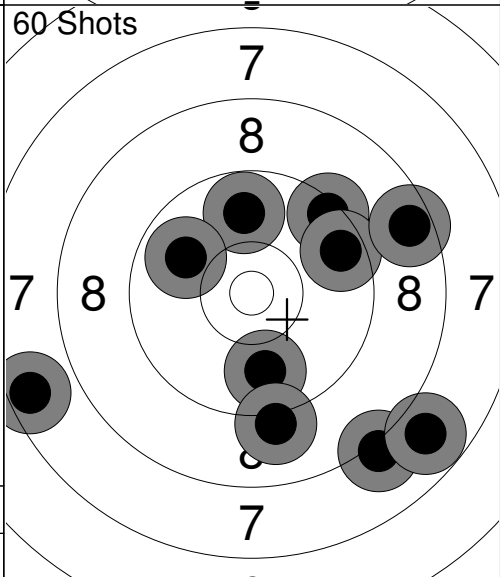

21:	7.5	↖
22:	9.8	↓
23:	9.4	↗
24:	8.1	↘
25:	9.6	↗
26:	9.8	↑
27:	8.5	→
28:	7.8	↘
29:	9.1	↓
30:	9.9	↖
Series	84 (0x)	
	243 (0x)	

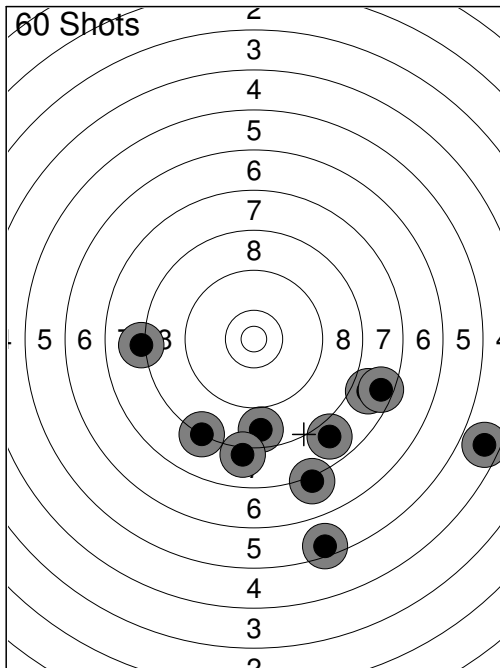

31:	5.5	↓
32:	8.7	↓
33:	8.1	←
34:	7.1	↓
35:	7.8	⇒
36:	8.1	↓
37:	7.5	⇒
38:	8.2	↓
39:	4.6	⇒
40:	7.9	↓
Series	69 (0x)	
	312 (0x)	

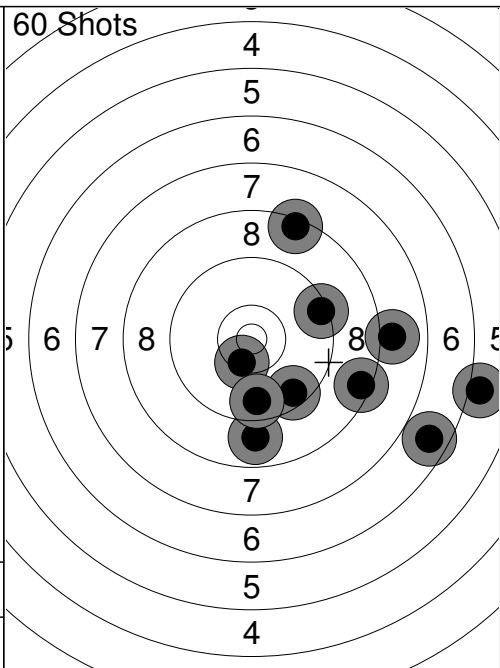

41:	10.4x	↓
42:	9.5	↓
43:	8.4	⇒
44:	8.4	↑
45:	9.4	⇒
46:	8.0	→
47:	8.9	↓
48:	6.6	⇒
49:	9.6	↓
50:	6.0	→
Series	81 (1x)	
	393 (1x)	

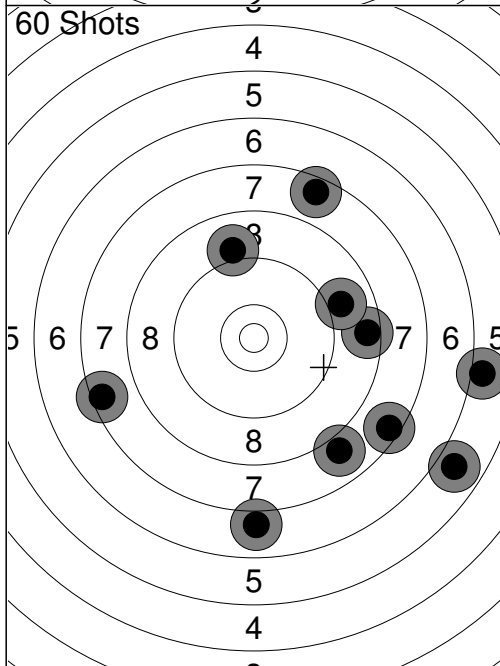

51:	6.9	↓
52:	9.0	↑
53:	7.5	←
54:	7.5	⇒
55:	6.0	→
56:	5.8	↓
57:	7.9	↓
58:	8.5	→
59:	7.6	↑
60:	8.9	⇒
Series	70 (0x)	
	463 (1x)	

--	--

Relay **2** Lane **4** **FU Daniel yuhui**

2023 AHA Memorial BC JR MP

18.11.2023 2023 Memorial Q Alberta Handgun Association

Comment Signature

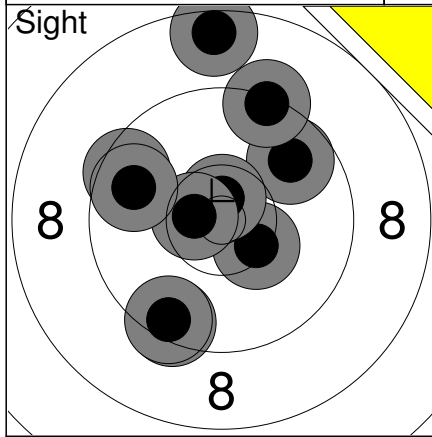

1:	10.4x	↘
2:	9.5	↙
3:	9.8	↗
4:	10.7x	↑
5:	10.6x	←
6:	9.3	↗
7:	9.5	↙
8:	9.6	←
9:	9.7	←
10:	8.5	↑
Series	92 (3x)	
	0 (0x)	

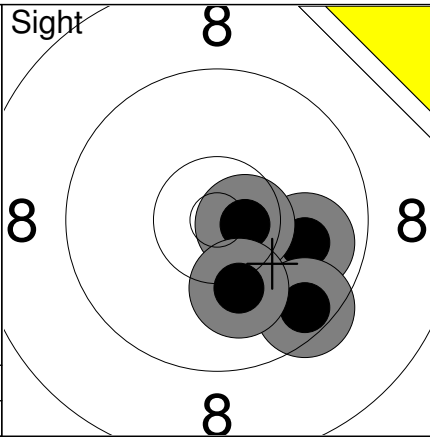

11:	9.9	↘
12:	9.5	↙
13:	10.6x	↗
14:	10.1	↙
Series	38 (1x)	
	0 (0x)	

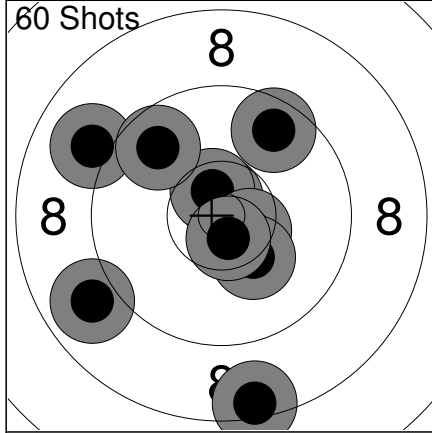

1:	10.7x	↑
2:	9.0	↗
3:	9.6	↗
4:	10.6x	↗
5:	9.7	↗
6:	8.4	↙
7:	10.5x	↙
8:	10.3	↙
9:	8.9	←
10:	10.6x	↙
Series	93 (4x)	
	93 (4x)	

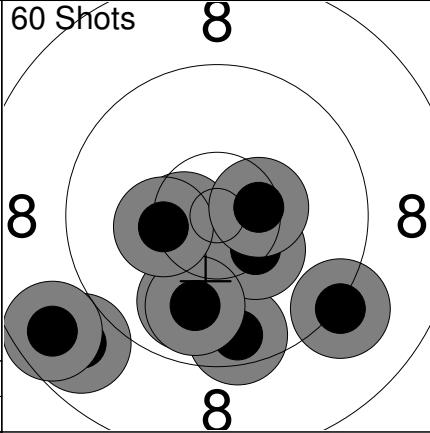

11:	9.2	↘
12:	9.9	↙
13:	9.6	↙
14:	10.6x	←
15:	10.4x	↘
16:	9.9	↙
17:	10.3	←
18:	8.8	↙
19:	10.5x	↗
20:	8.7	↙
Series	92 (3x)	
	185 (7x)	

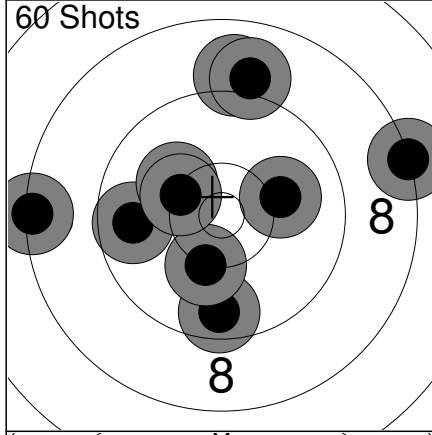

21:	9.6	↙
22:	10.1	↗
23:	8.2	↗
24:	9.0	↑
25:	9.7	←
26:	10.2	↗
27:	9.0	↑
28:	10.2	↙
29:	8.3	←
30:	10.3	↙
Series	92 (0x)	
	277 (7x)	

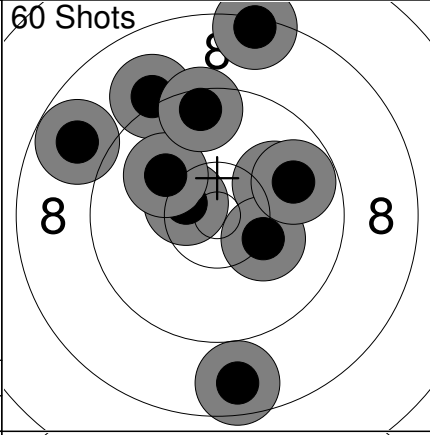

31:	10.1	↗
32:	8.8	←
33:	10.5x	←
34:	9.1	↗
35:	10.3	↗
36:	8.7	↙
37:	10.1	↗
38:	9.8	↗
39:	8.4	↑
40:	9.5	↑
Series	91 (1x)	
	368 (8x)	

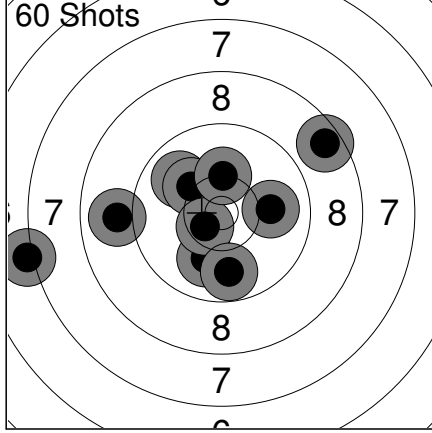

41:	8.6	↗
42:	10.0	↗
43:	9.9	↗
44:	10.2	↗
45:	10.0	↙
46:	10.5x	←
47:	8.9	←
48:	9.8	↙
49:	7.1	←
50:	10.2	↑
Series	91 (1x)	
	459 (9x)	

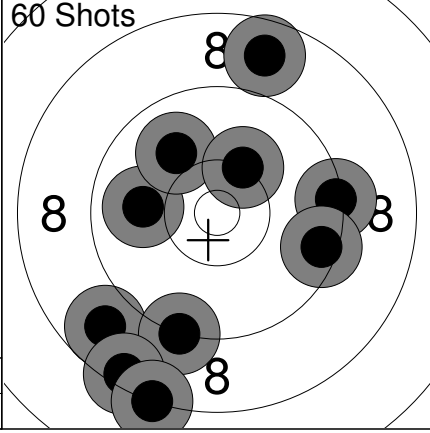

51:	9.9	←
52:	10.0	↖
53:	8.8	↙
54:	9.2	↙
55:	8.7	↑
56:	8.4	↙
57:	9.3	↗
58:	9.5	↗
59:	10.2	↗
60:	8.2	↙
Series	88 (0x)	
	547 (9x)	

Relay **2** Lane **5** **ZHOU Mo**

2023 AHA Memorial BC JR MP

18.11.2023 2023 Memorial Q Alberta Handgun Association

Comment Signature

<p>Sight</p>	<p>1: 10.2 ↓ 2: 9.4 → 3: 8.9 ↗ 4: 7.6 ↓ 5: 8.5 ↓ 6: 9.0 ← 7: 7.6 ↙ 8: 9.7 ↓ 9: 7.7 ↗ 10: 9.9 ↓</p> <p>Series 83 (0x) 0 (0x)</p>	<p>Sight</p>	<p>11: 8.8 ↖ 12: 9.7 ↙ 13: 10.0 ↑ 14: 8.7 → 15: 7.0 → 16: 9.8 ↑ 17: 9.6 ↑ 18: 9.4 ↗ 19: 8.6 ← 20: 9.6 ↗</p> <p>Series 86 (0x) 0 (0x)</p>
<p>60 Shots</p>	<p>1: 7.6 ↑ 2: 9.5 → 3: 10.0 ← 4: 5.6 ↑ 5: 8.1 ↗ 6: 9.6 ↑ 7: 8.8 ↓ 8: 9.6 → 9: 9.5 ↗ 10: 9.7 ↓</p> <p>Series 83 (0x) 83 (0x)</p>	<p>60 Shots</p>	<p>11: 9.4 ← 12: 10.1 ↗ 13: 9.3 ↗ 14: 8.6 ↖ 15: 10.8x → 16: 7.4 ↑ 17: 9.0 ↓ 18: 8.2 ← 19: 9.8 ↑ 20: 9.5 ↖</p> <p>Series 88 (1x) 171 (1x)</p>
<p>60 Shots</p>	<p>21: 7.8 ← 22: 8.6 → 23: 10.1 ↑ 24: 9.8 ↗ 25: 8.7 → 26: 9.9 ↓ 27: 8.8 ↓ 28: 9.3 ↓ 29: 10.2 ↑ 30: 10.4x →</p> <p>Series 88 (1x) 259 (2x)</p>	<p>60 Shots</p>	<p>31: 9.1 → 32: 9.4 ↓ 33: 8.8 ↗ 34: 9.5 ↓ 35: 9.6 → 36: 9.6 ↖ 37: 9.0 → 38: 7.6 ↓ 39: 7.7 ↗ 40: 8.3 ↑</p> <p>Series 84 (0x) 343 (2x)</p>
<p>60 Shots</p>	<p>41: 7.7 ← 42: 9.0 ↑ 43: 9.6 ↖ 44: 8.1 ↑ 45: 9.6 ↓ 46: 9.3 ↗ 47: 5.5 ↓ 48: 9.4 ↑ 49: 10.3 ↑ 50: 10.8x ↗</p> <p>Series 85 (1x) 428 (3x)</p>	<p>60 Shots</p>	<p>51: 9.9 ↑ 52: 6.4 ↗ 53: 8.4 ↑ 54: 10.2 ↑ 55: 8.4 → 56: 6.2 ↗ 57: 9.4 ↑ 58: 8.6 ↓ 59: 10.0 ← 60: 9.1 ↖</p> <p>Series 83 (0x) 511 (3x)</p>

Relay 2	Lane 6	NEIL Jaden
-------------------	------------------	-------------------

2023 AHA Memorial	AB	SR	MP
-------------------	----	----	----

18.11.2023	2023 Memorial Q	Alberta Handgun Association
------------	-----------------	-----------------------------

Comment	Signature
---------	-----------

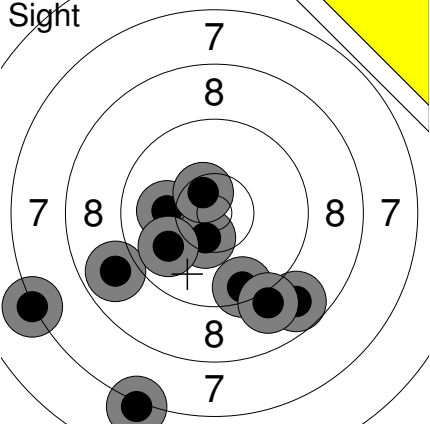
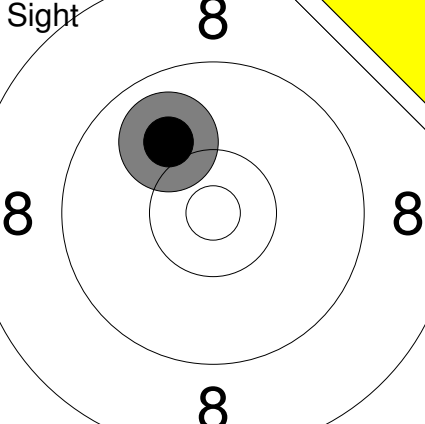
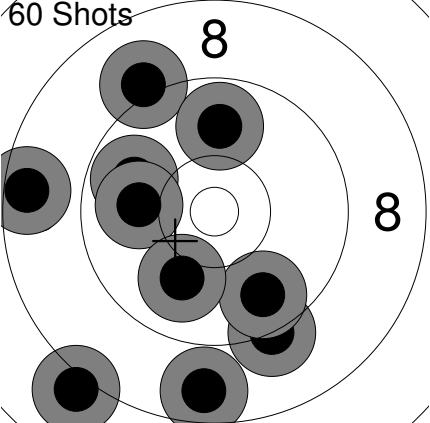
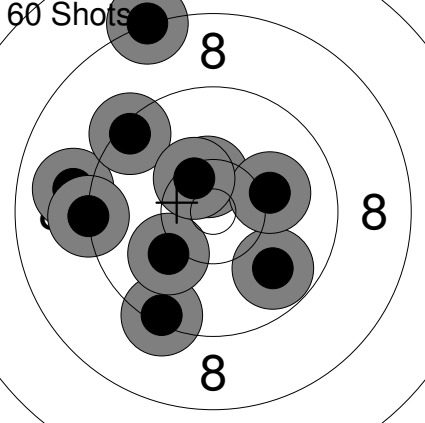
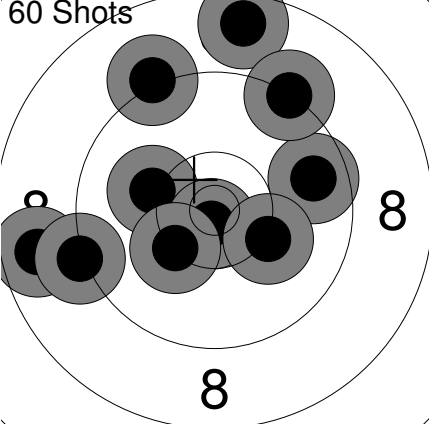
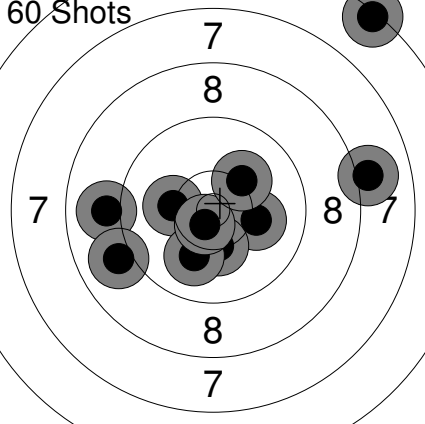
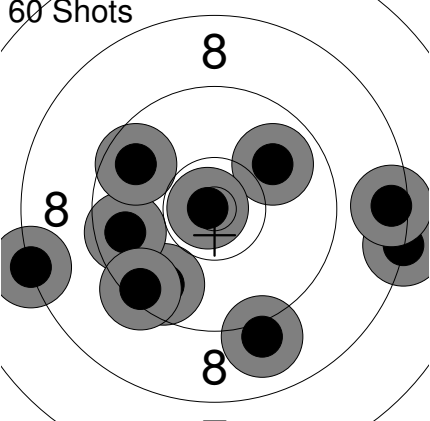
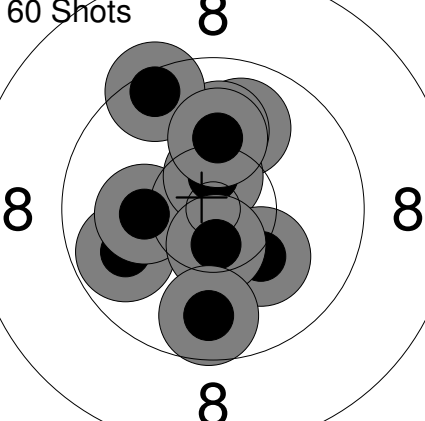
<p>Sight</p> 	<p>1: 7.2 ← 2: 8.8 ↘ 3: 9.5 ↓ 4: 8.8 ← 5: 10.1 ← 6: 9.0 ↘ 7: 10.5x ↘ 8: 7.1 ↓ 9: 9.9 ↙ 10: 10.5x ↗</p> <p>Series 87 (2x) 0 (0x)</p>	<p>Sight</p> 	<p>11: 10.0 ↗</p> <p>Series 10 (0x) 0 (0x)</p>
<p>60 Shots</p> 	<p>1: 9.8 ← 2: 8.1 ↙ 3: 9.1 ↗ 4: 9.2 ↘ 5: 8.5 ← 6: 10.0 ← 7: 9.7 ↘ 8: 10.0 ↘ 9: 9.9 ↑ 10: 8.6 ↓</p> <p>Series 89 (0x) 89 (0x)</p>	<p>60 Shots</p> 	<p>11: 9.4 ↓ 12: 9.0 ← 13: 9.8 ↘ 14: 10.5x ↑ 15: 9.2 ← 16: 8.2 ↑ 17: 9.4 ↗ 18: 10.1 → 19: 10.1 ↙ 20: 10.4x ↗</p> <p>Series 93 (2x) 182 (2x)</p>
<p>60 Shots</p> 	<p>21: 9.7 → 22: 8.6 ↑ 23: 8.7 ← 24: 9.2 ↗ 25: 9.2 ← 26: 10.1 ← 27: 10.8x ↘ 28: 10.2 → 29: 9.2 ↗ 30: 10.3 ↙</p> <p>Series 92 (1x) 274 (3x)</p>	<p>60 Shots</p> 	<p>31: 10.1 → 32: 10.2 ← 33: 9.0 ← 34: 6.3 ↗ 35: 10.3 ↓ 36: 10.0 ↓ 37: 10.7x ↘ 38: 8.0 → 39: 9.0 ← 40: 10.2 ↗</p> <p>Series 92 (1x) 366 (4x)</p>
<p>60 Shots</p> 	<p>41: 8.2 ← 42: 8.3 → 43: 9.9 ↗ 44: 9.0 ↘ 45: 9.7 ↘ 46: 9.7 ← 47: 9.4 ↘ 48: 8.5 → 49: 10.9x ← 50: 9.7 ↗</p> <p>Series 88 (1x) 454 (5x)</p>	<p>60 Shots</p> 	<p>51: 10.0 ↑ 52: 10.1 ↑ 53: 9.8 ← 54: 9.5 ↗ 55: 10.2 ← 56: 10.6x ↑ 57: 10.1 ↑ 58: 10.2 ↘ 59: 10.5x ↓ 60: 9.7 ↓</p> <p>Series 97 (2x) 551 (7x)</p>

Relay **2** Lane **7** **WICK Werner**

2023 AHA Memorial AB SR MP

18.11.2023 2023 Memorial Q Alberta Handgun Association

Comment Signature

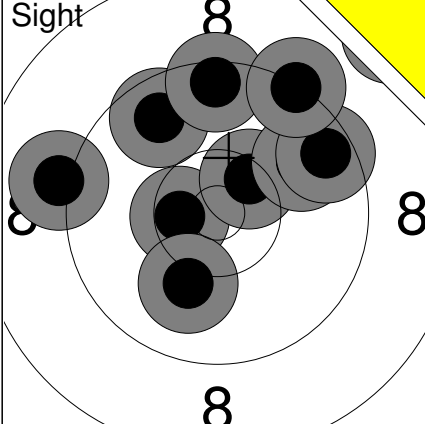
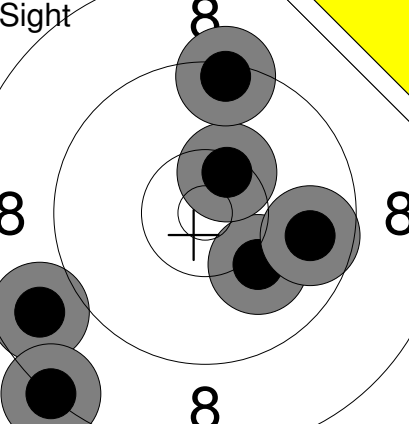
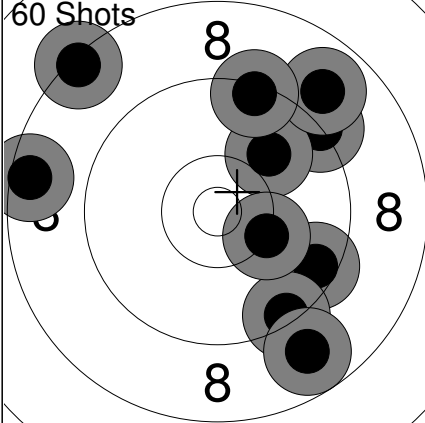
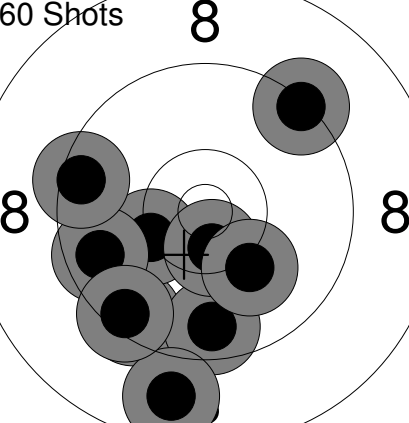
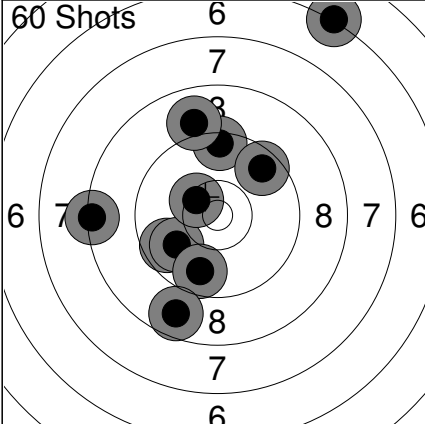
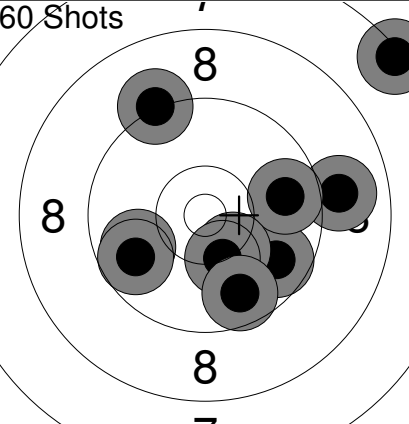
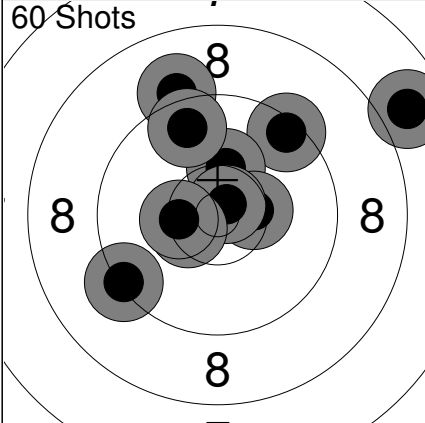
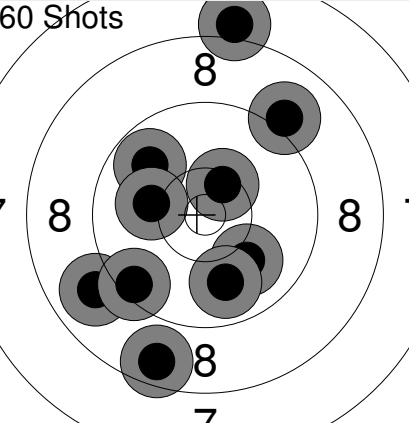
<p>Sight</p> 	<p>1: 9.7 ↗ 2: 10.5x ← 3: 10.4x ↗ 4: 9.5 ↑ 5: 10.1 ↓ 6: 9.8 ↗ 7: 9.5 ↗ 8: 8.1 ↗ 9: 9.3 ↗ 10: 9.1 ←</p> <p>Series 92 (2x) 0 (0x)</p>	<p>Sight</p> 	<p>11: 10.1 ↓ 12: 9.7 → 13: 8.8 ← 14: 8.3 ↓ 15: 10.4x ↗ 16: 9.4 ↑</p> <p>Series 54 (1x) 0 (0x)</p>
<p>60 Shots</p> 	<p>1: 9.5 → 2: 9.2 ↗ 3: 9.3 ↓ 4: 10.0 ↗ 5: 8.8 ↓ 6: 8.3 ↗ 7: 8.9 ↗ 8: 8.5 ← 9: 9.4 ↑ 10: 10.2 →</p> <p>Series 88 (0x) 88 (0x)</p>	<p>60 Shots</p> 	<p>11: 9.5 ↓ 12: 9.3 ↗ 13: 10.3 ← 14: 9.6 ↓ 15: 8.8 ↓ 16: 9.6 ← 17: 10.5x ↓ 18: 10.1 ↓ 19: 9.4 ↓ 20: 9.5 ←</p> <p>Series 92 (1x) 180 (1x)</p>
<p>60 Shots</p> 	<p>21: 9.7 ← 22: 9.9 ← 23: 9.5 ↑ 24: 8.3 ← 25: 9.6 ↗ 26: 10.4x ↗ 27: 9.7 ↓ 28: 9.0 ↑ 29: 6.2 ↗ 30: 8.7 ↓</p> <p>Series 86 (1x) 266 (2x)</p>	<p>60 Shots</p> 	<p>31: 9.7 → 32: 9.0 → 33: 9.8 → 34: 9.9 ← 35: 9.2 ↗ 36: 10.3 ↓ 37: 10.3 ↓ 38: 9.8 ← 39: 7.3 ↗ 40: 9.7 ↓</p> <p>Series 90 (0x) 356 (2x)</p>
<p>60 Shots</p> 	<p>41: 9.4 ↗ 42: 7.8 ↗ 43: 10.3 ↑ 44: 9.3 ← 45: 10.4x → 46: 9.1 ↗ 47: 10.8x ↗ 48: 10.5x ← 49: 10.4x ← 50: 9.6 ↑</p> <p>Series 93 (4x) 449 (6x)</p>	<p>60 Shots</p> 	<p>51: 8.9 ← 52: 8.6 ↓ 53: 9.4 ← 54: 9.8 ↗ 55: 10.1 ← 56: 8.0 ↑ 57: 9.0 ↗ 58: 10.4x ↗ 59: 10.0 ↓ 60: 9.9 ↓</p> <p>Series 90 (1x) 539 (7x)</p>

Relay 2	Lane 8	OLSEN Jesse	
-------------------	------------------	--------------------	--

2023 AHA Memorial	SK	SR	MP
-------------------	----	----	----

18.11.2023	2023 Memorial Q	Alberta Handgun Association	
------------	-----------------	-----------------------------	--

Comment	Signature		
---------	-----------	--	--

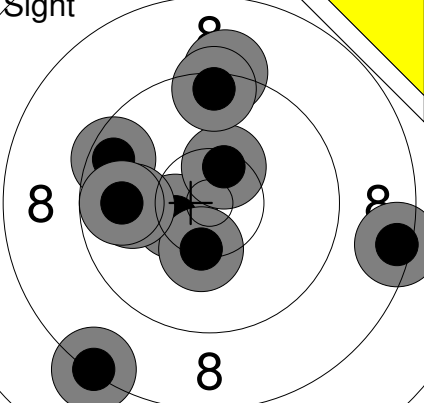
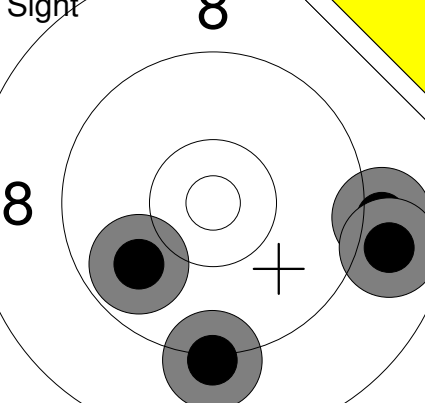
	1: 10.5x ←		11: 9.2 ↓
	2: 10.4x ↗		12: 9.0 →
	3: 10.3 ↓		13: 9.9 ↖
	4: 9.6 ←		14: 8.9 →
	5: 9.9 ←		
	6: 9.2 ↗		
	7: 9.4 ↗		
	8: 9.8 ←		
	9: 8.4 →		
	10: 8.3 ↘		
	Series 91 (2x)		Series 35 (0x)
	0 (0x)		0 (0x)

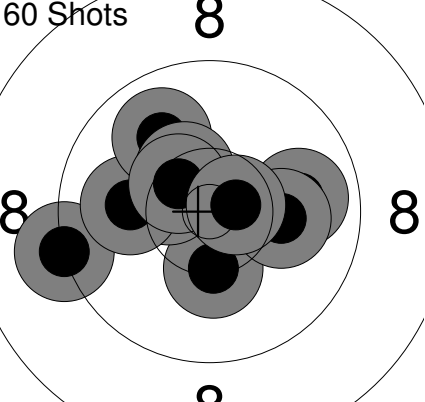
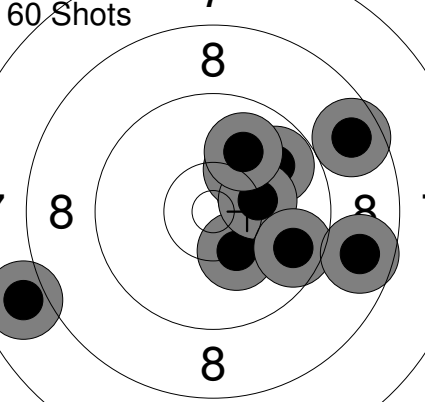
	1: 10.3 ↓		11: 10.3 →
	2: 10.5x ↗		12: 8.7 →
	3: 9.9 →		13: 10.2 ↗
	4: 9.2 ←		14: 10.3 ↓
	5: 10.0 ←		15: 9.8 ↗
	6: 9.9 ↗		16: 10.3 →
	7: 10.4x ↗		17: 7.9 ←
	8: 10.5x ↗		18: 9.7 →
	9: 10.1 →		19: 10.0 ↗
	10: 10.6x →		20: 8.7 →
	Series 97 (4x)		Series 91 (0x)
	97 (4x)		188 (4x)

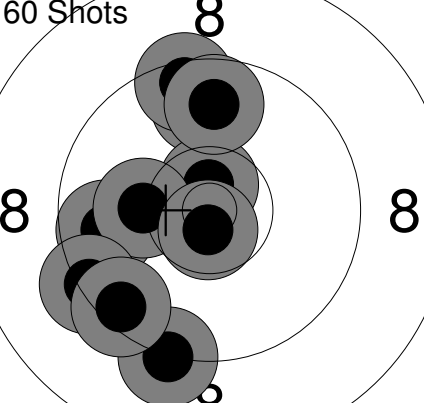
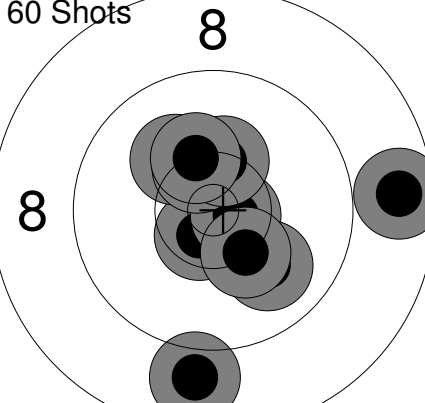
	21: 9.8 ←		31: 10.6x ↓
	22: 9.7 ↗		32: 10.7x →
	23: 9.5 ↗		33: 10.0 ↓
	24: 10.7x ↗		34: 10.2 ↗
	25: 10.2 ←		35: 10.4x ↗
	26: 9.2 ↓		36: 10.3 ↗
	27: 9.3 ←		37: 10.3 ↓
	28: 10.7x ↓		38: 10.3 ↗
	29: 9.7 ↗		39: 8.9 ↓
	30: 9.5 ↘		40: 8.7 →
	Series 93 (2x)		Series 96 (3x)
	281 (6x)		377 (9x)

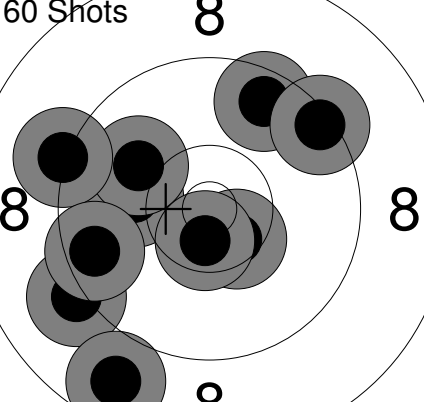
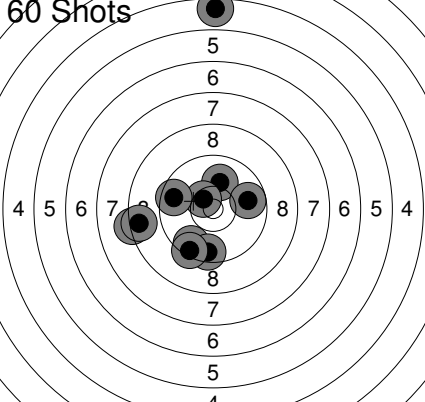
	41: 10.1 ←		51: 10.1 ↗
	42: 10.0 ↗		52: 9.6 ↓
	43: 9.1 ↖		53: 10.5x ↗
	44: 10.5x ↘		54: 9.6 ↓
	45: 9.2 ←		55: 9.8 →
	46: 10.6x ↓		56: 4.5 ↗
	47: 9.6 ↗		57: 8.3 ←
	48: 8.7 ↓		58: 8.5 ←
	49: 9.4 ↗		59: 9.6 ←
	50: 9.6 ←		60: 9.4 ↓
	Series 93 (2x)		Series 85 (1x)
	470 (11x)		555 (12x)

Relay **2** Lane **9** **ZHENG Tingxi**

2023 AHA Memorial BC JR WP

18.11.2023 2023 Memorial Q Alberta Handgun Association

Comment Signature

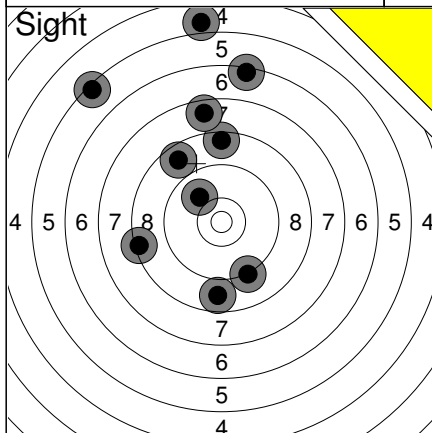

1:	8.4	←
2:	8.7	↗
3:	8.5	↑
4:	9.2	↘
5:	5.4	↗
6:	4.9	↑
7:	7.6	↑
8:	6.4	↑
9:	9.9	↗
10:	8.8	↓
Series	72 (0x)	
	0 (0x)	

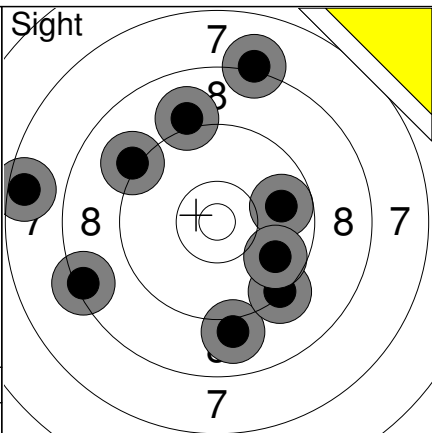

11:	9.0	↓
12:	8.4	←
13:	9.3	↘
14:	9.8	→
15:	8.1	↑
16:	9.1	↑
17:	7.5	←
18:	9.1	↗
19:	9.8	↘
Series	77 (0x)	
	0 (0x)	

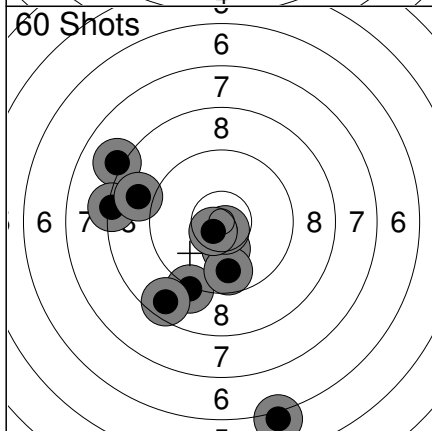

1:	8.1	←
2:	6.1	↘
3:	10.3	↘
4:	9.2	↘
5:	8.6	↘
6:	8.3	←
7:	9.8	↘
8:	10.7x	↘
9:	10.6x	↘
10:	8.9	←
Series	86 (2x)	
	86 (2x)	

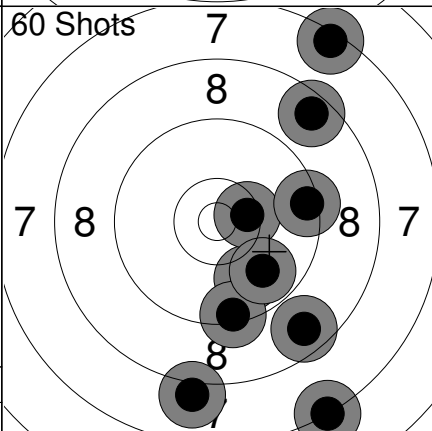

11:	8.6	↘
12:	7.4	↗
13:	7.2	↘
14:	9.9	↘
15:	10.4x	→
16:	9.4	↓
17:	8.5	↗
18:	9.4	→
19:	9.8	↘
20:	8.0	↓
Series	84 (1x)	
	170 (3x)	

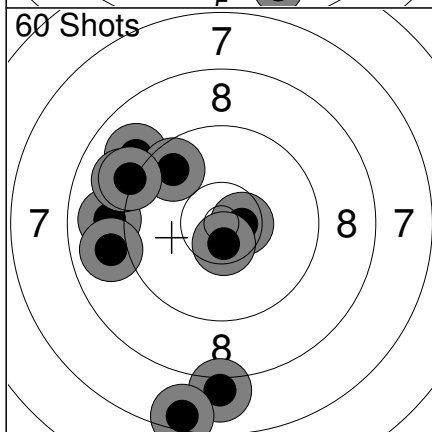

21:	9.0	↗
22:	9.7	↗
23:	9.0	←
24:	8.0	↘
25:	10.6x	→
26:	7.5	↘
27:	8.9	←
28:	9.1	↗
29:	10.6x	↘
30:	9.2	↗
Series	88 (2x)	
	258 (5x)	

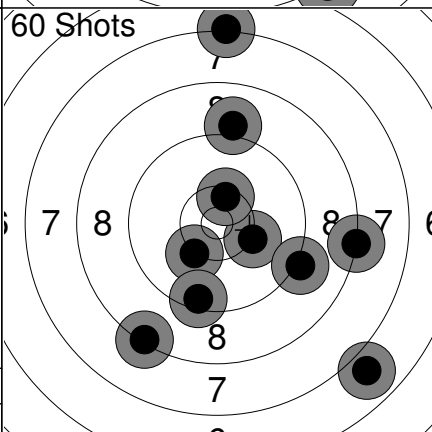

31:	9.0	↑
32:	10.2	↘
33:	6.9	↘
34:	9.4	↘
35:	7.2	↑
36:	8.3	↘
37:	8.2	→
38:	10.2	→
39:	10.4x	↑
40:	9.2	→
Series	86 (1x)	
	344 (6x)	

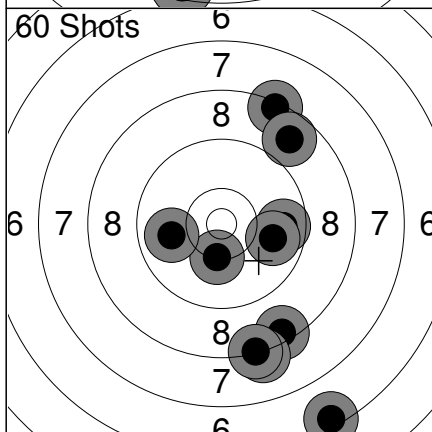

41:	6.4	↘
42:	8.4	↘
43:	8.1	↘
44:	8.3	↗
45:	8.7	↗
46:	9.7	→
47:	8.3	↘
48:	9.9	→
49:	10.3	↘
50:	9.9	←
Series	83 (0x)	
	427 (6x)	

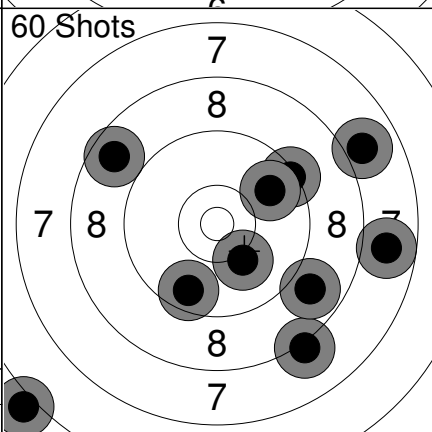

51:	6.0	↘
52:	8.1	↘
53:	8.7	↗
54:	7.9	↗
55:	10.1	↘
56:	9.6	↘
57:	9.3	↗
58:	7.8	→
59:	8.8	↘
60:	9.8	↗
Series	81 (0x)	
	508 (6x)	

Relay **2** Lane **10** **NICOL Sophia ting**

2023 AHA Memorial BC JR WP

18.11.2023 2023 Memorial Q Alberta Handgun Association

Comment Signature

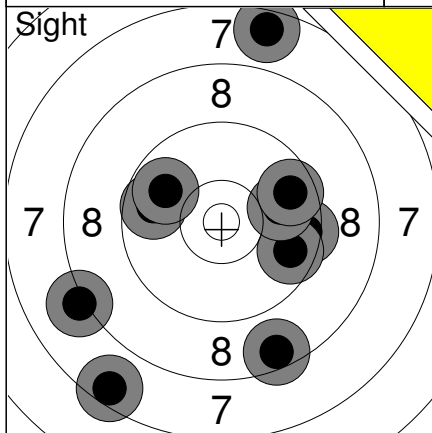

1:	8.1	↙
2:	9.5	→
3:	7.6	↑
4:	8.5	↘
5:	9.7	→
6:	9.9	→
7:	9.8	↙
8:	7.5	↘
9:	9.7	→
10:	9.9	↙
Series	84 (0x)	
	0 (0x)	

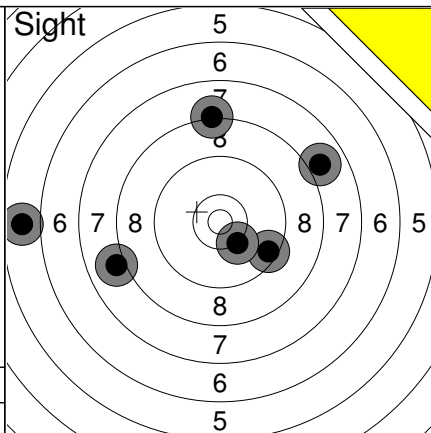

11:	7.9	↗
12:	9.5	↘
13:	10.2	↘
14:	8.0	↙
15:	5.7	↙
16:	8.2	↑
Series	47 (0x)	
	0 (0x)	

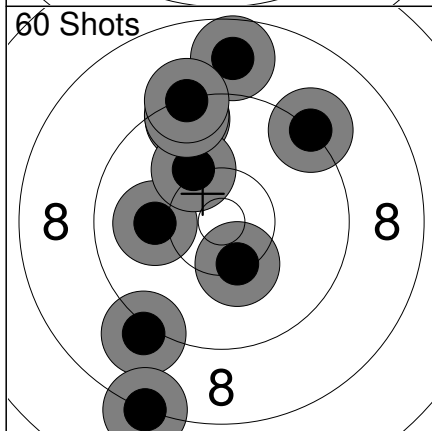

1:	10.3	↘
2:	9.5	↗
3:	10.1	↙
4:	10.2	↗
5:	9.1	↘
6:	9.4	↗
7:	8.8	↗
8:	9.3	↗
9:	9.2	↗
10:	8.2	↘
Series	91 (0x)	
	91 (0x)	

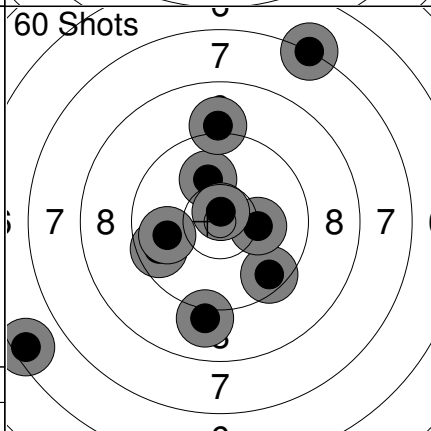

11:	7.2	↗
12:	9.5	↘
13:	6.5	↙
14:	10.1	↗
15:	9.1	↗
16:	9.0	↘
17:	9.6	↙
18:	10.2	→
19:	10.8x	↗
20:	9.9	↙
Series	88 (1x)	
	179 (1x)	

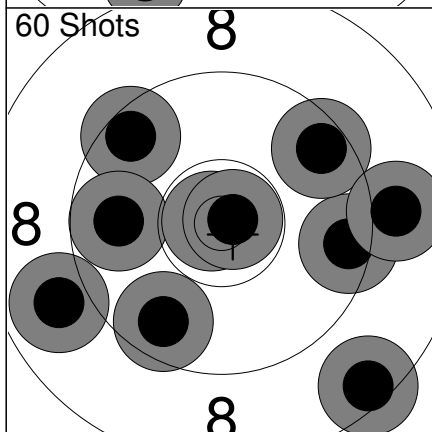

21:	9.7	↘
22:	9.5	↗
23:	9.8	↙
24:	10.8x	↙
25:	9.5	→
26:	9.5	↗
27:	8.5	↘
28:	9.0	→
29:	10.8x	→
30:	8.9	↙
Series	90 (2x)	
	269 (3x)	

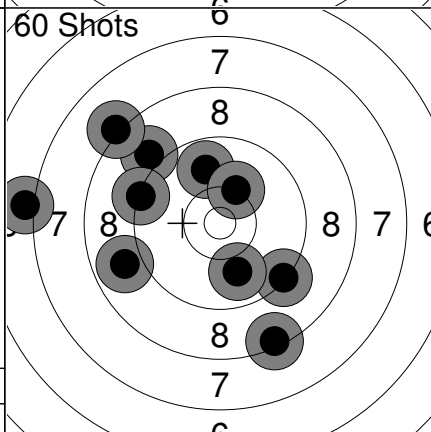

31:	8.4	↘
32:	9.3	↘
33:	9.8	↗
34:	10.2	↗
35:	7.0	↙
36:	9.0	↗
37:	8.1	↗
38:	9.9	↘
39:	9.3	↙
40:	8.9	↙
Series	86 (0x)	
	355 (3x)	

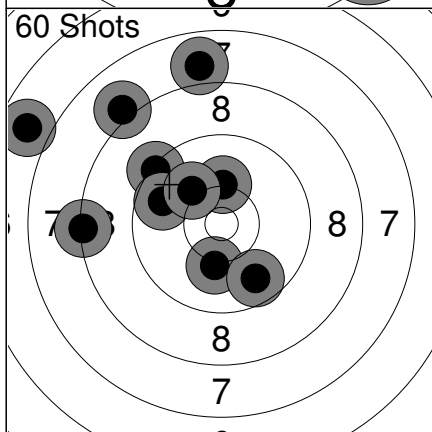

41:	10.2	↗
42:	6.8	↙
43:	10.1	↘
44:	8.3	↙
45:	7.9	↗
46:	8.1	↗
47:	9.7	↘
48:	9.3	↗
49:	9.7	↗
50:	10.1	↗
Series	86 (0x)	
	441 (3x)	

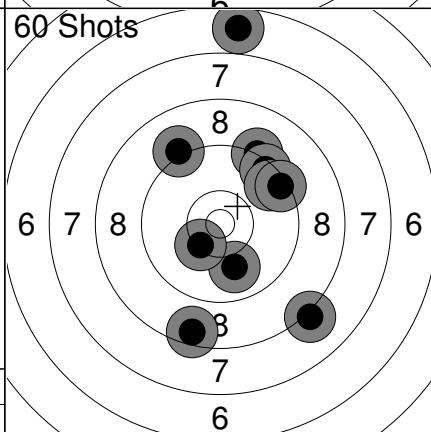

51:	10.0	↘
52:	9.2	↗
53:	8.5	↘
54:	8.1	↘
55:	9.4	↗
56:	9.1	↗
57:	9.6	↗
58:	10.3	↘
59:	9.4	↗
60:	6.7	↗
Series	87 (0x)	
	528 (3x)	

Relay 2	Lane 11	BRITTON Kim
-------------------	-------------------	--------------------

2023 AHA Memorial	AB	SR	WP
-------------------	----	----	----

18.11.2023	2023 Memorial Q	Alberta Handgun Association
------------	-----------------	-----------------------------

Comment	Signature
---------	-----------

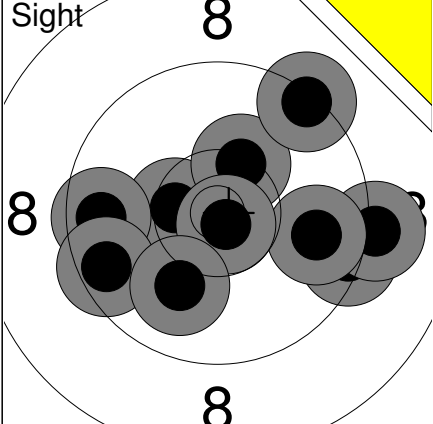
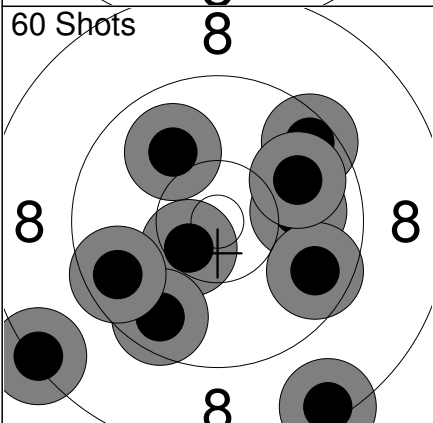
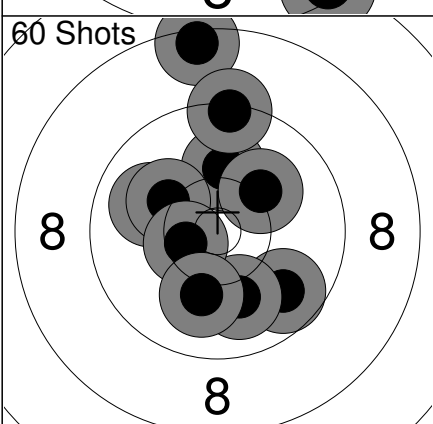
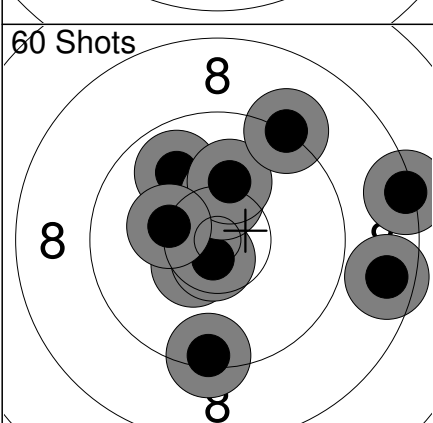
<p>Sight</p> 	<p>60 Shots</p> 	<p>60 Shots</p> 	<p>60 Shots</p> 																																																																																																																									
<table border="1" style="width:100%; border-collapse: collapse;"> <tr><td>1: 10.5x</td><td>←</td></tr> <tr><td>2: 9.4</td><td>→</td></tr> <tr><td>3: 9.6</td><td>←</td></tr> <tr><td>4: 9.1</td><td>→</td></tr> <tr><td>5: 9.8</td><td>→</td></tr> <tr><td>6: 10.3</td><td>↑</td></tr> <tr><td>7: 9.5</td><td>←</td></tr> <tr><td>8: 9.3</td><td>↑</td></tr> <tr><td>9: 10.8x</td><td>↓</td></tr> <tr><td>10: 10.0</td><td>↓</td></tr> <tr><td colspan="2">Series 94 (2x)</td></tr> <tr><td colspan="2">0 (0x)</td></tr> </table>	1: 10.5x	←	2: 9.4	→	3: 9.6	←	4: 9.1	→	5: 9.8	→	6: 10.3	↑	7: 9.5	←	8: 9.3	↑	9: 10.8x	↓	10: 10.0	↓	Series 94 (2x)		0 (0x)		<table border="1" style="width:100%; border-collapse: collapse;"> <tr><td>11: 10.5x</td><td>↙</td></tr> <tr><td>12: 8.4</td><td>↓</td></tr> <tr><td>13: 9.5</td><td>→</td></tr> <tr><td>14: 10.0</td><td>→</td></tr> <tr><td>15: 9.7</td><td>→</td></tr> <tr><td>16: 9.6</td><td>↓</td></tr> <tr><td>17: 9.6</td><td>←</td></tr> <tr><td>18: 9.9</td><td>→</td></tr> <tr><td>19: 8.3</td><td>↙</td></tr> <tr><td>20: 10.0</td><td>↑</td></tr> <tr><td colspan="2">Series 91 (1x)</td></tr> <tr><td colspan="2">186 (2x)</td></tr> </table>	11: 10.5x	↙	12: 8.4	↓	13: 9.5	→	14: 10.0	→	15: 9.7	→	16: 9.6	↓	17: 9.6	←	18: 9.9	→	19: 8.3	↙	20: 10.0	↑	Series 91 (1x)		186 (2x)		<table border="1" style="width:100%; border-collapse: collapse;"> <tr><td>21: 10.5x</td><td>↑</td></tr> <tr><td>22: 9.9</td><td>↑</td></tr> <tr><td>23: 9.2</td><td>←</td></tr> <tr><td>24: 9.9</td><td>↑</td></tr> <tr><td>25: 9.6</td><td>↖</td></tr> <tr><td>26: 8.4</td><td>→</td></tr> <tr><td>27: 9.6</td><td>↓</td></tr> <tr><td>28: 9.1</td><td>↓</td></tr> <tr><td>29: 9.5</td><td>↑</td></tr> <tr><td>30: 10.8x</td><td>↑</td></tr> <tr><td colspan="2">Series 91 (2x)</td></tr> <tr><td colspan="2">277 (4x)</td></tr> </table>	21: 10.5x	↑	22: 9.9	↑	23: 9.2	←	24: 9.9	↑	25: 9.6	↖	26: 8.4	→	27: 9.6	↓	28: 9.1	↓	29: 9.5	↑	30: 10.8x	↑	Series 91 (2x)		277 (4x)		<table border="1" style="width:100%; border-collapse: collapse;"> <tr><td>31: 9.8</td><td>↘</td></tr> <tr><td>32: 10.1</td><td>↑</td></tr> <tr><td>33: 10.0</td><td>↓</td></tr> <tr><td>34: 8.4</td><td>↑</td></tr> <tr><td>35: 10.0</td><td>←</td></tr> <tr><td>36: 10.2</td><td>↖</td></tr> <tr><td>37: 9.3</td><td>↑</td></tr> <tr><td>38: 10.5x</td><td>←</td></tr> <tr><td>39: 10.2</td><td>↗</td></tr> <tr><td>40: 10.1</td><td>↓</td></tr> <tr><td colspan="2">Series 96 (1x)</td></tr> <tr><td colspan="2">373 (5x)</td></tr> </table>	31: 9.8	↘	32: 10.1	↑	33: 10.0	↓	34: 8.4	↑	35: 10.0	←	36: 10.2	↖	37: 9.3	↑	38: 10.5x	←	39: 10.2	↗	40: 10.1	↓	Series 96 (1x)		373 (5x)		<table border="1" style="width:100%; border-collapse: collapse;"> <tr><td>41: 9.7</td><td>↘</td></tr> <tr><td>42: 10.5x</td><td>↑</td></tr> <tr><td>43: 10.1</td><td>↓</td></tr> <tr><td>44: 10.2</td><td>↑</td></tr> <tr><td>45: 10.4x</td><td>↑</td></tr> <tr><td>46: 10.3</td><td>↑</td></tr> <tr><td>47: 9.3</td><td>↓</td></tr> <tr><td>48: 10.1</td><td>↑</td></tr> <tr><td>49: 10.3</td><td>↗</td></tr> <tr><td>50: 8.8</td><td>↑</td></tr> <tr><td colspan="2">Series 96 (2x)</td></tr> <tr><td colspan="2">469 (7x)</td></tr> </table>	41: 9.7	↘	42: 10.5x	↑	43: 10.1	↓	44: 10.2	↑	45: 10.4x	↑	46: 10.3	↑	47: 9.3	↓	48: 10.1	↑	49: 10.3	↗	50: 8.8	↑	Series 96 (2x)		469 (7x)	
1: 10.5x	←																																																																																																																											
2: 9.4	→																																																																																																																											
3: 9.6	←																																																																																																																											
4: 9.1	→																																																																																																																											
5: 9.8	→																																																																																																																											
6: 10.3	↑																																																																																																																											
7: 9.5	←																																																																																																																											
8: 9.3	↑																																																																																																																											
9: 10.8x	↓																																																																																																																											
10: 10.0	↓																																																																																																																											
Series 94 (2x)																																																																																																																												
0 (0x)																																																																																																																												
11: 10.5x	↙																																																																																																																											
12: 8.4	↓																																																																																																																											
13: 9.5	→																																																																																																																											
14: 10.0	→																																																																																																																											
15: 9.7	→																																																																																																																											
16: 9.6	↓																																																																																																																											
17: 9.6	←																																																																																																																											
18: 9.9	→																																																																																																																											
19: 8.3	↙																																																																																																																											
20: 10.0	↑																																																																																																																											
Series 91 (1x)																																																																																																																												
186 (2x)																																																																																																																												
21: 10.5x	↑																																																																																																																											
22: 9.9	↑																																																																																																																											
23: 9.2	←																																																																																																																											
24: 9.9	↑																																																																																																																											
25: 9.6	↖																																																																																																																											
26: 8.4	→																																																																																																																											
27: 9.6	↓																																																																																																																											
28: 9.1	↓																																																																																																																											
29: 9.5	↑																																																																																																																											
30: 10.8x	↑																																																																																																																											
Series 91 (2x)																																																																																																																												
277 (4x)																																																																																																																												
31: 9.8	↘																																																																																																																											
32: 10.1	↑																																																																																																																											
33: 10.0	↓																																																																																																																											
34: 8.4	↑																																																																																																																											
35: 10.0	←																																																																																																																											
36: 10.2	↖																																																																																																																											
37: 9.3	↑																																																																																																																											
38: 10.5x	←																																																																																																																											
39: 10.2	↗																																																																																																																											
40: 10.1	↓																																																																																																																											
Series 96 (1x)																																																																																																																												
373 (5x)																																																																																																																												
41: 9.7	↘																																																																																																																											
42: 10.5x	↑																																																																																																																											
43: 10.1	↓																																																																																																																											
44: 10.2	↑																																																																																																																											
45: 10.4x	↑																																																																																																																											
46: 10.3	↑																																																																																																																											
47: 9.3	↓																																																																																																																											
48: 10.1	↑																																																																																																																											
49: 10.3	↗																																																																																																																											
50: 8.8	↑																																																																																																																											
Series 96 (2x)																																																																																																																												
469 (7x)																																																																																																																												
<table border="1" style="width:100%; border-collapse: collapse;"> <tr><td>51: 10.5x</td><td>↙</td></tr> <tr><td>52: 9.9</td><td>↖</td></tr> <tr><td>53: 8.3</td><td>→</td></tr> <tr><td>54: 10.7x</td><td>↓</td></tr> <tr><td>55: 10.4x</td><td>↑</td></tr> <tr><td>56: 9.4</td><td>↓</td></tr> <tr><td>57: 10.2</td><td>↑</td></tr> <tr><td>58: 8.6</td><td>→</td></tr> <tr><td>59: 9.2</td><td>↗</td></tr> <tr><td>60: 10.3</td><td>←</td></tr> <tr><td colspan="2">Series 93 (3x)</td></tr> <tr><td colspan="2">562 (10x)</td></tr> </table>	51: 10.5x	↙	52: 9.9	↖	53: 8.3	→	54: 10.7x	↓	55: 10.4x	↑	56: 9.4	↓	57: 10.2	↑	58: 8.6	→	59: 9.2	↗	60: 10.3	←	Series 93 (3x)		562 (10x)																																																																																																					
51: 10.5x	↙																																																																																																																											
52: 9.9	↖																																																																																																																											
53: 8.3	→																																																																																																																											
54: 10.7x	↓																																																																																																																											
55: 10.4x	↑																																																																																																																											
56: 9.4	↓																																																																																																																											
57: 10.2	↑																																																																																																																											
58: 8.6	→																																																																																																																											
59: 9.2	↗																																																																																																																											
60: 10.3	←																																																																																																																											
Series 93 (3x)																																																																																																																												
562 (10x)																																																																																																																												

<p>Sight</p>	<p>1: 9.5 ↗ 2: 7.9 → 3: 9.2 ↗ 4: 10.2x ↓ 5: 10.3x ↓ 6: 10.4x ↗ 7: 7.5 ↓ 8: 8.8 ↗ 9: 10.3x ↓ 10: 10.1 ↗</p> <p>Series 94.2 0.0</p>	<p>Sight</p>	<p>11: 9.4 ← 12: 8.9 ← 13: 10.5x →</p> <p>Series 28.8 0.0</p>
<p>60 Shots</p>	<p>1: 9.9 ↑ 2: 9.8 → 3: 10.2x ↓ 4: 9.4 → 5: 10.7x ↑ 6: 9.4 ↗ 7: 9.4 ↓ 8: 10.5x ↗ 9: 9.3 ← 10: 9.3 ↑</p> <p>Series 97.9 97.9</p>	<p>60 Shots</p>	<p>11: 9.0 ↗ 12: 10.3x ↑ 13: 10.0 ↗ 14: 9.0 ↗ 15: 10.2x ↓ 16: 9.2 ↗ 17: 9.7 → 18: 9.5 ← 19: 10.1 ↓ 20: 10.3x ↗</p> <p>Series 97.3 195.2</p>
<p>60 Shots</p>	<p>21: 10.4x ↑ 22: 9.3 ↑ 23: 10.3x ↓ 24: 10.7x ↑ 25: 10.2x ↓ 26: 9.5 ↗ 27: 10.4x ↑ 28: 8.9 ← 29: 10.0 ↗ 30: 9.2 ↗</p> <p>Series 98.9 294.1</p>	<p>60 Shots</p>	<p>31: 8.8 ↑ 32: 10.7x ↓ 33: 9.9 ← 34: 10.0 ← 35: 10.1 ↓ 36: 10.7x → 37: 10.3x ↑ 38: 10.0 ← 39: 10.0 ↓ 40: 10.2x →</p> <p>Series 100.7 394.8</p>
<p>60 Shots</p>	<p>41: 10.0 ↗ 42: 10.3x ← 43: 10.2x ↗ 44: 9.2 ↗ 45: 9.8 ↗ 46: 10.6x ↓ 47: 8.9 ← 48: 9.2 ↗ 49: 9.1 ↗ 50: 9.9 ↑</p> <p>Series 97.2 492.0</p>	<p>60 Shots</p>	<p>51: 9.3 ↑ 52: 8.7 → 53: 9.6 → 54: 10.6x ← 55: 9.7 ↗ 56: 9.7 ↗ 57: 9.7 ↑ 58: 10.1 ← 59: 8.8 ← 60: 10.2x →</p> <p>Series 96.4 588.4</p>

Relay 3	Lane 2	DU Max	
2023 AHA Memorial		AB	JR MP
18.11.2023		2023 Memorial Q	Alberta Handgun Association
Comment		Signature	

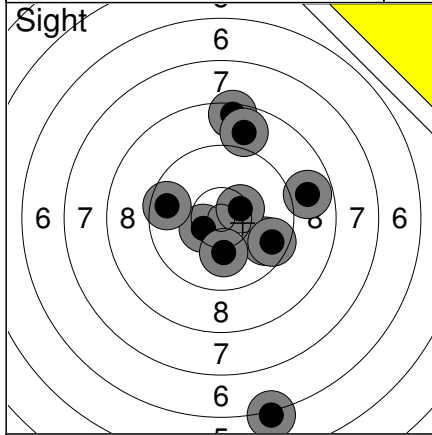

1:	10.4x	↙
2:	9.8	↘
3:	9.6	↖
4:	8.5	↗
5:	6.2	↘
6:	10.5x	→
7:	10.1	↘
8:	8.8	→
9:	9.6	↘
10:	8.9	↑
Series	87 (2x)	
	0 (0x)	

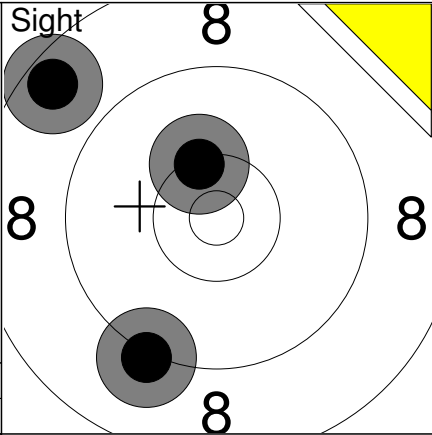

11:	10.3	↗
12:	8.5	↗
13:	9.2	↘
Series	27 (0x)	
	0 (0x)	

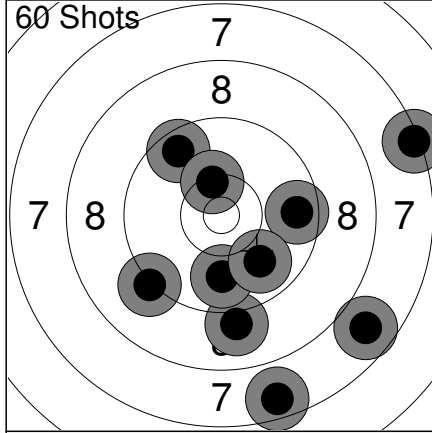

1:	9.6	↗
2:	10.3	↗
3:	9.0	↘
4:	9.6	→
5:	9.9	↘
6:	7.6	↘
7:	7.3	→
8:	9.9	↘
9:	9.2	↖
10:	7.7	↘
Series	85 (0x)	
	85 (0x)	

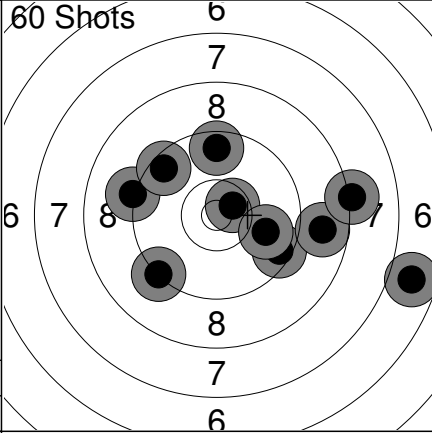

11:	9.6	↑
12:	9.2	↖
13:	9.5	↗
14:	6.8	→
15:	10.6x	↗
16:	9.5	↘
17:	8.8	→
18:	9.3	↖
19:	8.2	→
20:	9.9	→
Series	86 (1x)	
	171 (1x)	

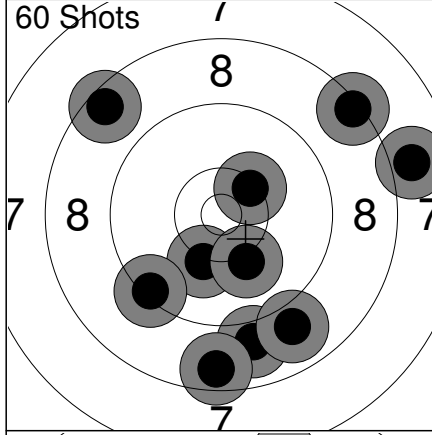

21:	8.9	↘
22:	7.9	→
23:	8.6	↘
24:	8.5	↗
25:	10.2	↘
26:	8.9	↘
27:	8.3	→
28:	10.1	↘
29:	9.3	↖
30:	10.3	↗
Series	86 (0x)	
	257 (1x)	

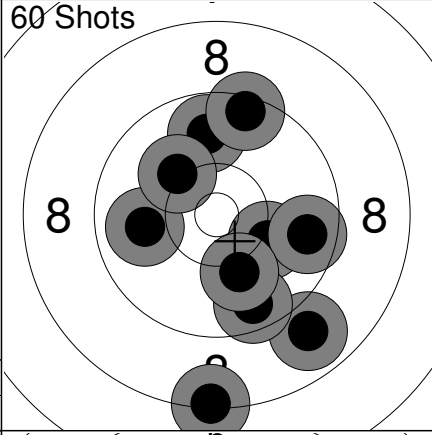

31:	8.3	↘
32:	8.9	↘
33:	10.2	↘
34:	9.8	↑
35:	9.6	↘
36:	9.9	↖
37:	9.6	→
38:	10.1	↘
39:	9.4	↑
40:	10.2	↗
Series	91 (0x)	
	348 (1x)	

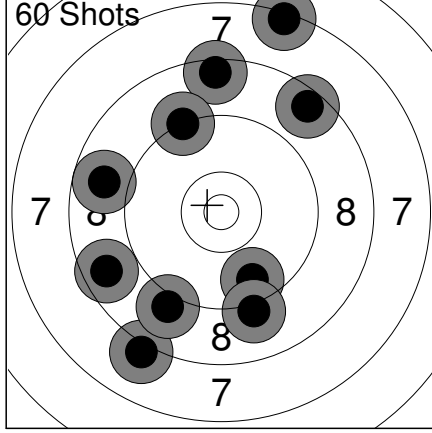

41:	8.7	↖
42:	8.5	↑
43:	8.1	↘
44:	7.3	↑
45:	9.2	↑
46:	8.5	↗
47:	9.0	↖
48:	8.8	↖
49:	9.6	↘
50:	9.1	↘
Series	83 (0x)	
	431 (1x)	

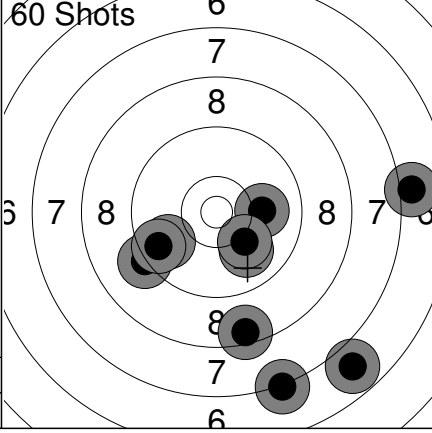

51:	10.0	→
52:	9.8	↖
53:	9.2	↖
54:	7.2	↘
55:	8.5	↘
56:	7.0	→
57:	10.0	↘
58:	10.1	↘
59:	9.6	↖
60:	6.8	↘
Series	85 (0x)	
	516 (1x)	

Relay **3** Lane **3** **NORMAN Rex**

2023 AHA Memorial SK JR MP

18.11.2023 2023 Memorial Q Alberta Handgun Association

Comment Signature

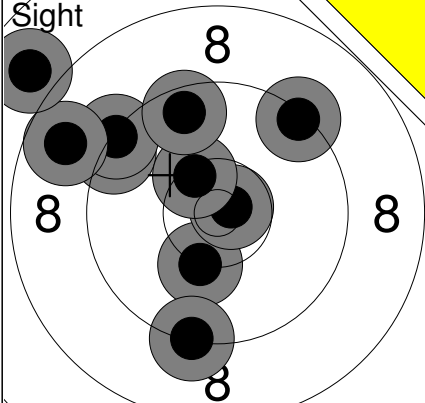
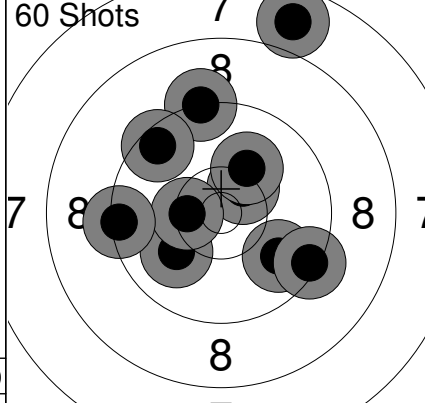
	1: 9.4 ↖		1: 7.8 ↗
	2: 9.3 ↗		2: 10.0 ↘
	3: 10.2 ↘		3: 10.4x ↗
	4: 8.8 ↖		4: 10.2 ↗
	5: 7.9 ↗		5: 10.4x ←
	6: 9.3 ↘		6: 9.8 ↘
	7: 10.8x →		7: 9.4 ←
	8: 9.3 ↗		8: 9.2 ↗
	9: 10.4x ↗		9: 9.4 ↘
	10: 9.6 ↗		10: 9.5 ↖
	Series 90 (2x)		Series 92 (2x)
	0 (0x)		92 (2x)

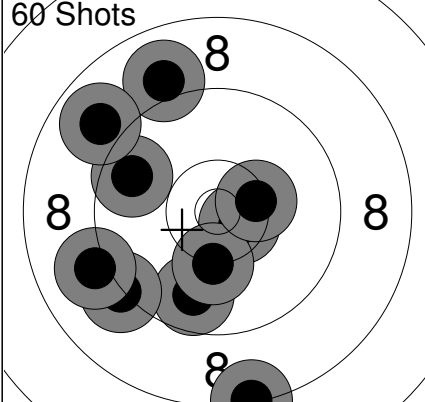
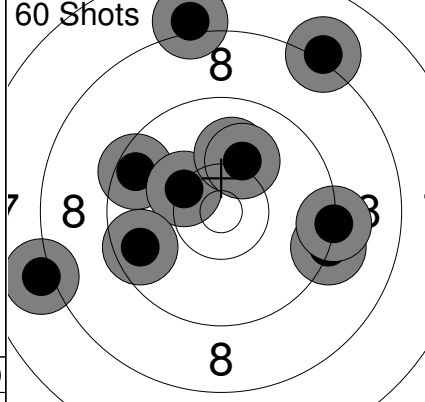
	11: 9.0 ↗		21: 8.1 ←
	12: 10.6x ↘		22: 9.5 ↖
	13: 9.7 ↘		23: 8.1 ↗
	14: 9.2 ←		24: 10.3 ↖
	15: 9.1 ←		25: 10.1 ↗
	16: 9.7 ↗		26: 8.1 ↗
	17: 8.9 ↗		27: 9.6 ←
	18: 10.2 ↘		28: 9.3 →
	19: 8.3 ↘		29: 10.1 ↗
	20: 10.4x →		30: 9.3 →
	Series 91 (2x)		Series 90 (0x)
	183 (4x)		273 (4x)

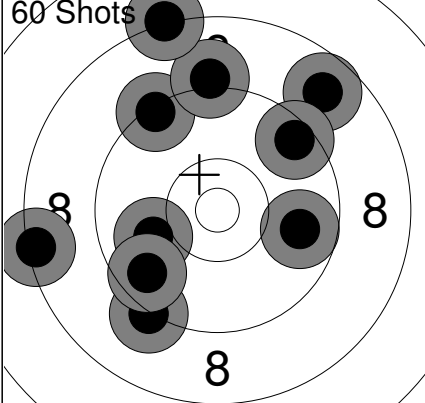
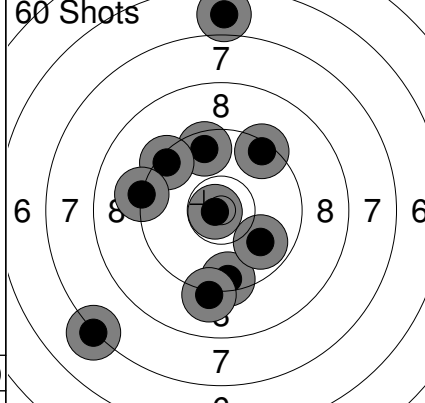
	31: 8.7 ↗		41: 9.5 ↓
	32: 9.2 ↘		42: 9.6 ↗
	33: 10.0 ←		43: 9.4 ↗
	34: 9.8 →		44: 9.4 ↗
	35: 9.3 ↗		45: 9.2 ←
	36: 9.6 ↖		46: 9.9 ↘
	37: 8.4 ←		47: 6.8 ↗
	38: 9.5 ↗		48: 9.1 ↓
	39: 9.1 ↗		49: 7.2 ↘
	40: 8.2 ↗		50: 10.8x ←
	Series 88 (0x)		Series 86 (1x)
	361 (4x)		447 (5x)

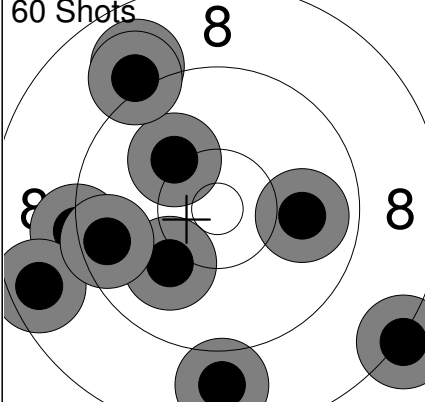
	51: 9.2 ←	
	52: 8.2 ↘	
	53: 10.2 ↗	
	54: 10.1 ↘	
	55: 8.8 ↘	
	56: 9.9 →	
	57: 8.6 ←	
	58: 9.0 ↗	
	59: 9.1 ↗	
	60: 9.6 ←	
	Series 89 (0x)	
	536 (5x)	

Relay **3** Lane **4** **NORMAN Seth**

2023 AHA Memorial SK JR MP

18.11.2023 2023 Memorial Q Alberta Handgun Association

Comment Signature

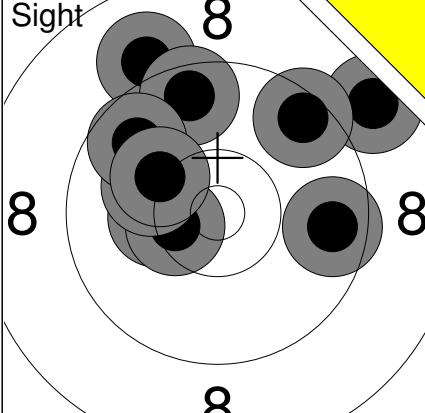
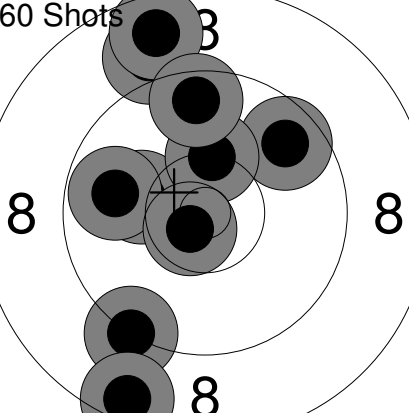
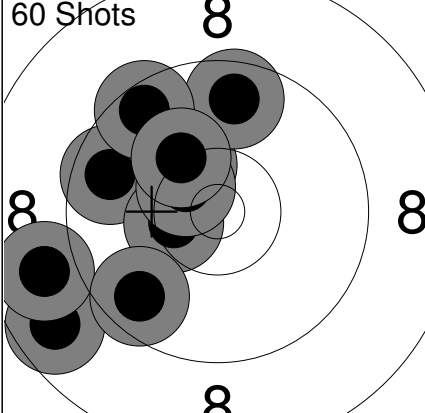
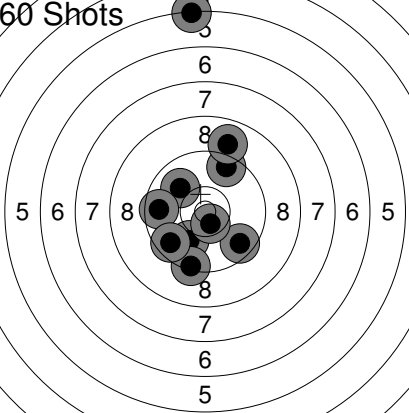
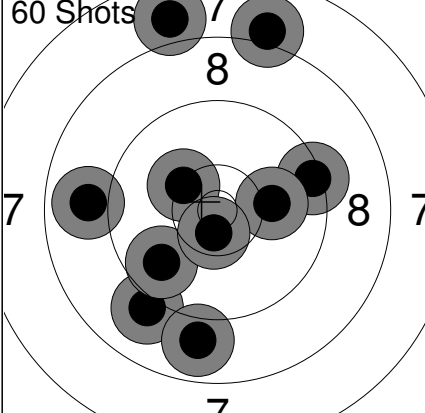
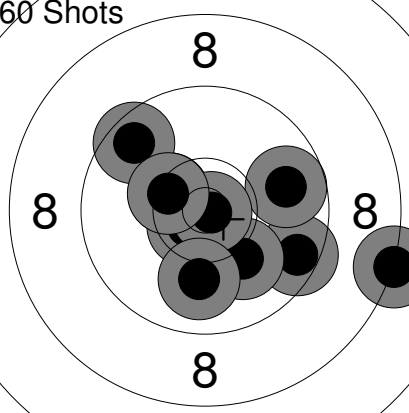
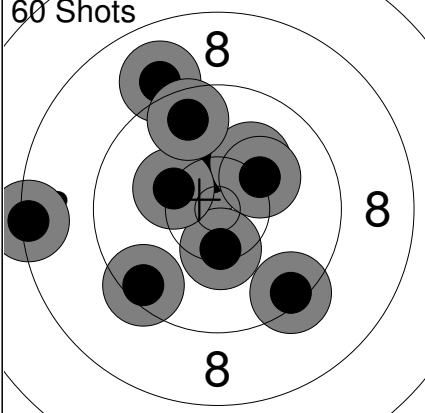
<p>Sight</p> 	<p>1: 8.8 ↗ 2: 10.3 ← 3: 9.5 ↗ 4: 9.6 → 5: 9.0 ↗ 6: 10.4x ← 7: 9.6 ↗ 8: 10.1 ← 9: 9.7 ↗ 10: 10.2 ↗</p> <p>Series 93 (1x) 0 (0x)</p>	<p>60 Shots</p> 	<p>1: 10.2 ← 2: 9.7 ↗ 3: 9.2 ↓ 4: 8.5 ↓ 5: 9.8 ← 6: 8.9 ↑ 7: 8.7 ↑ 8: 10.3 ↑ 9: 9.6 ↑ 10: 10.7x ↓</p> <p>Series 90 (1x) 90 (1x)</p>
<p>60 Shots</p> 	<p>11: 8.7 ← 12: 10.3 ↗ 13: 9.7 ↗ 14: 10.4x ← 15: 10.5x ↗ 16: 8.9 ← 17: 9.6 ↓ 18: 9.7 ↑ 19: 9.5 ↗ 20: 10.2 ↗</p> <p>Series 92 (2x) 182 (3x)</p>	<p>60 Shots</p> 	<p>21: 9.6 ↘ 22: 10.0 ↓ 23: 9.5 ↑ 24: 10.6x ↓ 25: 10.0 ↗ 26: 9.6 ← 27: 8.9 ↑ 28: 9.3 ↓ 29: 9.6 ↘ 30: 5.2 ↑</p> <p>Series 88 (1x) 270 (4x)</p>
<p>60 Shots</p> 	<p>31: 7.9 ↑ 32: 9.1 ↓ 33: 8.0 ↑ 34: 10.3 ↗ 35: 8.9 ↓ 36: 9.4 → 37: 10.1 → 38: 9.7 ← 39: 8.9 ← 40: 10.6x ↓</p> <p>Series 88 (1x) 358 (5x)</p>	<p>60 Shots</p> 	<p>41: 10.4x ← 42: 9.5 → 43: 9.8 → 44: 10.6x ← 45: 8.2 → 46: 10.1 ↓ 47: 9.6 ↗ 48: 10.9x → 49: 10.0 ↓ 50: 10.4x ←</p> <p>Series 95 (4x) 453 (9x)</p>
<p>60 Shots</p> 	<p>51: 10.4x ↑ 52: 9.4 ↓ 53: 9.0 ↗ 54: 10.4x ↓ 55: 10.2 ↗ 56: 9.5 ← 57: 8.3 ← 58: 10.3 ← 59: 9.6 ↑ 60: 10.2 ↗</p> <p>Series 94 (2x) 547 (11x)</p>		

Relay 3	Lane 5	OZER Tugrul
-------------------	------------------	--------------------

2023 AHA Memorial	AB	SR	MP
-------------------	----	----	----

18.11.2023	2023 Memorial Q	Alberta Handgun Association
------------	-----------------	-----------------------------

Comment	Signature
---------	-----------

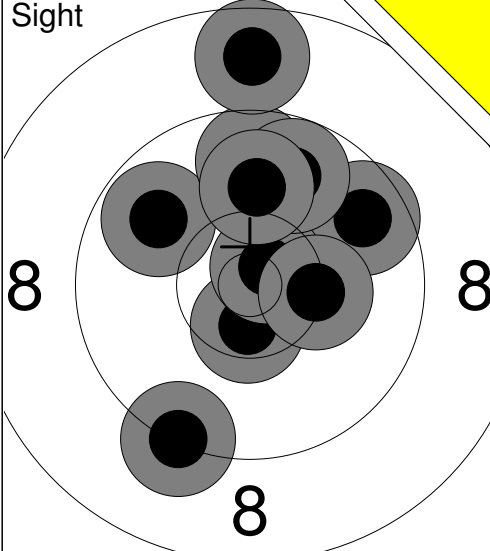
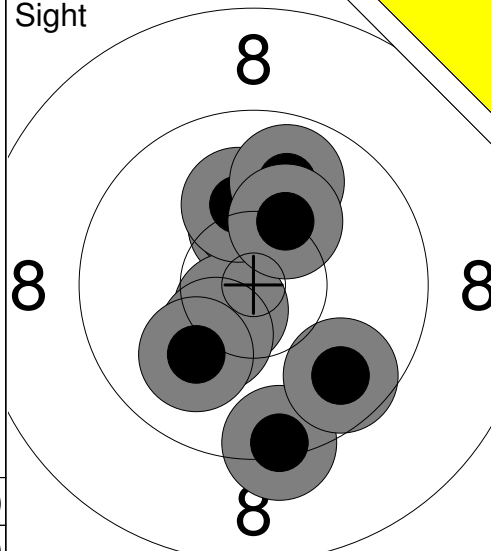
<p>Sight</p> 	<p>1: 9.7 ↗ 2: 10.5x ↓ 3: 9.8 ↖ 4: 10.7x ↗ 5: 9.7 ↑ 6: 8.7 ↑ 7: 9.8 ↑ 8: 10.3 → 9: 9.3 ↓ 10: 10.0 ↑</p> <p>Series 93 (2x) 0 (0x)</p>	<p>Sight</p> 	<p>11: 10.4x ↑ 12: 10.3 ↑ 13: 10.6x ↙ 14: 10.3 ↙ 15: 10.1 ↑ 16: 10.1 ↙ 17: 9.4 ↓ 18: 9.7 ↘ 19: 9.9 ↑ 20: 10.3 ↗</p> <p>Series 97 (2x) 0 (0x)</p>
---	--	---	--

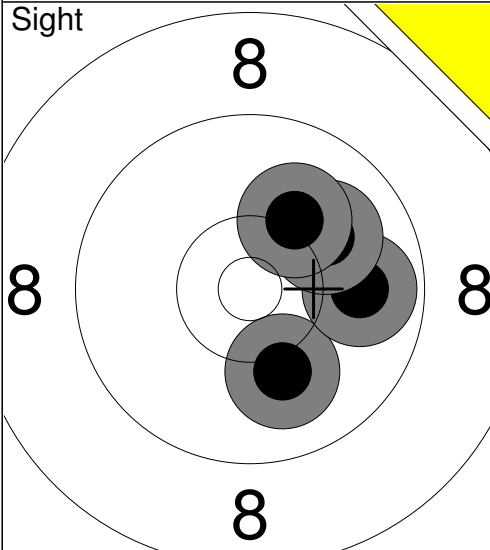
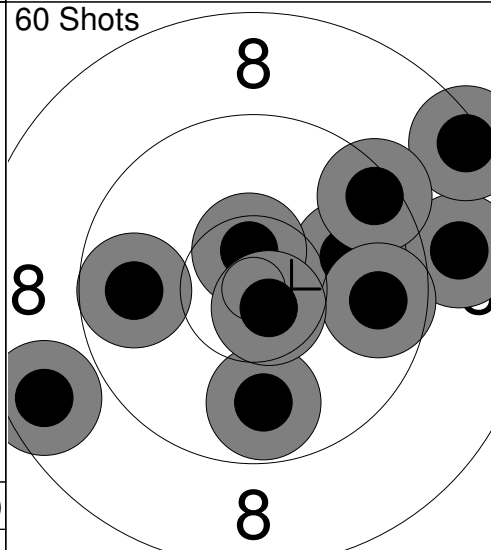
<p>Sight</p> 	<p>21: 10.1 ↓ 22: 9.9 → 23: 10.1 ↗ 24: 10.1 ↗</p> <p>Series 39 (0x) 0 (0x)</p>	<p>60 Shots</p> 	<p>1: 8.9 → 2: 9.8 ↓ 3: 10.0 → 4: 8.4 ↗ 5: 8.6 ← 6: 10.6x ↑ 7: 9.5 ↗ 8: 9.7 → 9: 9.8 ← 10: 10.7x ↘</p> <p>Series 90 (2x) 90 (2x)</p>
--	--	---	--

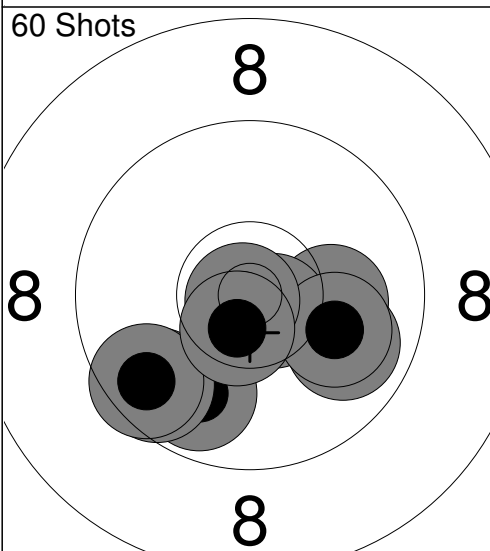
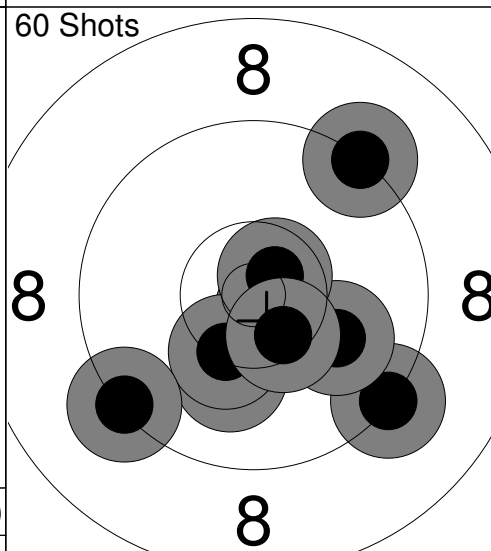
<p>60 Shots</p> 	<p>11: 9.9 ↓ 12: 10.2 → 13: 9.9 ↘ 14: 10.7x ↘ 15: 9.7 ↙ 16: 9.6 ↙ 17: 10.8x ↘ 18: 10.0 → 19: 10.9x ↙ 20: 10.6x ↓</p> <p>Series 96 (4x) 186 (6x)</p>	<p>60 Shots</p> 	<p>21: 10.7x ↘ 22: 10.6x ↘ 23: 9.3 ↘ 24: 10.1 ↓ 25: 10.3 ↓ 26: 9.3 ↙ 27: 10.0 ↘ 28: 10.7x ↗ 29: 9.3 ↗ 30: 10.5x ↘</p> <p>Series 97 (4x) 283 (10x)</p>
--	---	--	---

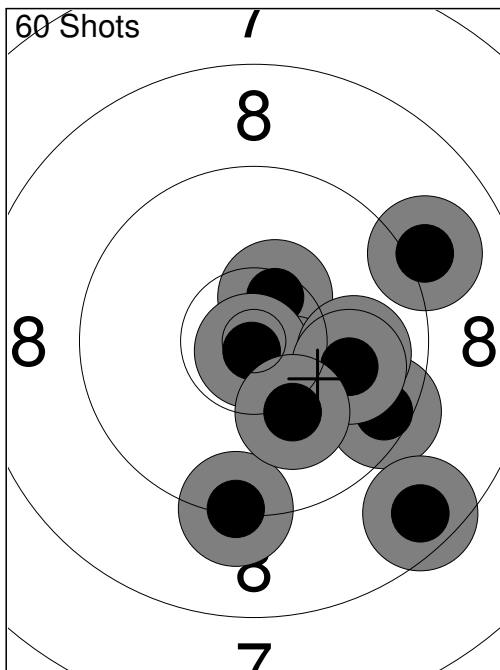

31:	9.5	↘
32:	9.3	↓
33:	10.5x	↗
34:	10.5x	↘
35:	10.8x	↓
36:	9.1	↗
37:	10.0	→
38:	10.0	→
39:	8.6	↘
40:	10.2	↘
Series		95 (3x)
		378 (13x)

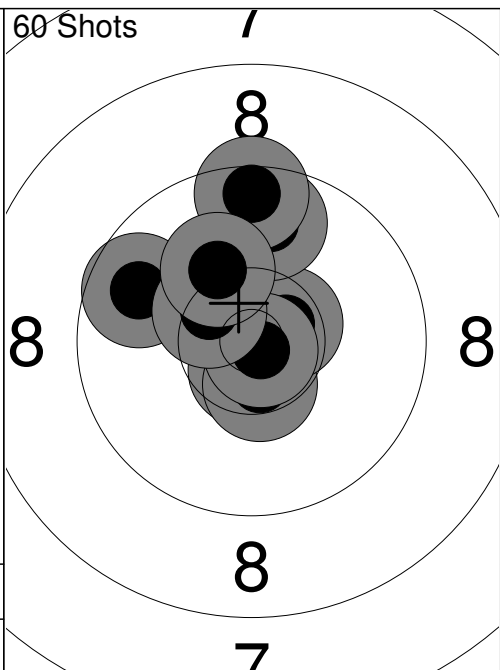

41:	10.7x	↓
42:	10.5x	↓
43:	10.3	↑
44:	10.6x	↗
45:	9.8	↑
46:	10.8x	↘
47:	9.5	↑
48:	9.7	↖
49:	10.4x	↖
50:	10.2	↗
Series		97 (5x)
		475 (18x)

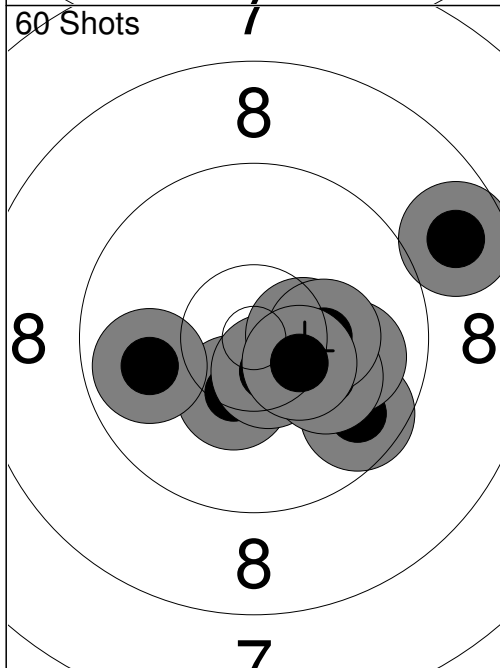

51:	10.4x	↓
52:	9.7	↘
53:	10.0	→
54:	10.6x	↓
55:	8.7	↗
56:	10.1	↘
57:	10.5x	→
58:	9.9	←
59:	10.3	→
60:	10.4x	↘
Series		96 (4x)
		571 (22x)

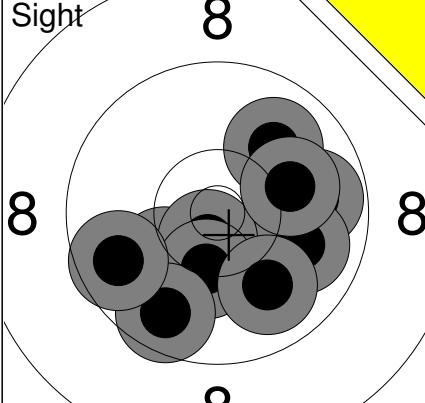
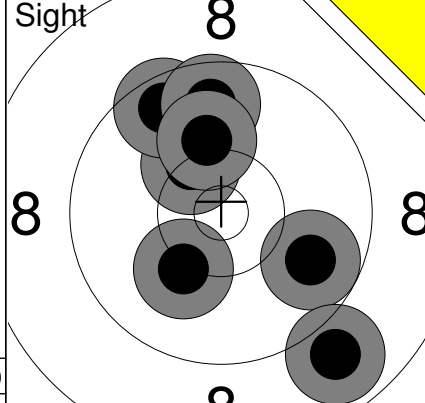
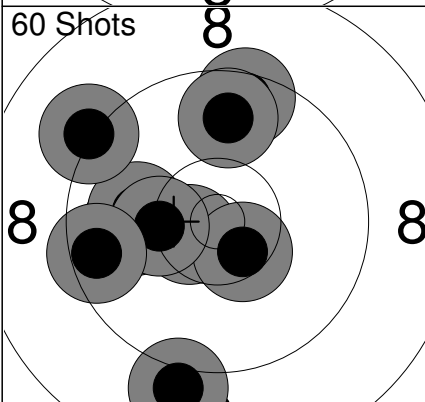
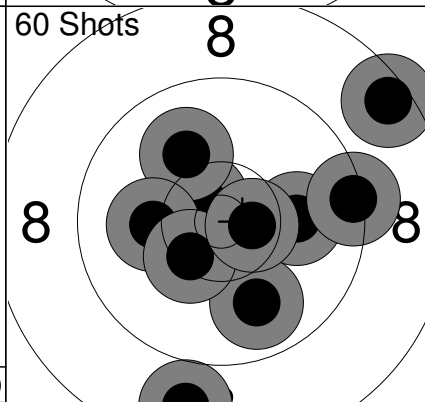
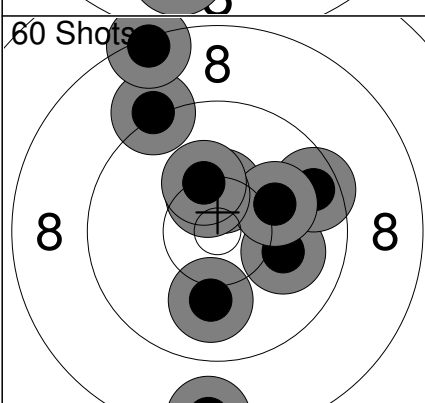
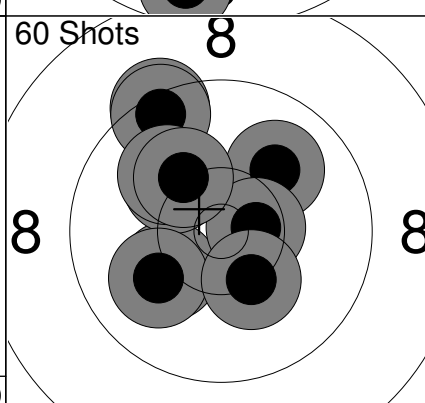
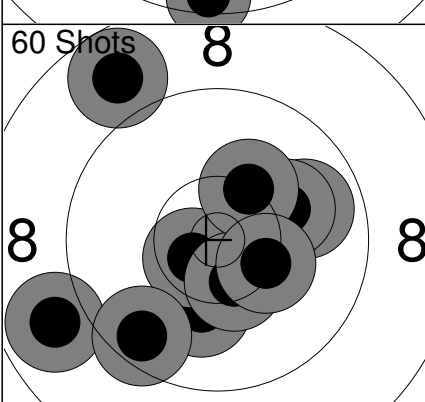
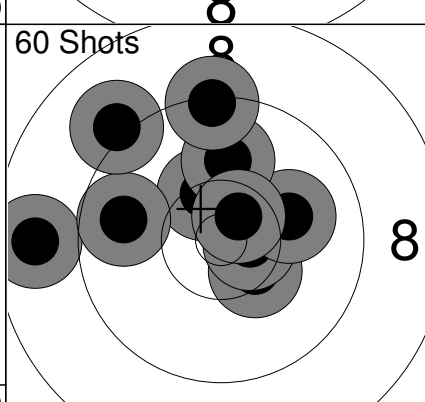
<p>Sight</p> 	<p>1: 10.2 ↙ 2: 9.8 → 3: 9.9 → 4: 10.6x ↓ 5: 10.3 ↓ 6: 10.0 ↓ 7: 10.0 ↗ 8: 9.7 ↓ 9: 9.7 ↙ 10: 10.1 →</p> <p>Series 96 (1x) 0 (0x)</p>	<p>Sight</p> 	<p>11: 10.3 ↗ 12: 9.8 ↘ 13: 8.9 ↘ 14: 9.6 ↗ 15: 9.7 ↗ 16: 10.1 ↗ 17: 10.2 ↘</p> <p>Series 65 (0x) 0 (0x)</p>
<p>60 Shots</p> 	<p>1: 9.0 ↓ 2: 10.0 ← 3: 10.6x ← 4: 10.5x ↓ 5: 10.0 ← 6: 10.3 ← 7: 9.5 ↑ 8: 9.5 ← 9: 9.8 ↑ 10: 9.2 ↖</p> <p>Series 95 (2x) 95 (2x)</p>	<p>60 Shots</p> 	<p>11: 8.7 ↓ 12: 10.6x ↗ 13: 10.0 ↗ 14: 10.0 → 15: 9.3 → 16: 10.1 ← 17: 8.5 ↗ 18: 9.9 ↓ 19: 10.4x ↙ 20: 10.6x →</p> <p>Series 94 (3x) 189 (5x)</p>
<p>60 Shots</p> 	<p>21: 9.2 ↗ 22: 10.0 ↓ 23: 8.3 ↗ 24: 10.4x ↑ 25: 10.0 → 26: 8.5 ↓ 27: 9.6 → 28: 10.1 → 29: 10.4x ↗ 30: 10.3 ↗</p> <p>Series 94 (2x) 283 (7x)</p>	<p>60 Shots</p> 	<p>31: 9.4 ↗ 32: 10.2 ↙ 33: 9.4 ↗ 34: 10.2 ↗ 35: 10.1 ↗ 36: 10.1 ↙ 37: 10.0 ↗ 38: 10.6x → 39: 10.3 ↘ 40: 10.2 ↗</p> <p>Series 98 (1x) 381 (8x)</p>
<p>60 Shots</p> 	<p>41: 10.2 ↓ 42: 9.9 → 43: 10.6x ↙ 44: 10.1 → 45: 8.8 ↗ 46: 8.9 ↙ 47: 10.4x ↓ 48: 10.3 ↗ 49: 9.6 ↙ 50: 10.3 ↘</p> <p>Series 94 (2x) 475 (10x)</p>	<p>60 Shots</p> 	<p>51: 8.7 ← 52: 10.4x ↘ 53: 10.4x ↗ 54: 9.7 ← 55: 10.6x → 56: 10.1 → 57: 9.1 ↗ 58: 10.0 ↑ 59: 9.3 ↑ 60: 10.6x ↗</p> <p>Series 95 (4x) 570 (14x)</p>

Comment	Signature
---------	-----------

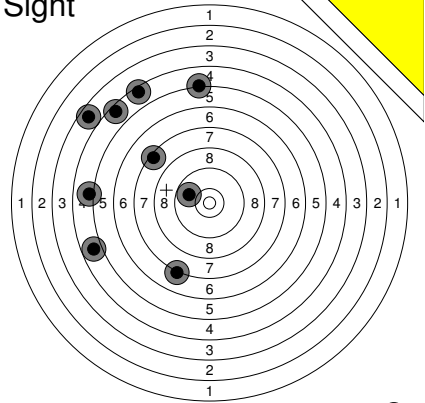
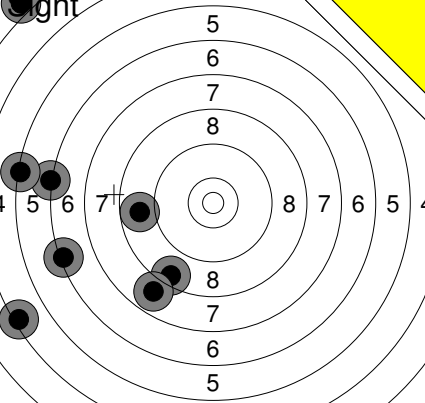
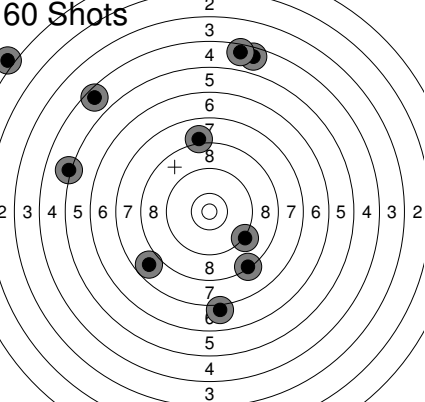
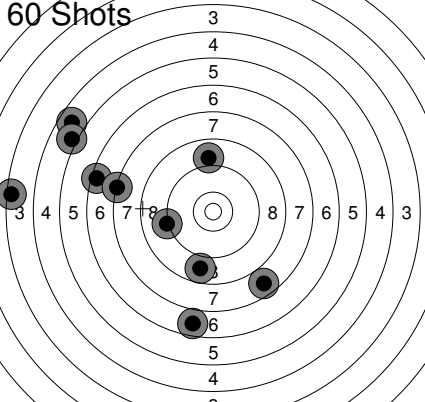
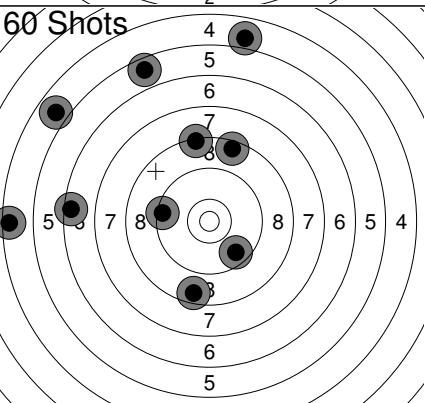
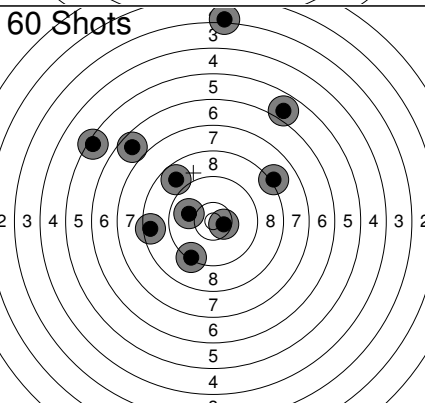
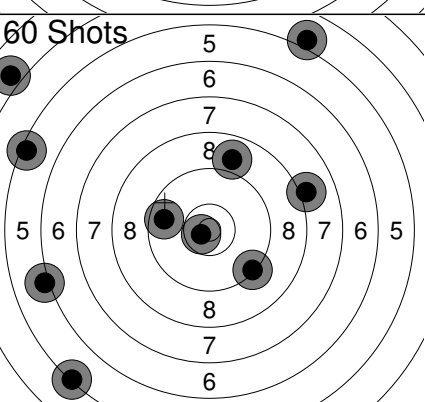
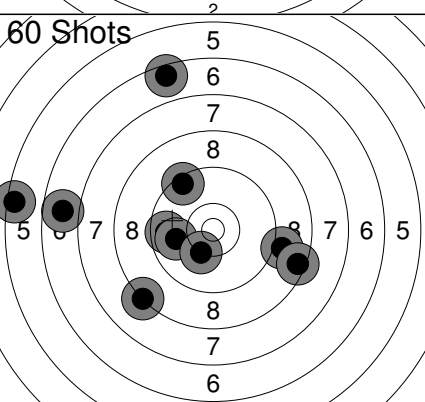
<p>Sight</p> 	<p>1: 0.0 ↘</p> <p>2: 5.0 ←</p> <p>3: 3.7 ↗</p> <p>4: 4.5 ↗</p> <p>5: 9.9 ↗</p> <p>6: 5.2 ↗</p> <p>7: 4.8 ←</p> <p>8: 4.5 ↗</p> <p>9: 7.2 ↓</p> <p>10: 7.4 ↗</p> <hr/> <p>Series 48 (0x)</p> <p style="text-align: right;">0 (0x)</p>	<p>Sight</p> 	<p>11: 6.2 ←</p> <p>12: 8.8 ←</p> <p>13: 2.9 ↗</p> <p>14: 5.3 ←</p> <p>15: 6.3 ←</p> <p>16: 8.5 ↓</p> <p>17: 3.9 ↗</p> <p>18: 4.4 ←</p> <p>19: 7.9 ↓</p> <hr/> <p>Series 49 (0x)</p> <p style="text-align: right;">0 (0x)</p>
<p>60 Shots</p> 	<p>1: 1.0 ↗</p> <p>2: 9.2 ↓</p> <p>3: 8.3 ↓</p> <p>4: 7.8 ←</p> <p>5: 7.0 ↓</p> <p>6: 4.5 ↗</p> <p>7: 5.1 ←</p> <p>8: 4.6 ↑</p> <p>9: 4.5 ↑</p> <p>10: 8.0 ↑</p> <hr/> <p>Series 57 (0x)</p> <p style="text-align: right;">57 (0x)</p>	<p>60 Shots</p> 	<p>11: 3.4 ←</p> <p>12: 8.8 ↓</p> <p>13: 7.7 ↓</p> <p>14: 4.7 ↗</p> <p>15: 5.0 ↗</p> <p>16: 9.0 ↑</p> <p>17: 9.2 ←</p> <p>18: 6.4 ←</p> <p>19: 7.3 ←</p> <p>20: 6.7 ↓</p> <hr/> <p>Series 64 (0x)</p> <p style="text-align: right;">121 (0x)</p>
<p>60 Shots</p> 	<p>21: 4.8 ←</p> <p>22: 6.4 ←</p> <p>23: 8.5 ↑</p> <p>24: 8.3 ↑</p> <p>25: 9.6 ↓</p> <p>26: 4.9 ↑</p> <p>27: 9.4 ←</p> <p>28: 5.6 ↗</p> <p>29: 4.5 ←</p> <p>30: 8.6 ↓</p> <hr/> <p>Series 65 (0x)</p> <p style="text-align: right;">186 (0x)</p>	<p>60 Shots</p> 	<p>31: 5.4 ↗</p> <p>32: 10.0 ←</p> <p>33: 5.9 ↗</p> <p>34: 10.5x →</p> <p>35: 8.1 ↗</p> <p>36: 8.8 ↗</p> <p>37: 9.3 ↓</p> <p>38: 3.1 ↑</p> <p>39: 8.5 ←</p> <p>40: 6.7 ↗</p> <hr/> <p>Series 72 (1x)</p> <p style="text-align: right;">258 (1x)</p>
<p>60 Shots</p> 	<p>41: 5.3 ↘</p> <p>42: 10.7x ←</p> <p>43: 8.0 →</p> <p>44: 5.0 ↗</p> <p>45: 6.1 ←</p> <p>46: 5.4 ↗</p> <p>47: 9.7 ←</p> <p>48: 8.9 ↑</p> <p>49: 9.3 ↓</p> <p>50: 3.9 ↗</p> <hr/> <p>Series 68 (1x)</p> <p style="text-align: right;">326 (2x)</p>	<p>60 Shots</p> 	<p>51: 5.4 ←</p> <p>52: 6.8 ←</p> <p>53: 9.7 ←</p> <p>54: 9.4 ↗</p> <p>55: 9.9 ←</p> <p>56: 10.2 ↓</p> <p>57: 6.5 ↑</p> <p>58: 9.0 →</p> <p>59: 8.2 ↘</p> <p>60: 8.4 →</p> <hr/> <p>Series 79 (0x)</p> <p style="text-align: right;">405 (2x)</p>

Relay **3** Lane **8** **NELSON Makayla**

2023 AHA Memorial SK JR WP

18.11.2023 2023 Memorial Q Alberta Handgun Association

Comment Signature

Sight 	1: 8.3 ↓	Sight 	11: 10.0 ↓
	2: 8.3 ↓		Series 10 (0x)
	3: 10.2 ↓		0 (0x)
	4: 9.3 ↓		
	5: 8.2 →		
	6: 9.6 ↖		
	7: 8.8 ↗		
	8: 6.8 ↓		
	9: 9.2 ↖		
	10: 7.7 ↓		
	Series 82 (0x)		
	0 (0x)		

60 Shots 	1: 9.0 ←	60 Shots 	11: 8.5 ↓
	2: 8.3 ↓		12: 9.4 ←
	3: 8.6 ↗		13: 10.2 ↓
	4: 6.6 ↖		14: 10.6x →
	5: 8.6 ↖		15: 10.1 ↓
	6: 8.9 ↗		16: 8.2 ↗
	7: 7.8 ↓		17: 7.2 →
	8: 9.9 ↓		18: 8.7 ↗
	9: 7.5 ←		19: 9.5 ↓
	10: 9.8 ↓		20: 9.1 ↘
	Series 79 (0x)		Series 88 (1x)
	79 (0x)		167 (1x)

60 Shots 	21: 9.1 ↑	60 Shots 	31: 10.6x →
	22: 9.3 ↓		32: 9.5 ↗
	23: 7.9 ↗		33: 10.1 ↗
	24: 9.8 ↗		34: 10.2 ←
	25: 9.5 ↓		35: 7.2 ↖
	26: 8.5 ↓		36: 9.6 ↗
	27: 8.4 ↓		37: 9.9 ↗
	28: 9.0 ↗		38: 10.0 ↗
	29: 9.3 ↓		39: 8.9 ↗
	30: 9.2 ←		40: 10.2 ↓
	Series 86 (0x)		Series 92 (1x)
	253 (1x)		345 (2x)

60 Shots 	41: 8.7 ↓	60 Shots 	51: 9.6 →
	42: 8.7 ↓		52: 9.7 ↑
	43: 7.9 ↓		53: 9.7 ↑
	44: 8.6 ↖		54: 6.0 ↗
	45: 8.8 ↖		55: 9.4 ←
	46: 9.0 ↗		56: 9.0 ←
	47: 8.1 ↓		57: 8.5 ↗
	48: 10.4x ↖		58: 9.5 ↗
	49: 10.7x ↓		59: 9.4 →
	50: 8.0 ↓		60: 9.6 ↑
	Series 84 (2x)		Series 86 (0x)
	429 (4x)		515 (4x)

Relay **3** Lane **9** **KIEJKO Lynda**

2023 AHA Memorial AB SR WP

18.11.2023 2023 Memorial Q Alberta Handgun Association

Comment Signature

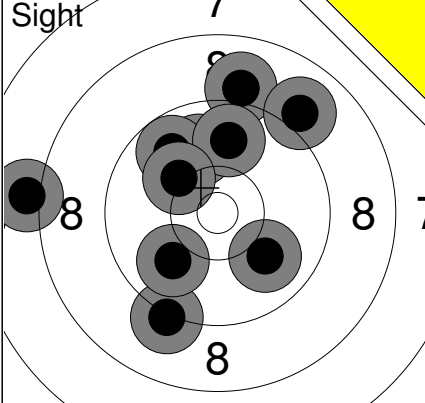
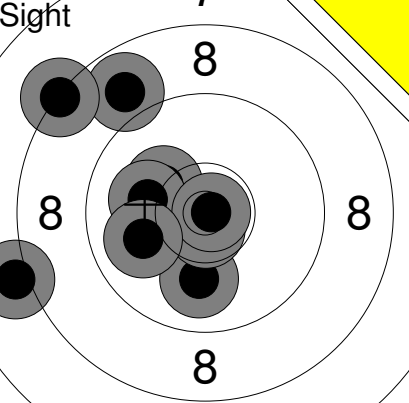
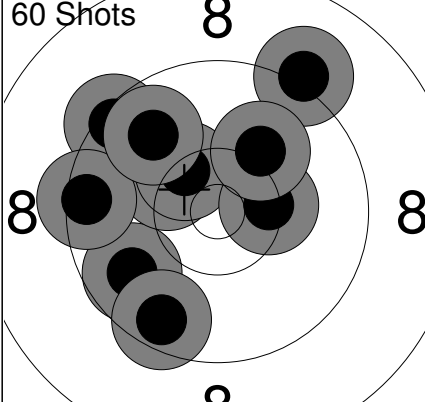
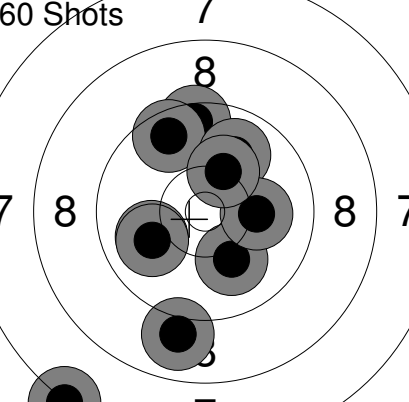
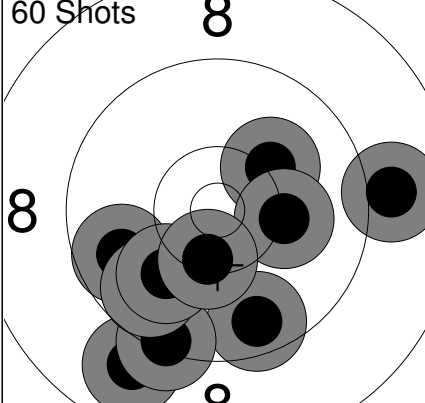
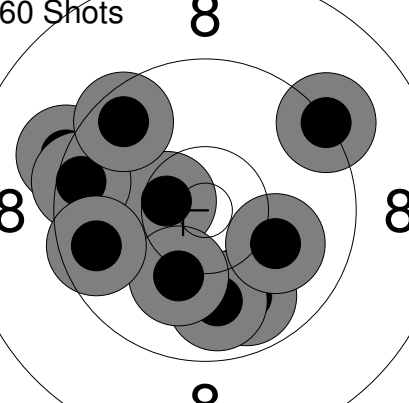
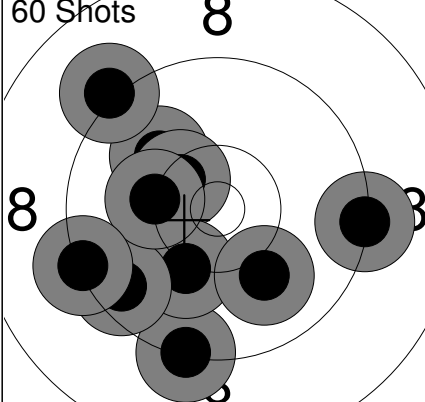
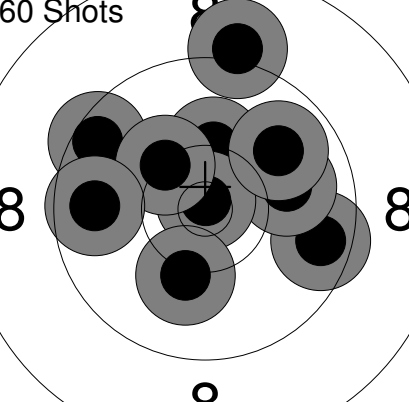
<p>Sight</p> 	<p>1: 8.0 ← 2: 10.0 ↗ 3: 9.2 ↓ 4: 9.0 ↗ 5: 9.8 ↗ 6: 10.0 ↖ 7: 9.0 ↗ 8: 9.8 ↗ 9: 10.0 ↓ 10: 10.2 ↗</p> <p>Series 93 (0x) 0 (0x)</p>	<p>Sight</p> 	<p>11: 10.0 ↓ 12: 10.7x ↓ 13: 10.2 ↗ 14: 8.1 ← 15: 10.1 ← 16: 10.9x → 17: 8.9 ↗ 18: 8.3 ↗ 19: 10.0 ←</p> <p>Series 84 (2x) 0 (0x)</p>
<p>60 Shots</p> 	<p>1: 9.8 ← 2: 9.4 ↗ 3: 10.3 ↗ 4: 9.5 ← 5: 10.4 ↗ 6: 10.4x → 7: 9.1 ↗ 8: 9.8 ↗ 9: 10.1 ↗ 10: 9.6 ↓</p> <p>Series 94 (1x) 94 (1x)</p>	<p>60 Shots</p> 	<p>11: 9.5 ↑ 12: 9.6 ↗ 13: 9.9 ↗ 14: 10.1 ↓ 15: 10.0 ← 16: 10.1 → 17: 9.0 ↓ 18: 10.0 ← 19: 7.2 ↓ 20: 10.3 ↗</p> <p>Series 93 (0x) 187 (1x)</p>
<p>60 Shots</p> 	<p>21: 9.7 ← 22: 10.2 ↗ 23: 9.0 → 24: 10.2 → 25: 8.9 ↓ 26: 9.6 ↓ 27: 9.4 ↓ 28: 9.8 ← 29: 10.0 ← 30: 10.4x ↓</p> <p>Series 93 (1x) 280 (2x)</p>	<p>60 Shots</p> 	<p>31: 9.9 ↓ 32: 9.3 ← 33: 10.5x ← 34: 9.5 ← 35: 9.6 ↗ 36: 9.9 ↓ 37: 10.1 ↓ 38: 9.7 ← 39: 9.3 ↗ 40: 10.1 →</p> <p>Series 93 (1x) 373 (3x)</p>
<p>60 Shots</p> 	<p>41: 10.1 ↗ 42: 9.3 ↓ 43: 9.1 ↗ 44: 10.4x ↗ 45: 10.2 ↓ 46: 9.6 ← 47: 10.2 ← 48: 9.3 → 49: 10.0 ↓ 50: 9.3 ←</p> <p>Series 95 (1x) 468 (4x)</p>	<p>60 Shots</p> 	<p>51: 9.6 → 52: 10.0 → 53: 10.2 ↑ 54: 10.9x ↑ 55: 9.5 ↗ 56: 10.3 ↗ 57: 9.7 ← 58: 10.2 ↓ 59: 9.1 ↑ 60: 9.9 ↗</p> <p>Series 95 (1x) 563 (5x)</p>

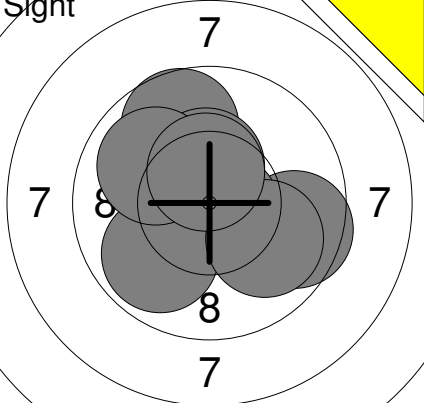
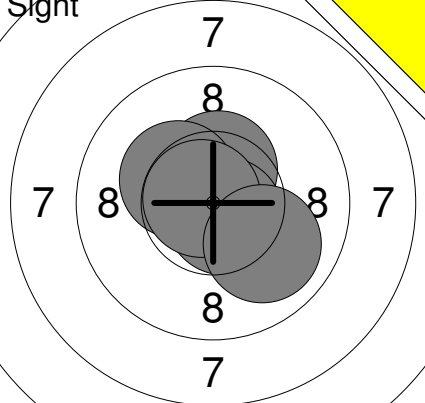
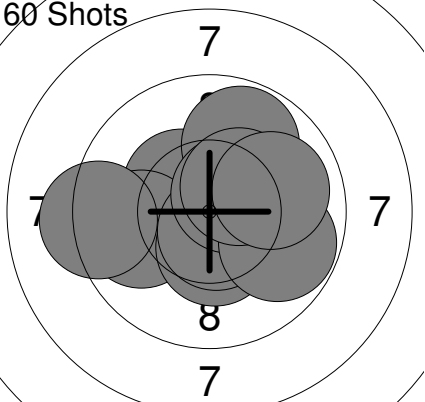
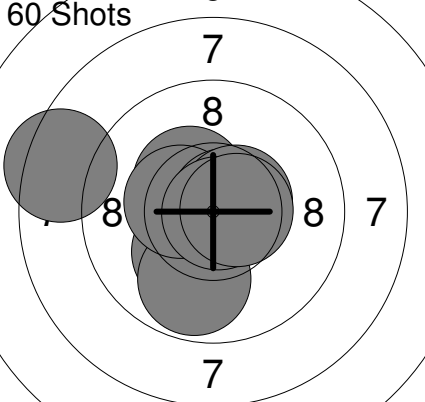
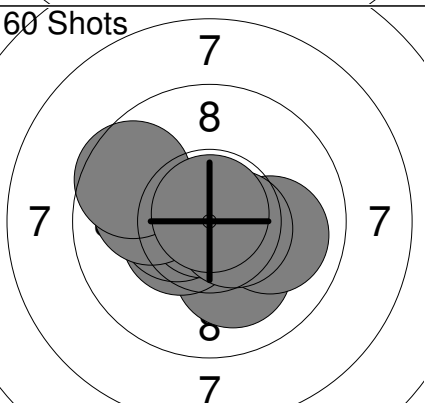
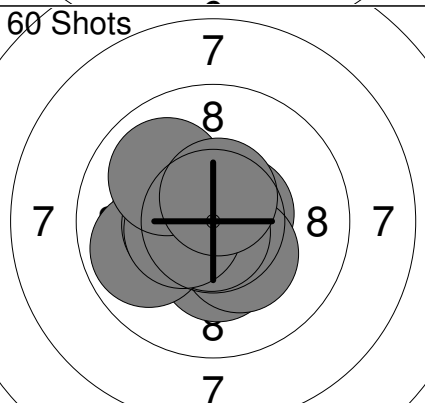
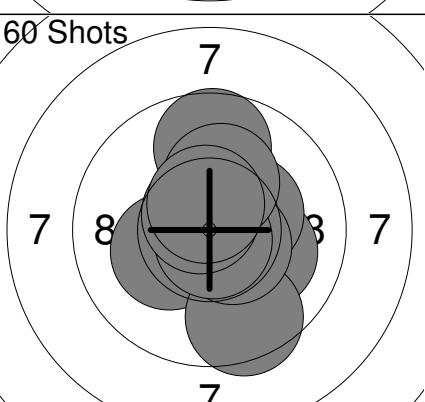
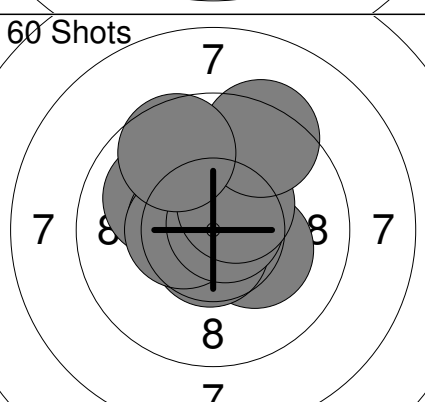
Sight 	1: 9.6 → 2: 10.6x ↙ 3: 10.5x ↑ 4: 9.7 ↗ 5: 10.7x ↘ 6: 9.9 ↙ 7: 10.4x ↑ 8: 10.0 ↗ 9: 9.9 ↘ 10: 10.5x ↑ <hr/> Series 101.8 0.0	Sight 	11: 10.4x ↑ 12: 10.3x ↗ 13: 10.7x ↘ 14: 10.8x ↗ 15: 10.0 ↘ <hr/> Series 52.2 0.0
60 Shots 	1: 10.4x ↖ 2: 9.8 ↗ 3: 9.9 ← 4: 10.4x ↘ 5: 10.6x ↘ 6: 10.5x ↗ 7: 9.8 → 8: 9.2 ← 9: 10.4x ↗ 10: 10.0 → <hr/> Series 101.0 101.0	60 Shots 	11: 10.2x ↘ 12: 10.8x ↖ 13: 10.4x ↗ 14: 9.8 ↘ 15: 10.4x ← 16: 8.4 ← 17: 10.7x → 18: 10.5x → 19: 10.9x → 20: 10.6x → <hr/> Series 102.7 203.7
60 Shots 	21: 10.1 ↘ 22: 10.4x ← 23: 10.1 ← 24: 10.5x ← 25: 10.0 → 26: 10.9x ↗ 27: 10.6x → 28: 10.0 ← 29: 9.6 ↖ 30: 10.8x ↑ <hr/> Series 103.0 306.7	60 Shots 	31: 10.3x ↓ 32: 10.6x → 33: 10.3x ↘ 34: 10.8x ↘ 35: 10.3x ← 36: 9.9 ← 37: 10.5x ← 38: 10.5x ← 39: 10.0 ↗ 40: 10.6x ↑ <hr/> Series 103.8 410.5
60 Shots 	41: 10.1 → 42: 10.3x ← 43: 9.5 ↘ 44: 10.3x → 45: 10.5x ↘ 46: 9.7 ↑ 47: 10.8x ↘ 48: 10.7x ↗ 49: 10.2x ↑ 50: 10.6x ↑ <hr/> Series 102.7 513.2	60 Shots 	51: 10.4x ↑ 52: 10.0 ↖ 53: 10.2x → 54: 10.5x ← 55: 10.7x ↘ 56: 10.5x ← 57: 10.7x → 58: 10.4x ↗ 59: 9.4 ↗ 60: 9.6 ↖ <hr/> Series 102.4 615.6

Relay **3** Lane **11** **ROMANOW Emerson**

2023 AHA Memorial SK JR WR

18.11.2023 2023 Memorial Q Alberta Handgun Association

Comment Signature

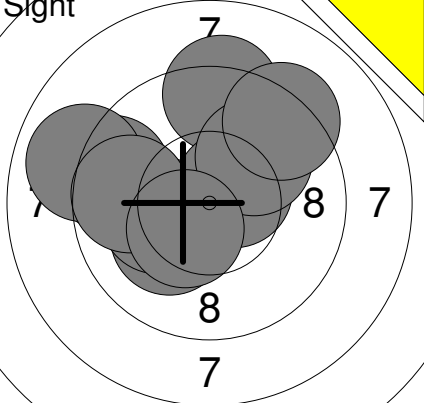
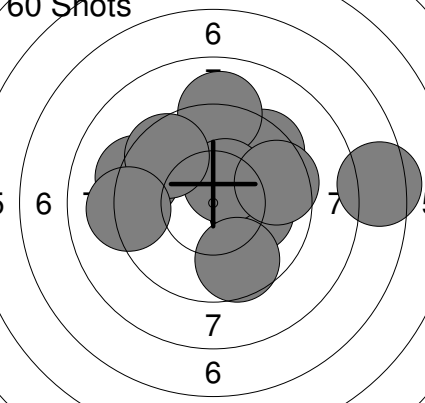
Sight 	1: 10.2x ↙ 2: 10.2x ← 3: 9.3 ↑ 4: 10.5x ↗ 5: 9.4 ← 6: 8.9 ↖ 7: 10.0 ↗ 8: 9.7 ← 9: 10.4x ↙ 10: 9.3 ↗	60 Shots 	1: 10.1 → 2: 7.4 → 3: 9.4 ↗ 4: 9.0 ↑ 5: 9.2 ← 6: 10.4x ↗ 7: 9.5 → 8: 9.6 ↓ 9: 9.6 ↗ 10: 9.1 ←
	Series 97.9 0.0		Series 93.3 93.3

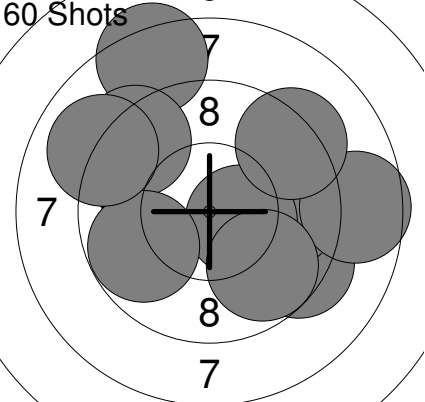
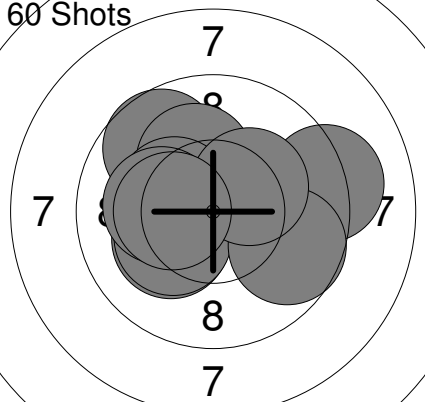
60 Shots 	11: 9.3 → 12: 8.3 ↗ 13: 9.8 → 14: 9.3 ↗ 15: 8.6 → 16: 10.4x → 17: 9.2 ↗ 18: 9.8 ← 19: 9.0 ↗ 20: 9.7 ↓	60 Shots 	21: 9.7 ↗ 22: 10.2x ← 23: 10.1 ↑ 24: 10.3x ← 25: 9.2 → 26: 10.2x ← 27: 9.7 → 28: 10.3x ↗ 29: 10.2x ← 30: 10.3x ←
	Series 93.4 186.7		Series 100.2 286.9

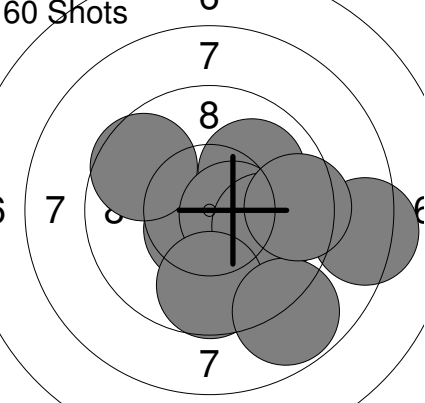
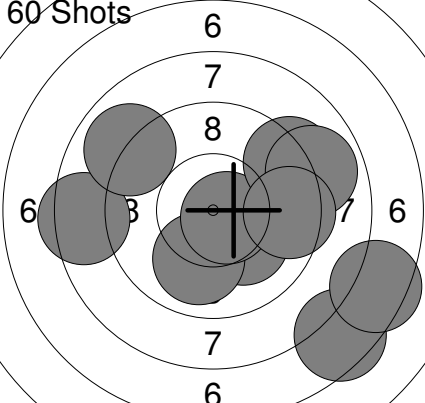
60 Shots 	31: 10.6x ↙ 32: 9.6 ↗ 33: 10.0 → 34: 10.0 ↗ 35: 10.5x → 36: 8.3 → 37: 10.0 → 38: 9.7 ↓ 39: 8.8 ↓ 40: 9.5 →	60 Shots 	41: 7.5 ↓ 42: 8.4 ← 43: 10.1 ↓ 44: 7.4 → 45: 10.0 ↓ 46: 10.6x ↓ 47: 9.2 ↗ 48: 8.9 → 49: 9.5 → 50: 8.9 ↗
	Series 97.0 383.9		Series 90.5 474.4

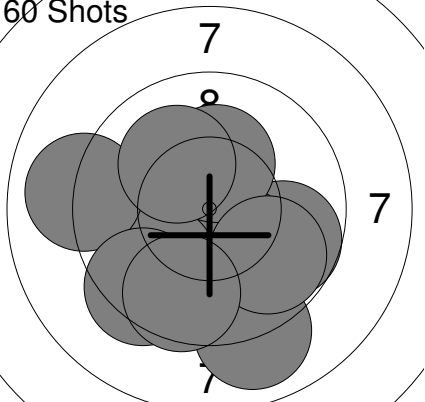
60 Shots 	51: 9.7 → 52: 9.0 ↓ 53: 10.3x ↓ 54: 10.3x ↑ 55: 9.8 ↖ 56: 9.0 ← 57: 10.1 ↗ 58: 9.4 ↖ 59: 9.8 ↓ 60: 9.6 ↓	
	Series 97.0 571.4	

Relay 3	Lane 12	FU Vivian (weimiao)
-------------------	-------------------	----------------------------

2023 AHA Memorial	BC	JR	WR
-------------------	----	----	----

18.11.2023	2023 Memorial Q	Alberta Handgun Association
------------	-----------------	-----------------------------

Comment	Signature
---------	-----------

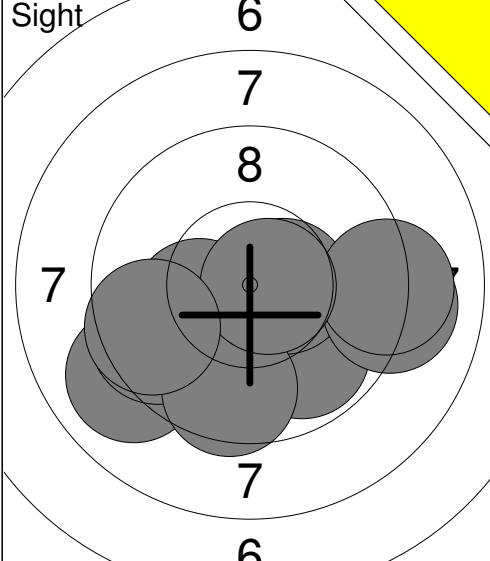
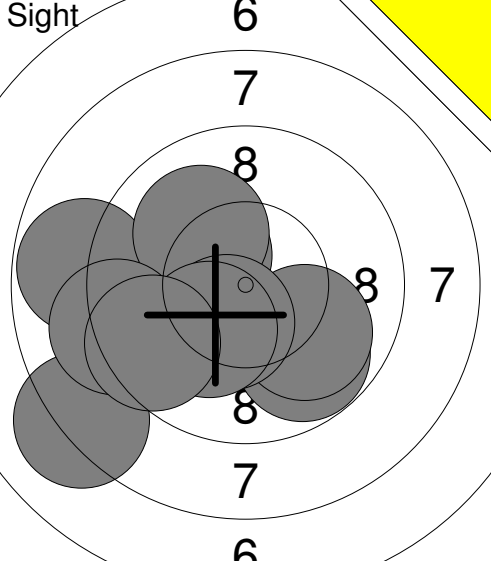
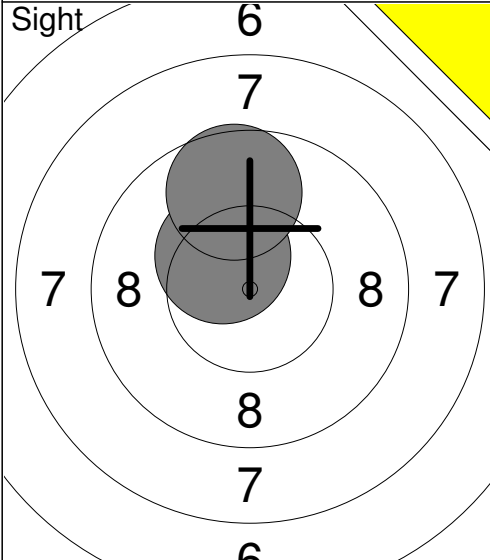
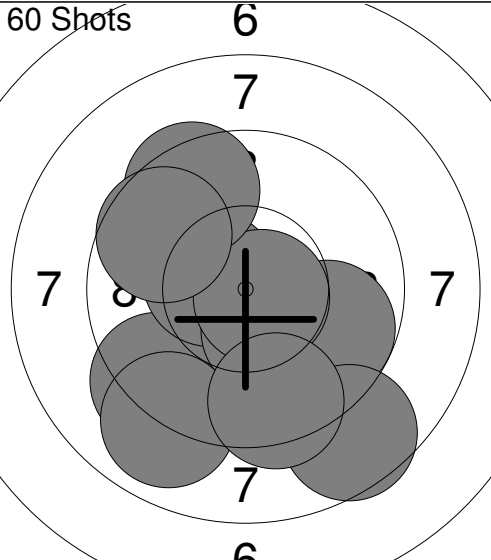
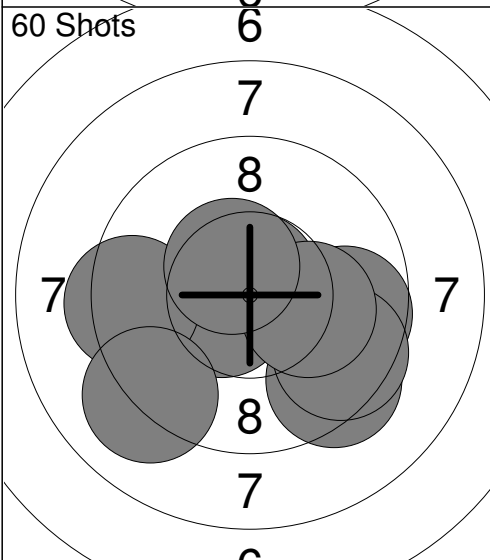
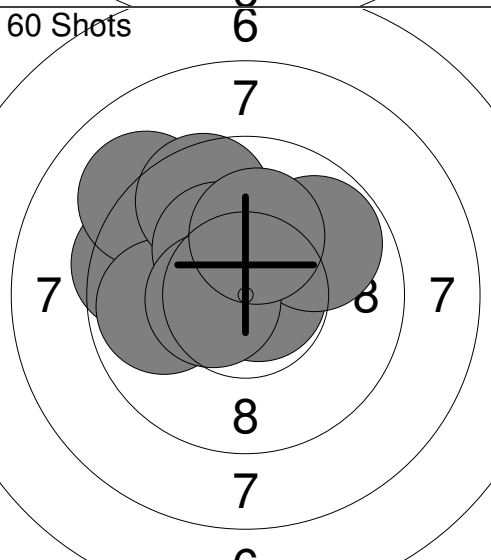
<p>Sight</p>  <p style="text-align: center;">6 7 8 7 7</p>	<p>1: 10.2x ← 2: 9.8 ↓ 3: 9.0 ← 4: 10.5x → 5: 9.5 ← 6: 9.5 ↓ 7: 9.1 → 8: 9.1 → 9: 10.7x → 10: 9.5 ←</p> <p>Series 96.9 0.0</p>	<p>Sight</p>  <p style="text-align: center;">6 7 8 8 7</p>	<p>11: 9.8 ↓ 12: 10.3x ↗ 13: 8.8 ← 14: 10.0 ↗ 15: 8.1 ← 16: 9.9 ↓ 17: 10.4x ↓ 18: 9.2 ← 19: 10.2x ↓ 20: 9.5 ←</p> <p>Series 96.2 0.0</p>
<p>Sight</p>  <p style="text-align: center;">6 6 7 8 7</p>	<p>21: 10.4x ↗ 22: 9.7 ↑</p> <p>Series 20.1 0.0</p>	<p>60 Shots</p>  <p style="text-align: center;">6 6 7 8 7</p>	<p>1: 9.3 ↓ 2: 10.5x ← 3: 10.3x ↓ 4: 9.8 → 5: 8.6 ↓ 6: 10.7x → 7: 8.9 ↓ 8: 9.5 ↗ 9: 9.6 ↗ 10: 9.4 ↓</p> <p>Series 96.6 96.6</p>
<p>60 Shots</p>  <p style="text-align: center;">6 6 7 8 7</p>	<p>11: 9.4 ↓ 12: 10.7x ↑ 13: 9.7 → 14: 9.5 ↓ 15: 9.7 ← 16: 10.5x ← 17: 9.4 ← 18: 9.1 ↓ 19: 10.2x → 20: 10.5x ↗</p> <p>Series 98.7 195.3</p>	<p>60 Shots</p>  <p style="text-align: center;">6 6 7 8 7</p>	<p>21: 9.5 ← 22: 9.1 ↗ 23: 10.2x ↑ 24: 10.8x → 25: 9.9 ← 26: 9.6 ↗ 27: 9.8 ↗ 28: 10.3x ↗ 29: 10.5x ← 30: 10.2x ↑</p> <p>Series 99.9 295.2</p>

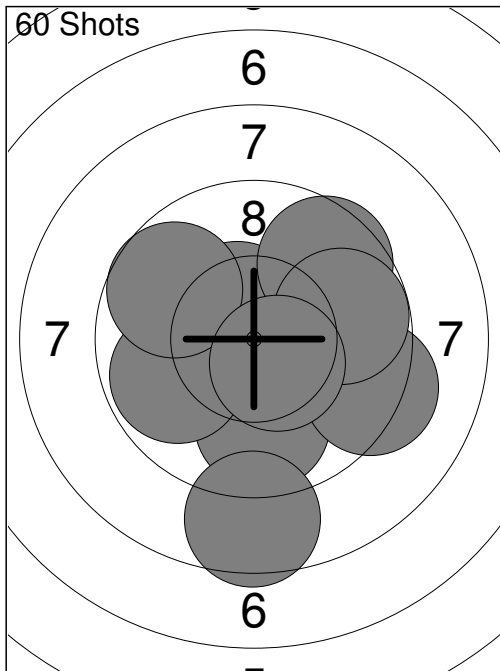

31:	9.8	↓
32:	10.8x	↗
33:	10.5x	↖
34:	9.3	→
35:	8.6	↓
36:	9.6	↗
37:	9.8	→
38:	9.8	←
39:	9.7	↖
40:	10.5x	↘
Series	98.4	
	393.6	

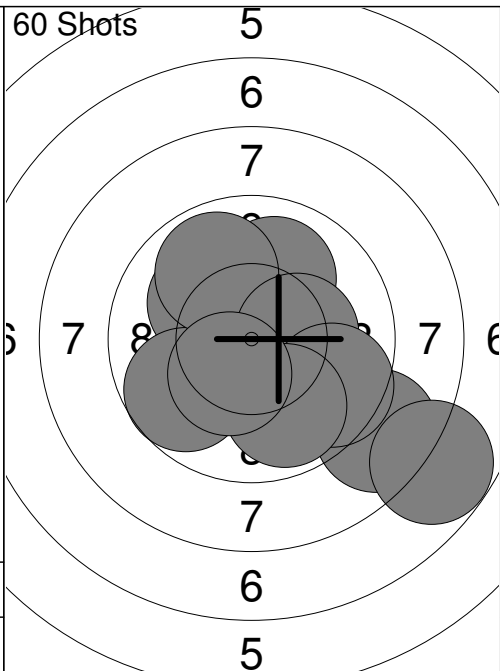

41:	10.1	↖
42:	10.0	↗
43:	9.7	↖
44:	9.9	↗
45:	10.3x	→
46:	8.7	↘
47:	7.8	↘
48:	9.6	↘
49:	9.9	↓
50:	10.4x	↘
Series	96.4	
	490.0	

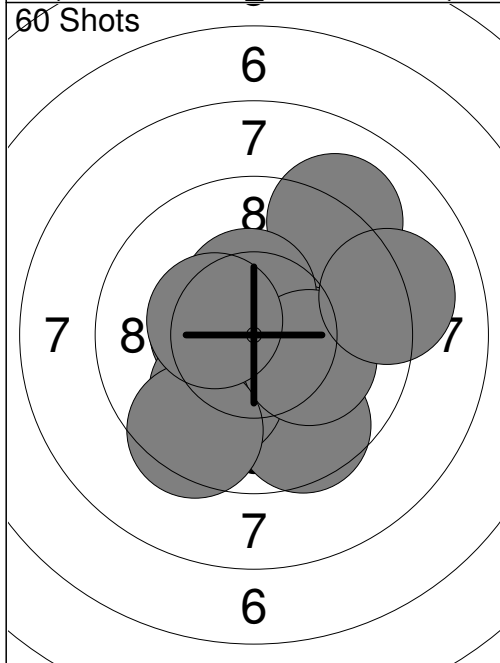

51:	10.6x	↗
52:	9.1	↗
53:	10.5x	←
54:	9.6	↓
55:	10.0	↘
56:	10.4x	↑
57:	10.2x	→
58:	9.1	→
59:	9.5	↘
60:	10.4x	↖
Series	99.4	
	589.4	

--	--