

Relay 1	Lane 12	LI Ethan
-------------------	-------------------	-----------------

2023 SFC Pistol Nationals	MA	F	MP
---------------------------	----	---	----

16.07.2023	2023 PN AP60M Finals	Alberta Handgun Association
------------	----------------------	-----------------------------

Comment	Signature
---------	-----------

<p>Sight</p>	<p>1: 10.4x ↗</p> <p>2: 9.4 ←</p> <p>3: 8.7 ↗</p> <p>4: 9.0 ↑</p> <p>5: 9.5 ←</p> <p>6: 9.4 ↘</p>	<p>1. Series Finals 7</p>	<p>1: 7.9 ←</p> <p>2: 8.7 ↘</p> <p>3: 9.5 ↑</p> <p>4: 8.8 ↖</p> <p>5: 9.5 ↗</p>
	<p>Series 56.4</p> <p>0.0</p>		<p>Series 44.4</p> <p>44.4</p>

<p>2. Series Finals</p>	<p>1: 10.5x ↓</p> <p>2: 10.7x ↙</p> <p>3: 9.7 ←</p> <p>4: 10.8x ↓</p> <p>5: 9.7 ↓</p>	<p>3. Series Finals</p>	<p>1: 9.3 ←</p> <p>2: 10.0 ↗</p>
	<p>Series 51.4</p> <p>95.8</p>		<p>Series 19.3</p> <p>115.1</p>

<p>4. Series Finals</p>	<p>1: 9.4 ↑</p> <p>2: 10.5x →</p>	<p>5. Series Finals</p>	<p>1: 10.0 ↗</p> <p>2: 9.6 ↓</p>
	<p>Series 19.9</p> <p>135.0</p>		<p>Series 19.6</p> <p>154.6</p>

Relay 1	Lane 13	NORMAN Seth
-------------------	-------------------	--------------------

2023 SFC Pistol Nationals	SK	F	MP
---------------------------	----	---	----

16.07.2023	2023 PN AP60M Finals	Alberta Handgun Association
------------	----------------------	-----------------------------

Comment	Signature
---------	-----------

<p>Sight</p>	<p>1: 9.5 →</p> <p>2: 9.0 ↑</p> <p>3: 9.9 ↑</p> <p>4: 10.1 ↗</p> <p>5: 9.4 ↑</p>	<p>1. Series Finals</p>	<p>1: 8.4 ↓</p> <p>2: 8.2 ↑</p> <p>3: 9.6 →</p> <p>4: 9.6 ←</p> <p>5: 9.0 ↑</p>
	<p>Series 47.9</p> <p>0.0</p>		<p>Series 44.8</p> <p>44.8</p>

<p>2. Series Finals</p>	<p>1: 10.5x ↗</p> <p>2: 10.4x ↑</p> <p>3: 10.0 ↘</p> <p>4: 9.0 ↗</p> <p>5: 10.0 ↓</p>	<p>3. Series Finals</p>	<p>1: 10.6x ↗</p> <p>2: 9.9 ↘</p>
	<p>Series 49.9</p> <p>94.7</p>		<p>Series 20.5</p> <p>115.2</p>

<p>4. Series Finals</p>	<p>1: 10.2 ↗</p> <p>2: 9.0 ↗</p>	
	<p>Series 19.2</p> <p>134.4</p>	

Relay 1	Lane 14	OZER Tugrul
-------------------	-------------------	--------------------

2023 SFC Pistol Nationals	AB	F	MP
---------------------------	----	---	----

16.07.2023	2023 PN AP60M Finals	Alberta Handgun Association
------------	----------------------	-----------------------------

Comment	Signature
---------	-----------

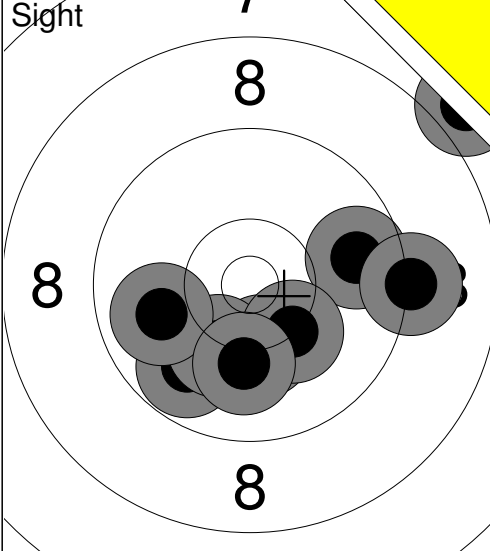
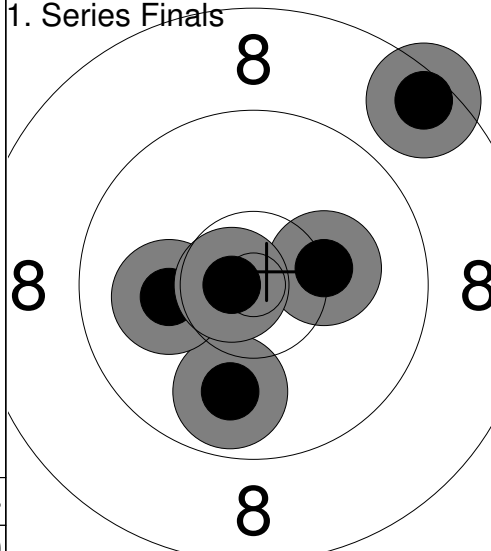
<p>Sight</p> 	<p>1. Series Finals</p> 	<p>1: 10.2 →</p> <p>2: 9.9 ↓</p> <p>3: 10.1 ←</p> <p>4: 8.5 ↗</p> <p>5: 10.7x ←</p>
<p>1: 9.8 ↙</p> <p>2: 9.7 →</p> <p>3: 10.3 ↓</p> <p>4: 10.2 ↓</p> <p>5: 9.2 →</p> <p>6: 9.9 ←</p> <p>7: 7.9 ↗</p> <p>8: 10.3 ↘</p> <p>9: 10.1 ↓</p>	<p>Series 87.4</p> <p>0.0</p>	<p>Series 49.4</p> <p>49.4</p>

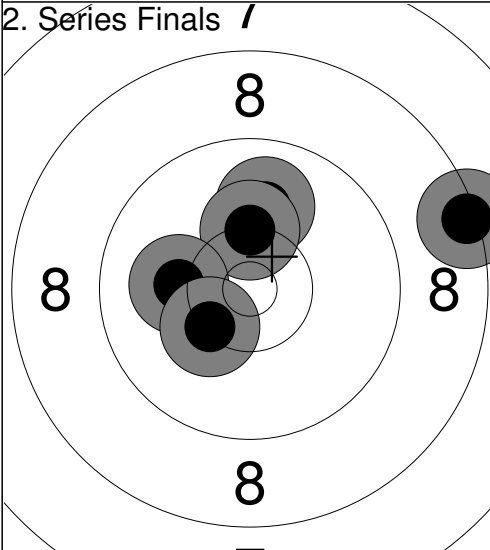
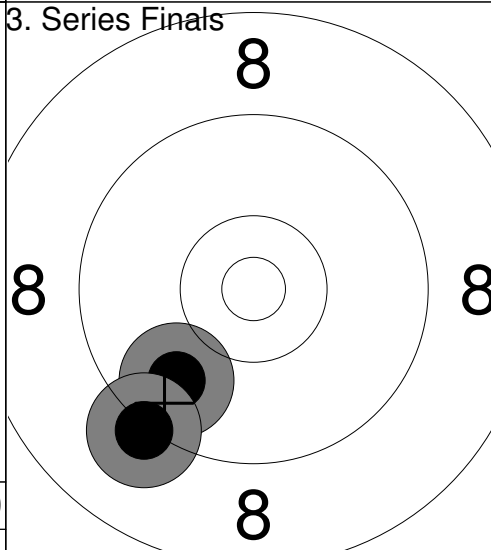
<p>2. Series Finals</p> 	<p>3. Series Finals</p> 	<p>1: 9.8 ↙</p> <p>2: 9.2 ↙</p>
<p>1: 10.0 ↑</p> <p>2: 10.3 ↑</p> <p>3: 8.3 →</p> <p>4: 10.1 ←</p> <p>5: 10.3 ↙</p>	<p>Series 49.0</p> <p>98.4</p>	<p>Series 19.0</p> <p>117.4</p>

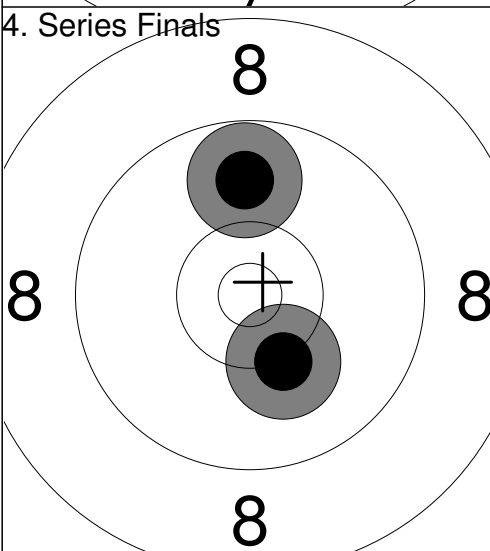
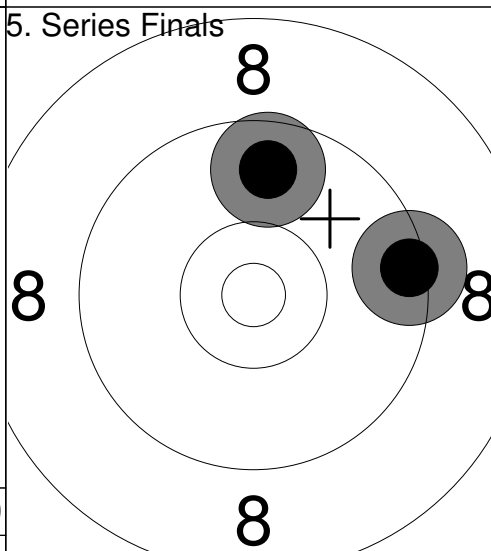
<p>4. Series Finals</p> 	<p>5. Series Finals</p> 	<p>1: 9.4 →</p> <p>2: 9.7 ↑</p>
<p>1: 9.8 ↑</p> <p>2: 10.2 ↓</p>	<p>Series 20.0</p> <p>137.4</p>	<p>Series 19.1</p> <p>156.5</p>

6. Series Finals /

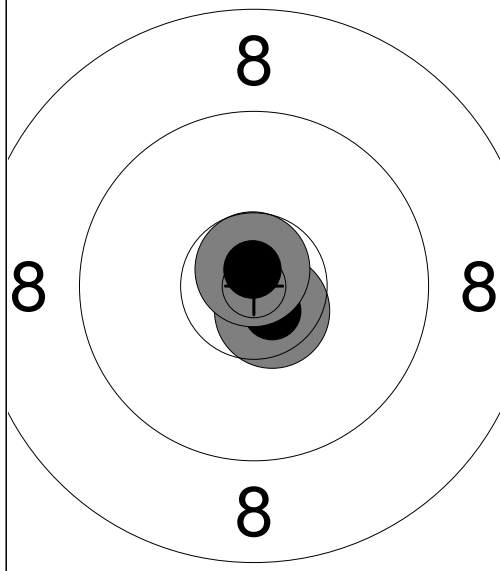

1: 10.6x ↘
2: 10.8x ↑

Series 21.4
177.9

7. Series Finals /

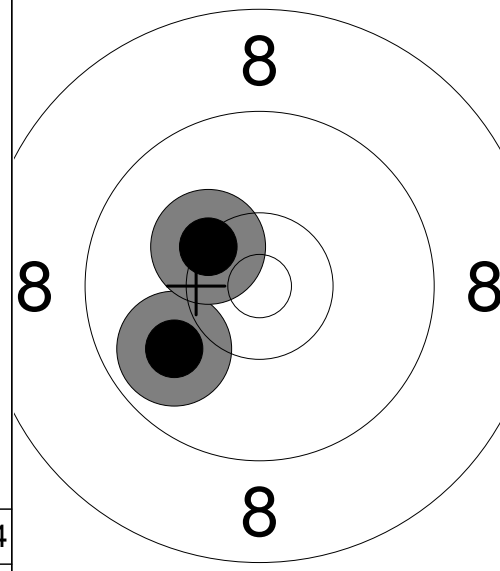

1: 9.9 ↙
2: 10.3 ↖

Series 20.2
198.1

8. Series Finals /

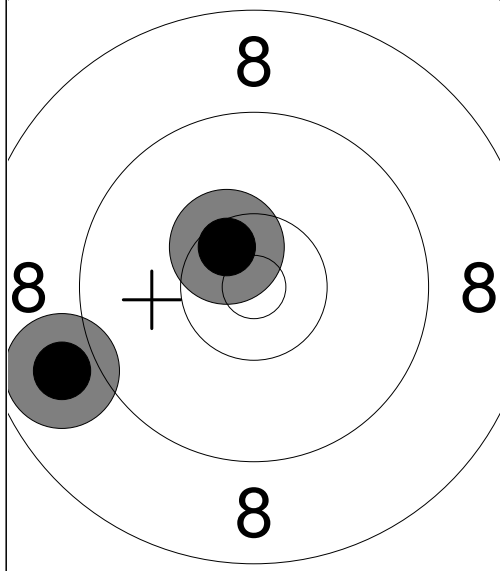

1: 8.9 ↙
2: 10.5x ↖

Series 19.4
217.5

9. Series Finals /

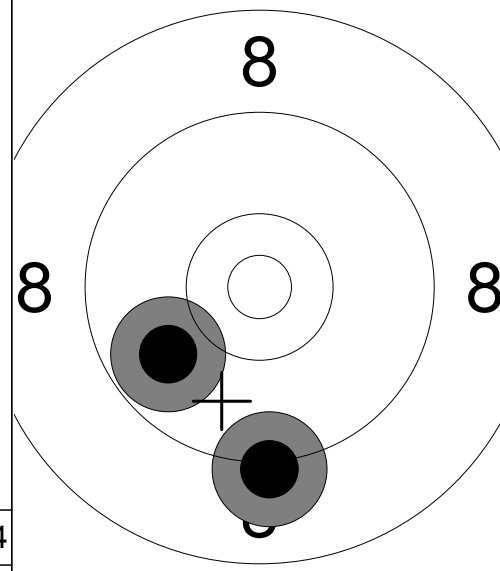

1: 9.8 ↙
2: 9.2 ↓

Series 19.0
236.5

Comment	Signature		
---------	-----------	--	--

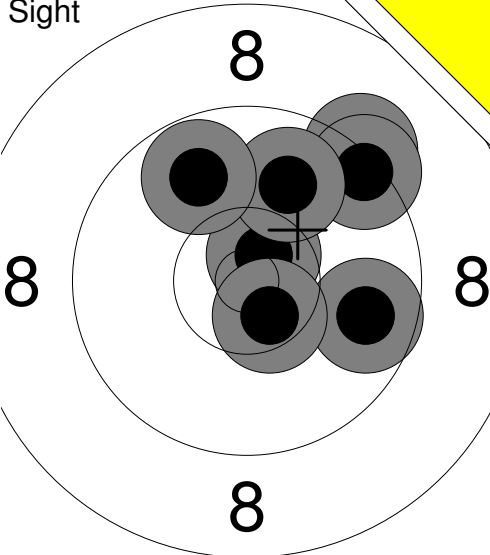
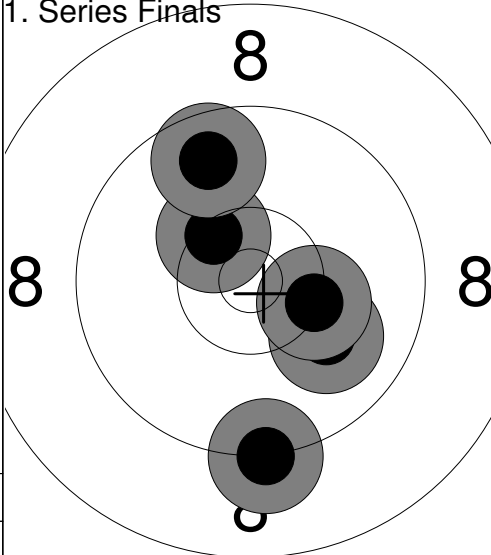
<p>Sight</p> 	<p>1: 10.7x ↗ 2: 9.3 ↗ 3: 9.4 ↗ 4: 9.9 ↗ 5: 9.8 ↗ 6: 9.7 → 7: 10.5x ↘</p> <p>Series 69.3 0.0</p>	<p>1. Series Finals</p>  <p>1: 10.4x ↗ 2: 10.0 ↘ 3: 10.3 → 4: 9.2 ↓ 5: 9.7 ↗</p> <p>Series 49.6 49.6</p>
---	--	--

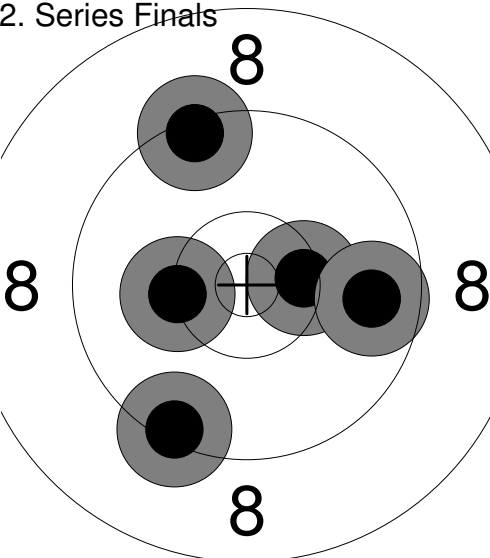
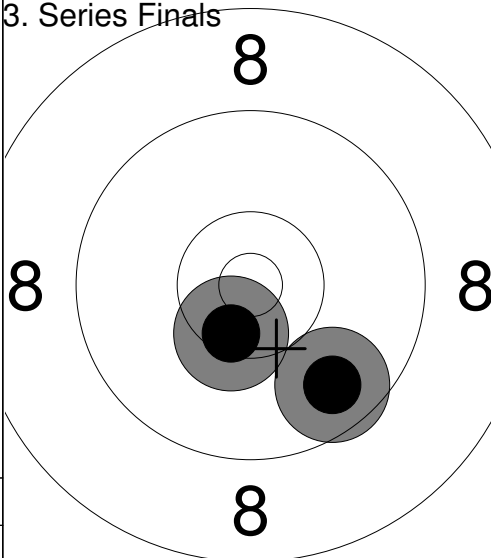
<p>2. Series Finals</p> 	<p>1: 10.3 ← 2: 9.4 ↗ 3: 10.4x → 4: 9.4 ↓ 5: 9.7 →</p> <p>Series 49.2 98.8</p>	<p>3. Series Finals</p>  <p>1: 9.7 ↘ 2: 10.4x ↘</p> <p>Series 20.1 118.9</p>
---	--	---

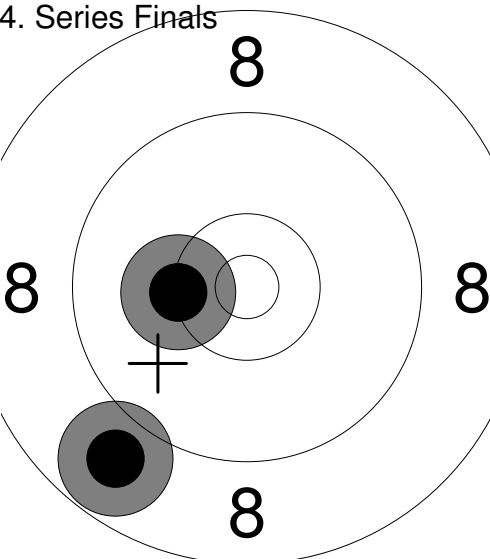
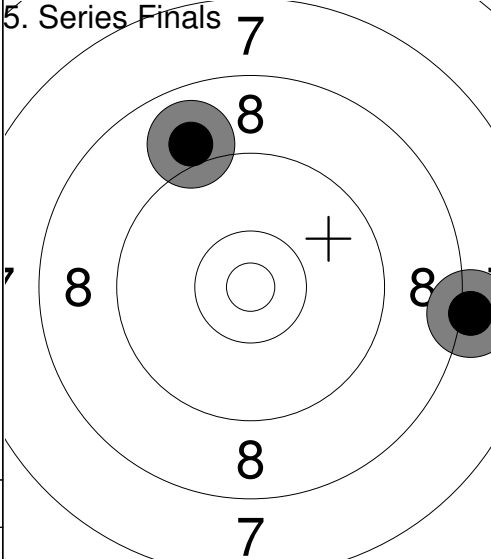
<p>4. Series Finals</p> 	<p>1: 8.8 ↘ 2: 10.3 ←</p> <p>Series 19.1 138.0</p>	<p>5. Series Finals</p>  <p>1: 8.1 → 2: 9.0 ↗</p> <p>Series 17.1 155.1</p>
--	--	--

6. Series Finals /

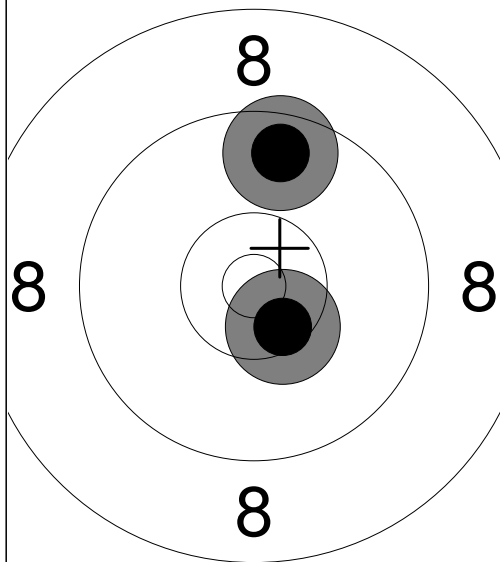

1: 10.5x ↘
2: 9.6 ↑

Series 20.1
175.2

7. Series Finals /

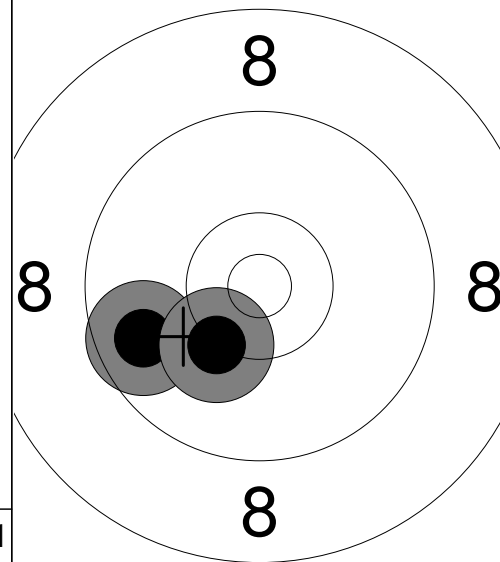

1: 9.7 ↙
2: 10.2 ↘

Series 19.9
195.1

8. Series Finals /

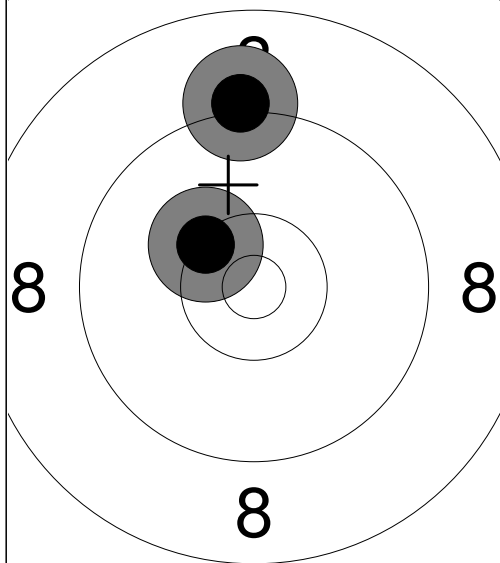

1: 9.1 ↑
2: 10.3 ↙

Series 19.4
214.5

9. Series Finals /

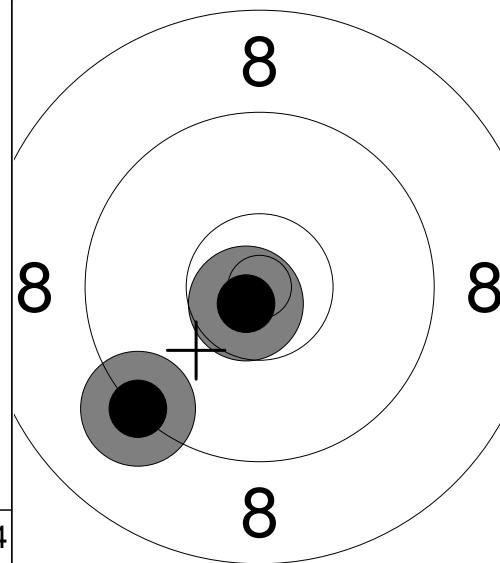

1: 10.7x ↘
2: 9.3 ↘

Series 20.0
234.5

Comment	Signature
---------	-----------

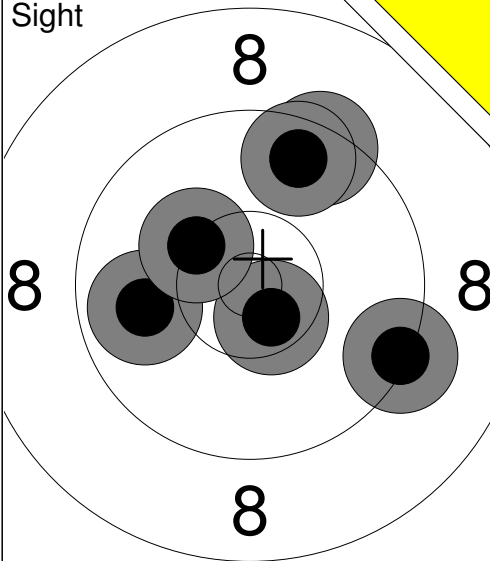
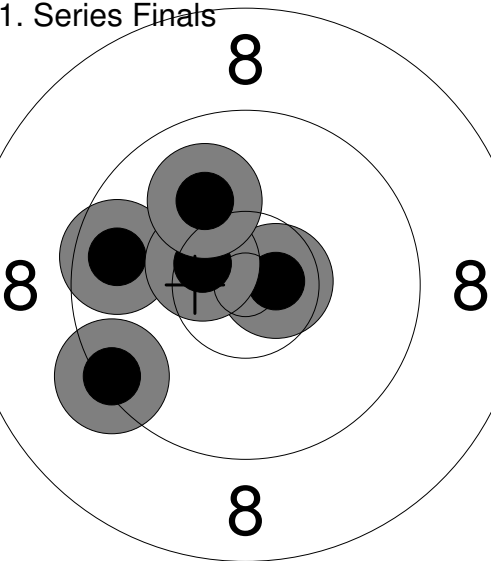
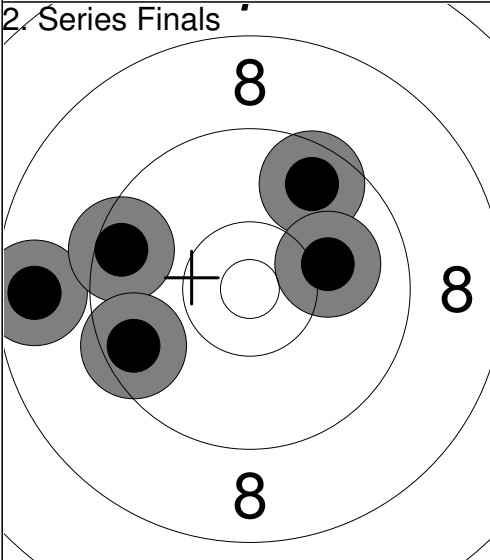
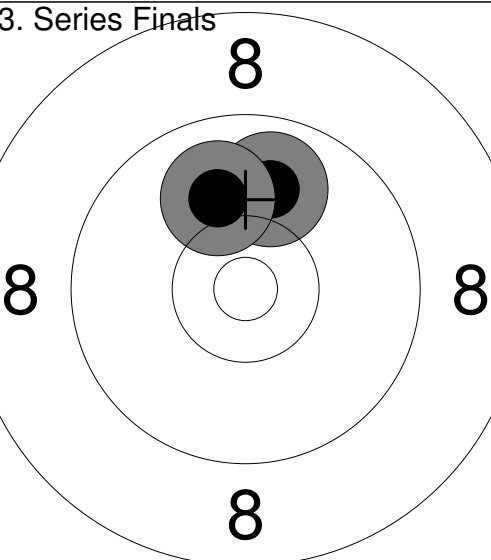
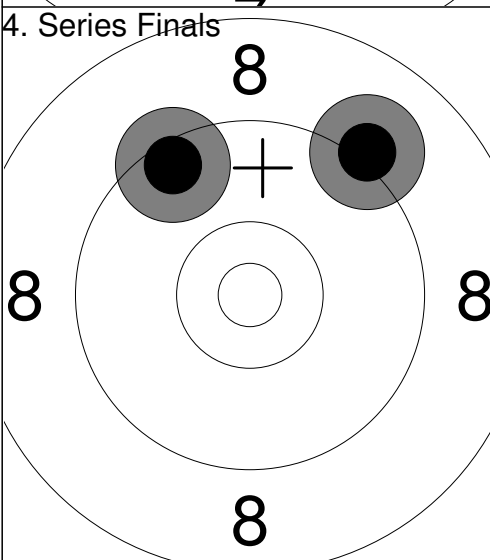
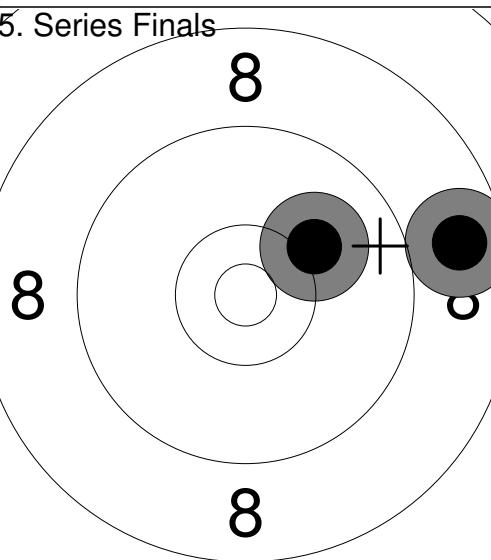
<p>Sight</p> 	<p>1. Series Finals</p> 	<p>1: 9.7 ←</p> <p>2: 10.6x →</p> <p>3: 10.5x ↖</p> <p>4: 9.4 ↙</p> <p>5: 10.0 ↗</p>
<p>1: 9.4 ↗</p> <p>2: 9.3 →</p> <p>3: 9.6 ↗</p> <p>4: 9.9 ←</p> <p>5: 10.6x ↘</p> <p>6: 10.3 ↗</p>	<p>Series 59.1</p> <p>0.0</p>	<p>Series 50.2</p> <p>50.2</p>
<p>2. Series Finals</p> 	<p>3. Series Finals</p> 	<p>1: 9.9 ↗</p> <p>2: 10.0 ↗</p>
<p>1: 9.6 ↗</p> <p>2: 8.6 ←</p> <p>3: 9.5 ↖</p> <p>4: 9.6 ↖</p> <p>5: 10.1 →</p>	<p>Series 47.4</p> <p>97.6</p>	<p>Series 19.9</p> <p>117.5</p>
<p>4. Series Finals</p> 	<p>5. Series Finals</p> 	<p>1: 8.7 →</p> <p>2: 10.1 ↗</p>
<p>1: 9.1 ↗</p> <p>2: 9.5 ↗</p>	<p>Series 18.6</p> <p>136.1</p>	<p>Series 18.8</p> <p>154.9</p>

6. Series Finals /

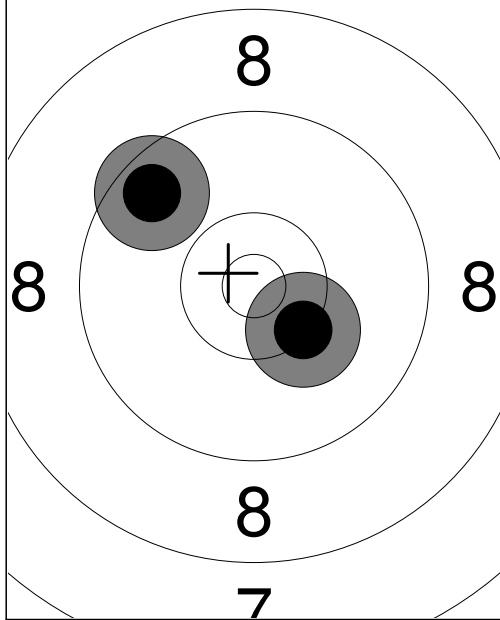

1: 10.3 ↘
2: 9.6 ↗

Series 19.9
174.8

7. Series Finals /

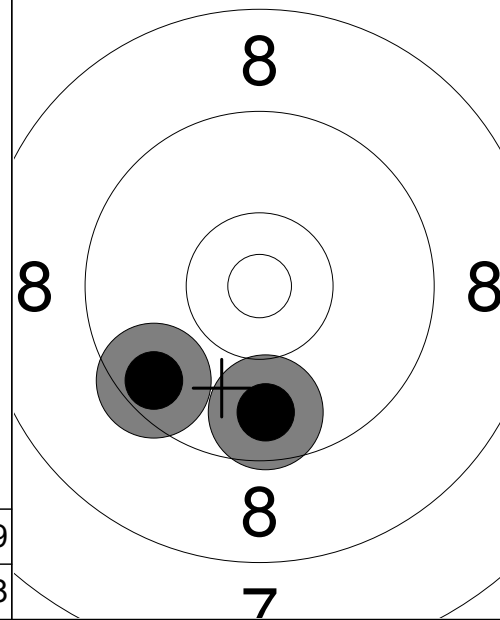

1: 9.7 ↓
2: 9.6 ↙

Series 19.3
194.1

8. Series Finals /

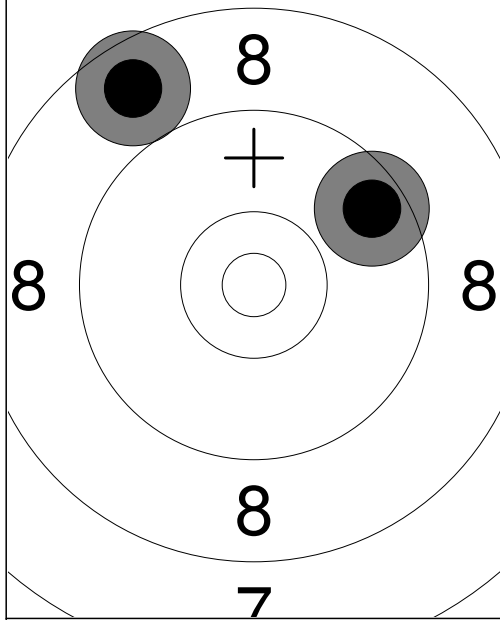

1: 8.7 ↖
2: 9.6 ↗

Series 18.3
212.4

Relay 1	Lane 17	HYNES Mark
-------------------	-------------------	-------------------

2023 SFC Pistol Nationals	ON	F	MP
---------------------------	----	---	----

16.07.2023	2023 PN AP60M Finals	Alberta Handgun Association
------------	----------------------	-----------------------------

Comment	Signature
---------	-----------

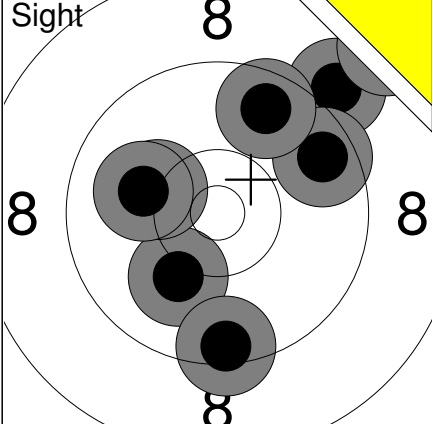
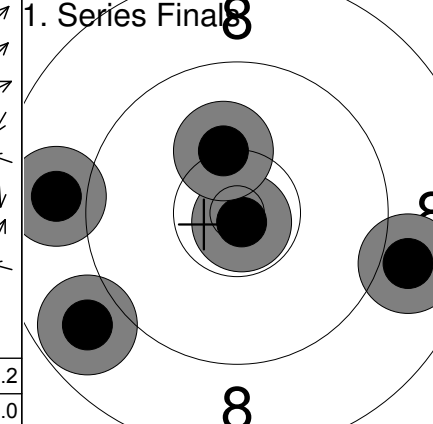
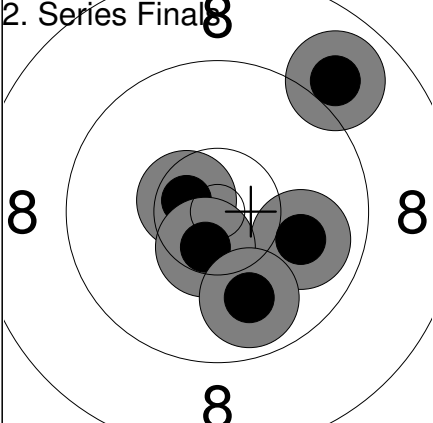
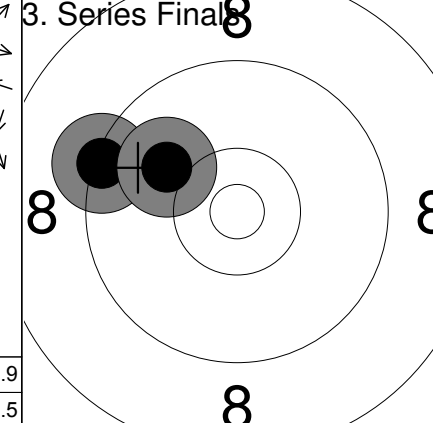
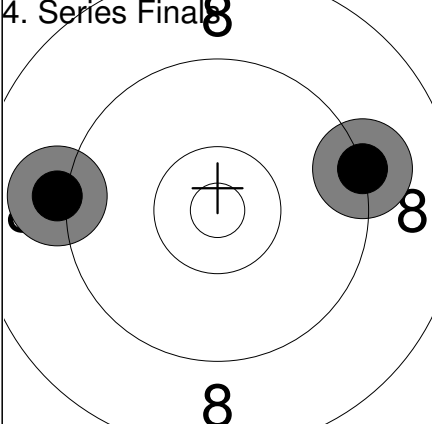
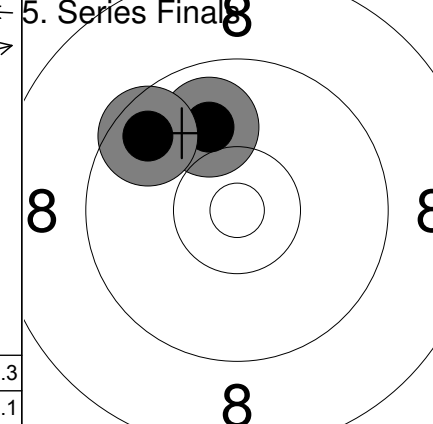
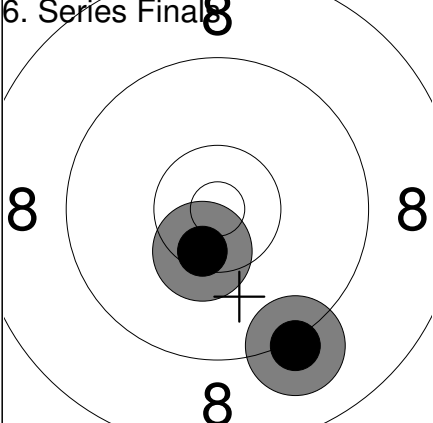
<p>Sight</p> 	<p>1: 9.0 ↗ 2: 8.2 ↗ 3: 9.6 → 4: 10.1 ↘ 5: 10.2 ← 6: 9.4 ↓ 7: 9.6 ↗ 8: 10.1 ←</p>	<p>1. Series Final</p> 	<p>1: 10.8x ↓ 2: 8.9 → 3: 10.2 ↑ 4: 8.8 ↘ 5: 8.9 ←</p>								
<table style="width:100%; border-collapse: collapse;"> <tr> <td style="width:50%;">Series</td> <td style="width:50%; text-align: right;">76.2</td> </tr> <tr> <td></td> <td style="text-align: right;">0.0</td> </tr> </table>		Series	76.2		0.0	<table style="width:100%; border-collapse: collapse;"> <tr> <td style="width:50%;">Series</td> <td style="width:50%; text-align: right;">47.6</td> </tr> <tr> <td></td> <td style="text-align: right;">47.6</td> </tr> </table>		Series	47.6		47.6
Series	76.2										
	0.0										
Series	47.6										
	47.6										
<p>2. Series Final</p> 	<p>1: 8.9 ↗ 2: 10.0 → 3: 10.6x ← 4: 10.5x ↓ 5: 9.9 ↓</p>	<p>3. Series Final</p> 	<p>1: 9.3 ← 2: 10.0 ↖</p>								
<table style="width:100%; border-collapse: collapse;"> <tr> <td style="width:50%;">Series</td> <td style="width:50%; text-align: right;">49.9</td> </tr> <tr> <td></td> <td style="text-align: right;">97.5</td> </tr> </table>		Series	49.9		97.5	<table style="width:100%; border-collapse: collapse;"> <tr> <td style="width:50%;">Series</td> <td style="width:50%; text-align: right;">19.3</td> </tr> <tr> <td></td> <td style="text-align: right;">116.8</td> </tr> </table>		Series	19.3		116.8
Series	49.9										
	97.5										
Series	19.3										
	116.8										
<p>4. Series Final</p> 	<p>1: 9.1 ← 2: 9.2 →</p>	<p>5. Series Final</p> 	<p>1: 10.0 ↑ 2: 9.6 ↖</p>								
<table style="width:100%; border-collapse: collapse;"> <tr> <td style="width:50%;">Series</td> <td style="width:50%; text-align: right;">18.3</td> </tr> <tr> <td></td> <td style="text-align: right;">135.1</td> </tr> </table>		Series	18.3		135.1	<table style="width:100%; border-collapse: collapse;"> <tr> <td style="width:50%;">Series</td> <td style="width:50%; text-align: right;">19.6</td> </tr> <tr> <td></td> <td style="text-align: right;">154.7</td> </tr> </table>		Series	19.6		154.7
Series	18.3										
	135.1										
Series	19.6										
	154.7										
<p>6. Series Final</p> 	<p>1: 10.4x ↓ 2: 9.2 ↓</p>										
<table style="width:100%; border-collapse: collapse;"> <tr> <td style="width:50%;">Series</td> <td style="width:50%; text-align: right;">19.6</td> </tr> <tr> <td></td> <td style="text-align: right;">174.3</td> </tr> </table>		Series	19.6		174.3						
Series	19.6										
	174.3										

Relay **1** Lane **18** **BURNS Stuart**

2023 SFC Pistol Nationals ON F MP

16.07.2023 2023 PN AP60M Finals Alberta Handgun Association

Comment Signature

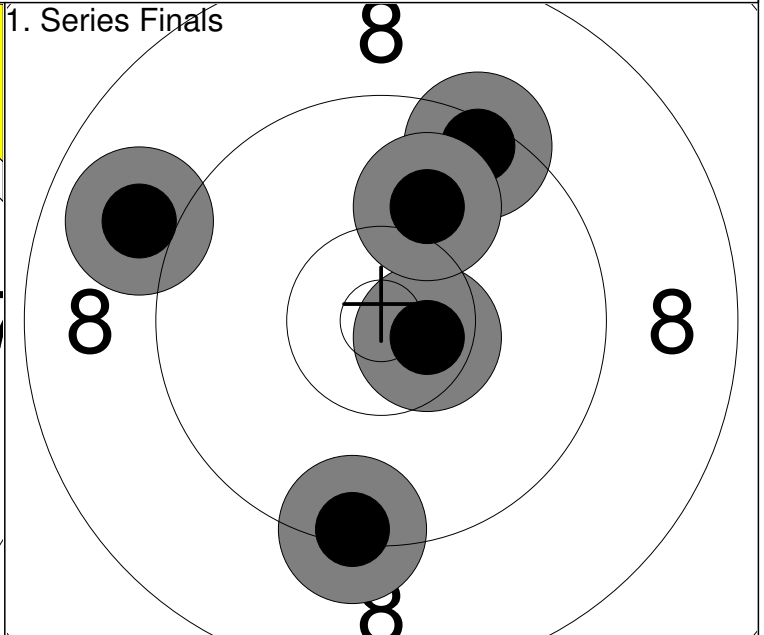
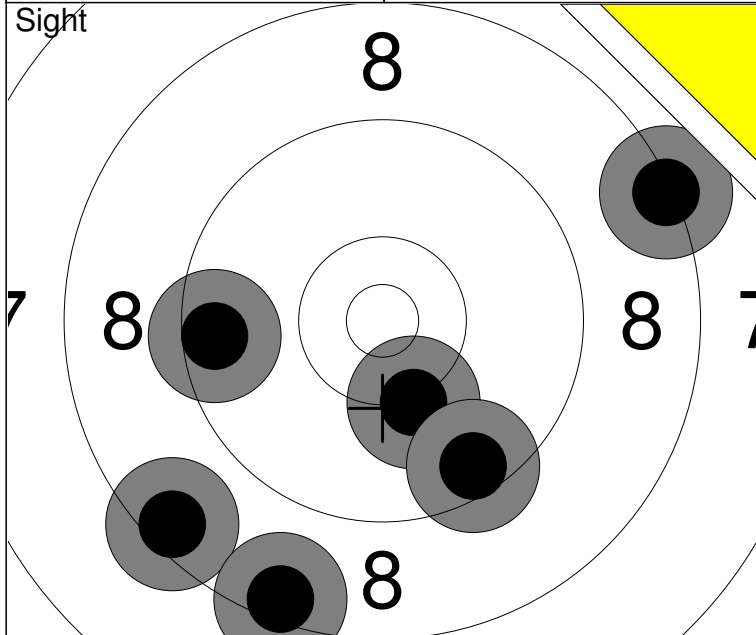

1: 8.4 ↙	6: 9.5 ↘	Series 54.3
2: 8.3 →		
3: 9.5 ←		0.0
4: 8.4 ↘		
5: 10.2 ↘		

1: 10.6x →	Series 48.3
2: 9.0 ←	
3: 9.4 ↗	48.3
4: 10.0 ↗	
5: 9.3 ↘	

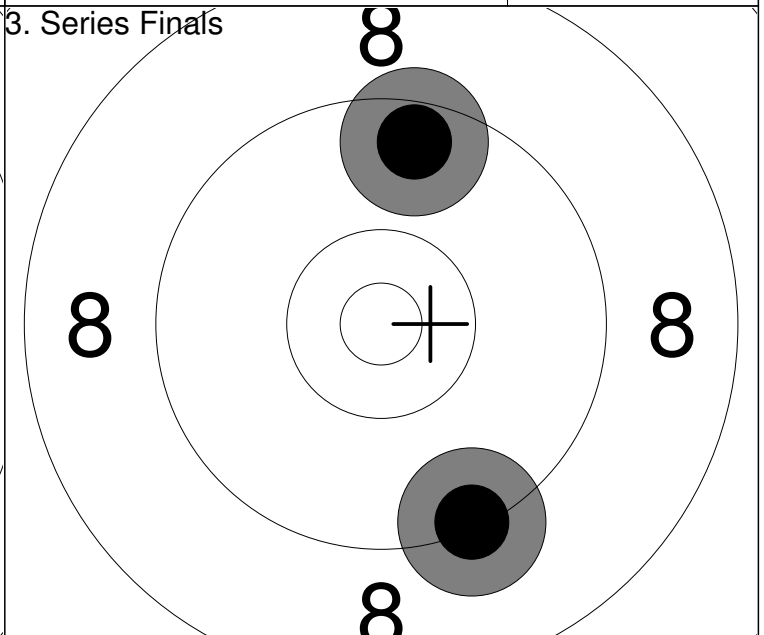
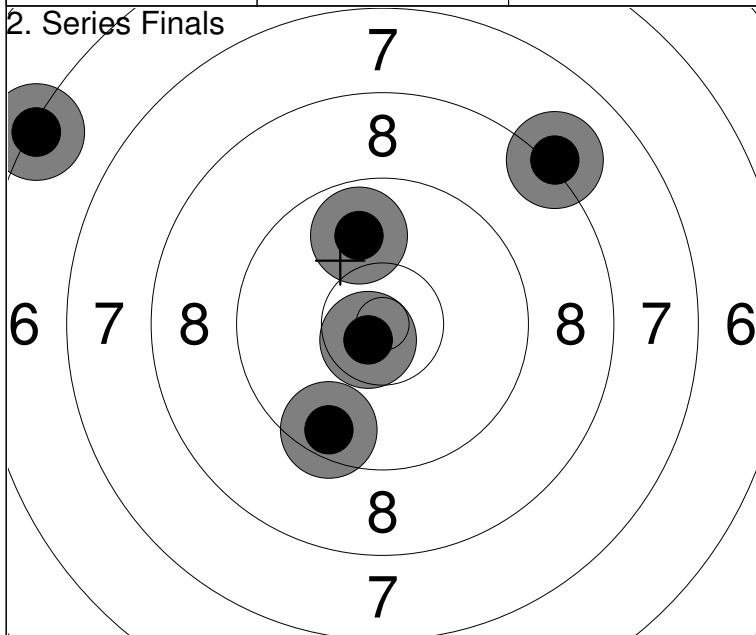

1: 9.9 ↑	Series 44.7
2: 6.3 ↙	
3: 9.6 ↘	93.0
4: 8.2 ↗	
5: 10.7x ↙	

1: 9.3 ↘	Series 18.8
2: 9.5 ↑	
	111.8

Relay 1	Lane 19	KOZIC Igor
-------------------	-------------------	-------------------

2023 SFC Pistol Nationals	ON	F	MP
---------------------------	----	---	----

16.07.2023	2023 PN AP60M Finals	Alberta Handgun Association
------------	----------------------	-----------------------------

Comment	Signature
---------	-----------

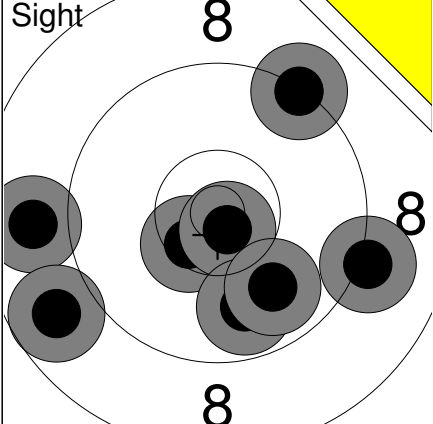
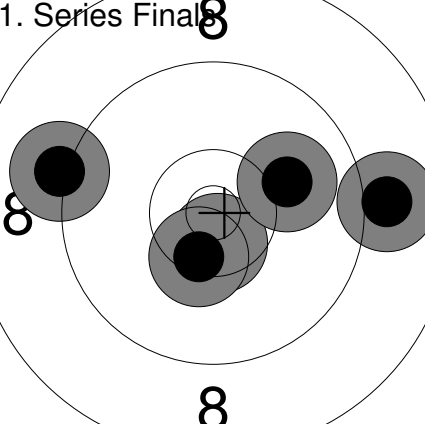
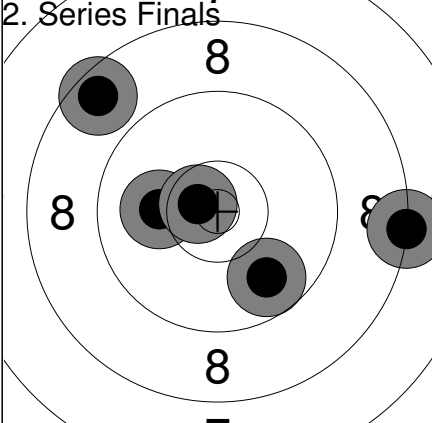
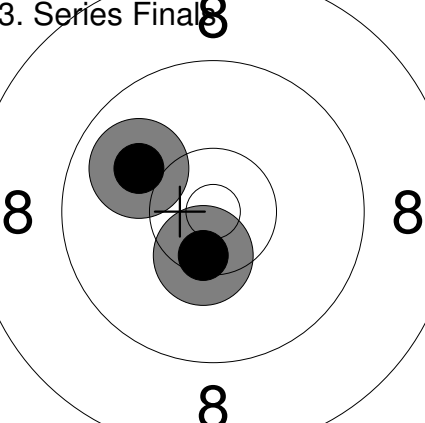
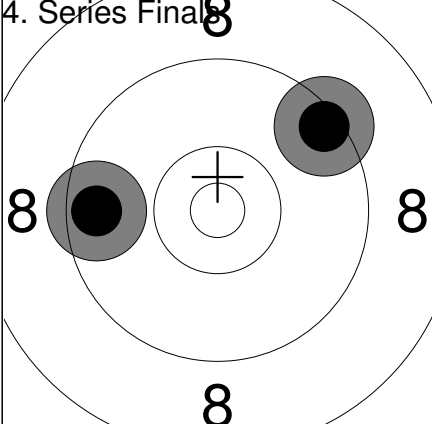
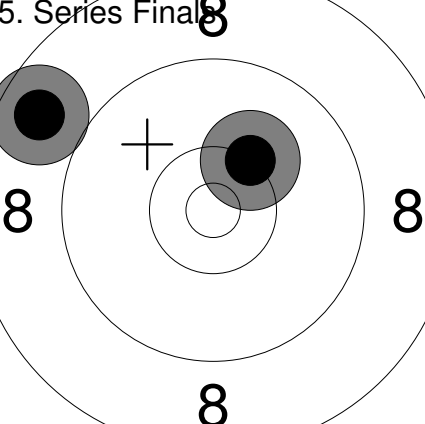
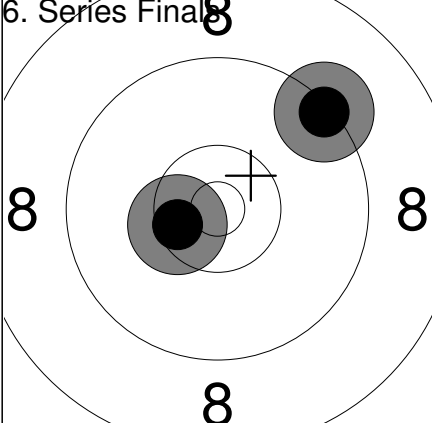
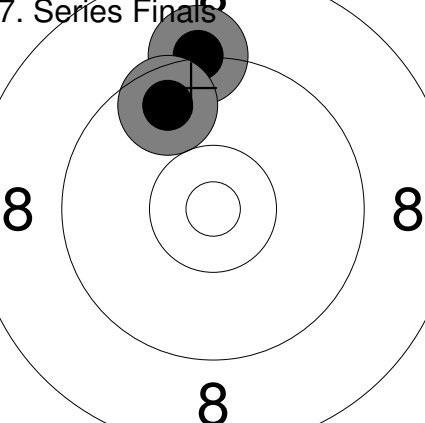
<p>Sight</p> 	<p>1: 10.5x ↙ 2: 8.8 ← 3: 10.7x ↘ 4: 9.8 ↘ 5: 9.9 ↘ 6: 8.8 ← 7: 9.3 ↗ 8: 9.1 ↘</p>	<p>1. Series Finals</p> 	<p>1: 9.1 ← 2: 10.6x ↓ 3: 9.0 → 4: 10.0 ↗ 5: 10.4x ↓</p>
	Series 76.9		Series 49.1
	0.0		49.1
<p>2. Series Finals</p> 	<p>1: 10.1 ← 2: 9.8 ↘ 3: 10.6x ↗ 4: 8.6 ↗ 5: 8.2 ↓</p>	<p>3. Series Finals</p> 	<p>1: 10.4x ↓ 2: 10.0 ←</p>
	Series 47.3		Series 20.4
	96.4		116.8
<p>4. Series Finals</p> 	<p>1: 9.4 ↗ 2: 9.6 ←</p>	<p>5. Series Finals</p> 	<p>1: 10.2 ↗ 2: 8.7 ←</p>
	Series 19.0		Series 18.9
	135.8		154.7
<p>6. Series Finals</p> 	<p>1: 10.5x ← 2: 9.3 ↗</p>	<p>7. Series Finals</p> 	<p>1: 9.2 ↑ 2: 9.7 ↗</p>
	Series 19.8		Series 18.9
	174.5		193.4