

Relay <b>1</b>	Lane <b>1</b>	<h1>HAGLUND Wayne</h1>
-------------------	------------------	------------------------

2023 SFC Pistol Nationals AB	SP	MP
------------------------------	----	----

15.07.2023	PN23AP-Q-1	Alberta Handgun Association
------------	------------	-----------------------------

Comment	Signature
---------	-----------

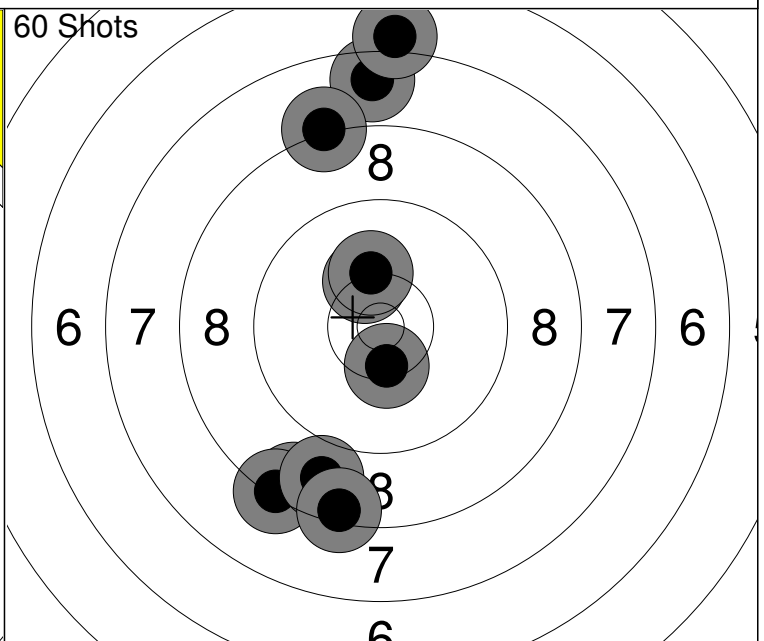
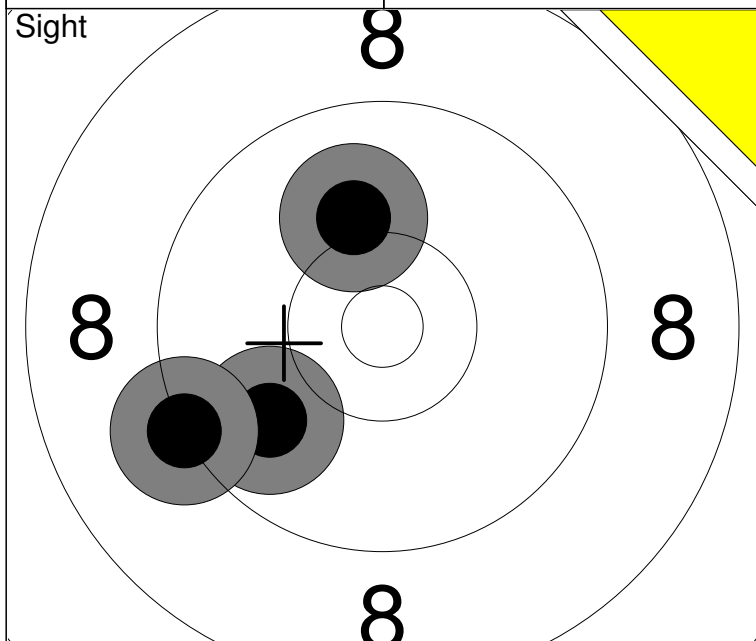

1: 9.8 ↙	Series	28 ( 0x)
2: 9.2 ↙		
3: 10.1 ↑		
		0 ( 0x)

1: 8.5 ↘	6: 8.2 ↑	Series	84 ( 1x)
2: 8.3 ↘	7: 10.2 ↑		
3: 8.8 ↘	8: 8.4 ↘		
4: 7.6 ↑	9: 7.0 ↑		
5: 10.3 ↑	10: 10.4x ↘	84 ( 1x)	

1: 8.5 ↘	6: 8.2 ↑	Series	84 ( 1x)
2: 8.3 ↘	7: 10.2 ↑		
3: 8.8 ↘	8: 8.4 ↘		
4: 7.6 ↑	9: 7.0 ↑		
5: 10.3 ↑	10: 10.4x ↘	84 ( 1x)	

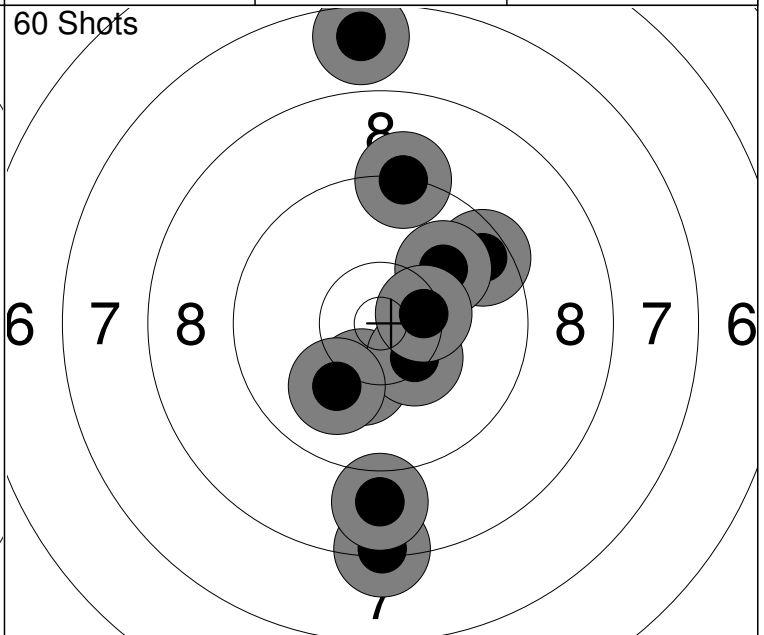
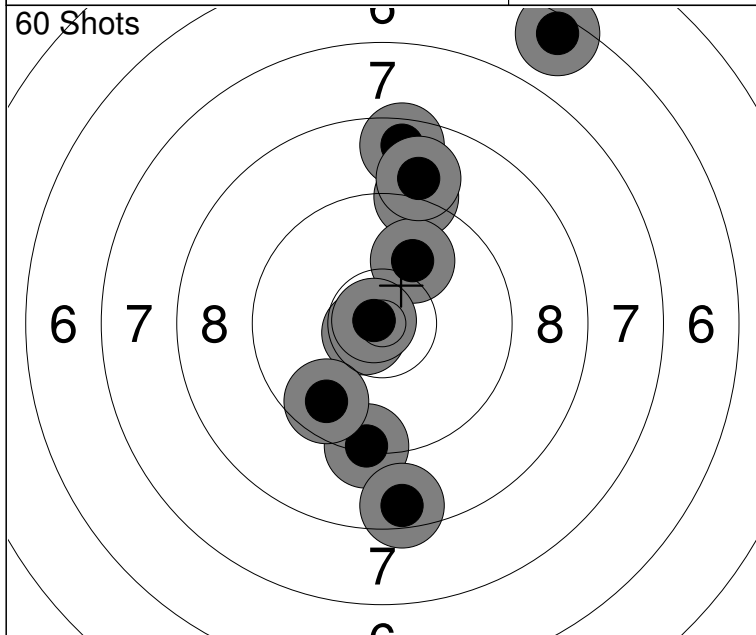

11: 9.2 ↑	16: 9.0 ↑	Series	88 ( 2x)
12: 9.3 ↓	17: 10.7x ↙		
13: 6.5 ↗	18: 9.7 ↘		
14: 8.6 ↑	19: 8.5 ↓		
15: 10.0 ↗	20: 10.8x ↙	172 ( 3x)	

21: 9.5 ↗	26: 10.0 ↗	Series	91 ( 2x)
22: 9.2 ↑	27: 10.4x ↘		
23: 7.6 ↑	28: 8.9 ↓		
24: 8.3 ↓	29: 10.4x →		
25: 10.3 ↓	30: 10.1 ↘	263 ( 5x)	

21: 9.5 ↗	26: 10.0 ↗	Series	91 ( 2x)
22: 9.2 ↑	27: 10.4x ↘		
23: 7.6 ↑	28: 8.9 ↓		
24: 8.3 ↓	29: 10.4x →		
25: 10.3 ↓	30: 10.1 ↘	263 ( 5x)	

<b>Relay</b> 1	<b>Lane</b> 2	<b>ZHOU Mo</b>
-------------------	------------------	----------------

2023 SFC Pistol Nationals	BC	SJ	MP
---------------------------	----	----	----

15.07.2023	PN23AP-Q-1	Alberta Handgun Association	
------------	------------	-----------------------------	--

Comment	Signature		
---------	-----------	--	--

<p><b>Sight</b></p>	<p>1: 10.0 ↘ 2: 7.6 ↑ 3: 9.7 ↓ 4: 9.9 ↓ 5: 10.4x ↓ 6: 8.7 → 7: 10.3 → 8: 9.5 ↑ 9: 8.9 ↓ 10: 5.6 ↗</p> <p>Series 85 (1x) 0 (0x)</p>	<p><b>Sight</b></p>	<p>11: 9.0 ↖ 12: 8.2 ↗ 13: 10.0 ↑ 14: 8.2 ↖ 15: 9.1 ↗</p> <p>Series 44 (0x) 0 (0x)</p>
<p><b>60 Shots</b></p>	<p>1: 7.9 ↑ 2: 10.4x ↑ 3: 9.4 ↑ 4: 9.7 ← 5: 8.3 ↑ 6: 8.6 ↑ 7: 9.6 ↓ 8: 9.4 ← 9: 8.6 ↓ 10: 8.9 ↙</p> <p>Series 85 (1x) 85 (1x)</p>	<p><b>60 Shots</b></p>	<p>11: 9.4 ↘ 12: 9.5 ↓ 13: 10.7x ↑ 14: 8.0 ↗ 15: 8.4 ↙ 16: 10.0 ↓ 17: 10.1 → 18: 10.7x ↖ 19: 9.5 ↖ 20: 8.1 →</p> <p>Series 91 (2x) 176 (3x)</p>
<p><b>60 Shots</b></p>	<p>21: 9.0 ↓ 22: 5.5 ↗ 23: 7.9 ↓ 24: 9.2 ↗ 25: 8.5 ↓ 26: 7.1 ↑ 27: 9.4 ↑ 28: 9.8 ← 29: 10.6x ↓ 30: 10.5x ↓</p> <p>Series 83 (2x) 259 (5x)</p>	<p><b>60 Shots</b></p>	<p>31: 9.2 ↗ 32: 9.0 ↗ 33: 6.0 ↗ 34: 10.1 ↗ 35: 9.7 → 36: 9.2 ↖ 37: 8.1 ↖ 38: 9.3 ← 39: 8.5 ↘ 40: 8.0 ↓</p> <p>Series 85 (0x) 344 (5x)</p>
<p><b>60 Shots</b></p>	<p>41: 9.2 → 42: 10.3 ↘ 43: 10.6x ↑ 44: 9.9 ↓ 45: 8.5 → 46: 8.0 ↑ 47: 7.4 ↑ 48: 10.1 ↗ 49: 10.0 ↗ 50: 9.7 ↘</p> <p>Series 90 (1x) 434 (6x)</p>	<p><b>60 Shots</b></p>	<p>51: 9.8 → 52: 9.4 ↓ 53: 7.5 ↑ 54: 9.9 ↖ 55: 9.7 ↖ 56: 8.7 ↗ 57: 9.8 ↘ 58: 9.2 ↑ 59: 8.9 ← 60: 8.3 ↑</p> <p>Series 85 (0x) 519 (6x)</p>

Relay **1** Lane **3** **NORMAN Rex**

2023 SFC Pistol Nationals SK JR MP

15.07.2023 PN23AP-Q-1 Alberta Handgun Association

Comment Signature

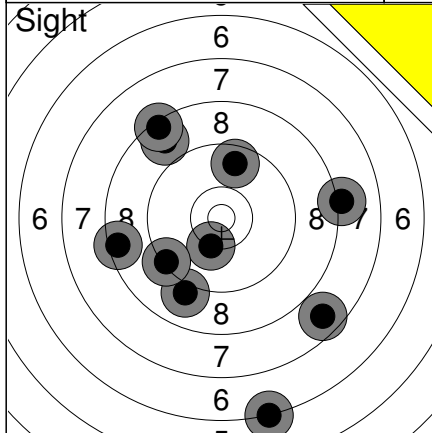

1:	8.7	↗
2:	10.2	↓
3:	9.0	↓
4:	8.5	←
5:	7.7	↓
6:	8.4	↗
7:	6.2	↓
8:	9.3	←
9:	9.6	↑
10:	8.1	→
Series	82 (0x)	
	0 (0x)	

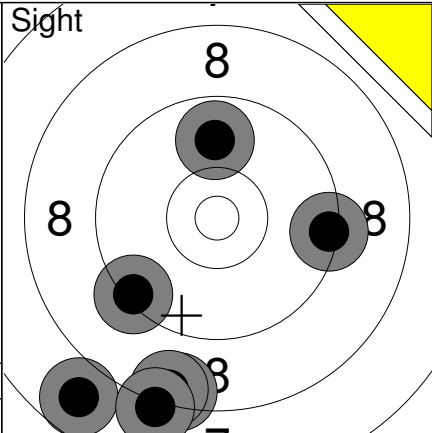

11:	8.4	↓
12:	7.8	↙
13:	9.4	→
14:	8.4	↓
15:	9.4	↙
16:	9.9	↑
17:	8.1	↓
Series	58 (0x)	
	0 (0x)	

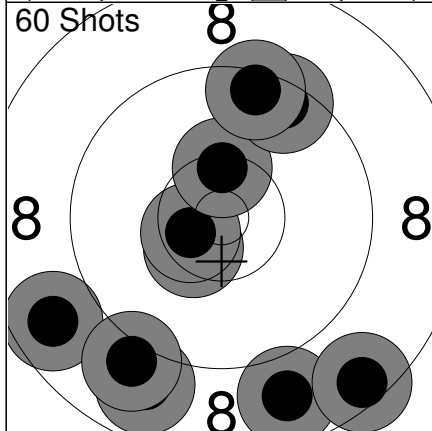

1:	8.8	↓
2:	10.5x	↙
3:	8.7	←
4:	10.6x	←
5:	8.9	↓
6:	9.0	↓
7:	10.4x	↑
8:	8.5	↓
9:	9.5	↗
10:	9.4	↑
Series	89 (3x)	
	89 (3x)	

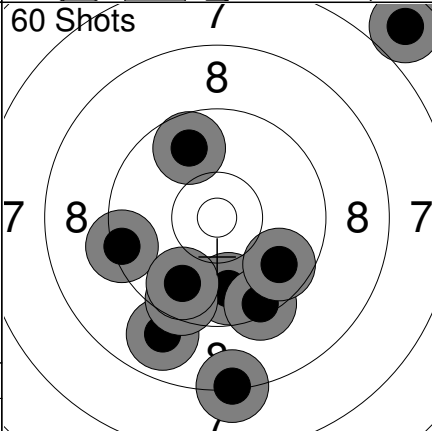

11:	9.8	↓
12:	8.9	↙
13:	9.4	↓
14:	8.3	↓
15:	6.7	↗
16:	9.8	↑
17:	9.5	↓
18:	9.4	←
19:	9.7	↘
20:	9.8	↓
Series	85 (0x)	
	174 (3x)	

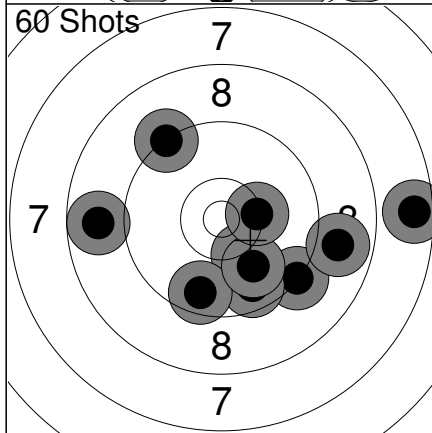

21:	10.2	↓
22:	8.8	←
23:	9.3	↘
24:	9.3	↗
25:	9.7	↓
26:	9.6	↙
27:	10.0	↓
28:	8.9	→
29:	7.6	→
30:	10.3	→
Series	89 (0x)	
	263 (3x)	

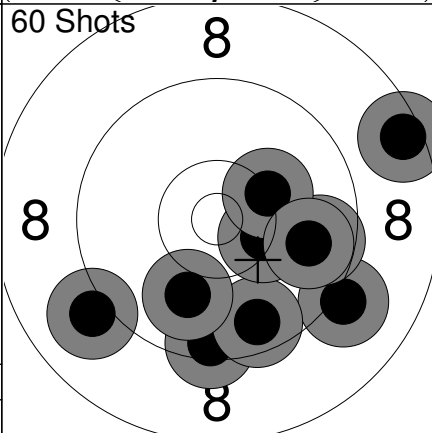

31:	9.1	↘
32:	9.4	↓
33:	9.6	↓
34:	8.5	→
35:	9.7	→
36:	10.3	→
37:	10.3	→
38:	9.0	←
39:	9.8	→
40:	10.0	↓
Series	92 (0x)	
	355 (3x)	

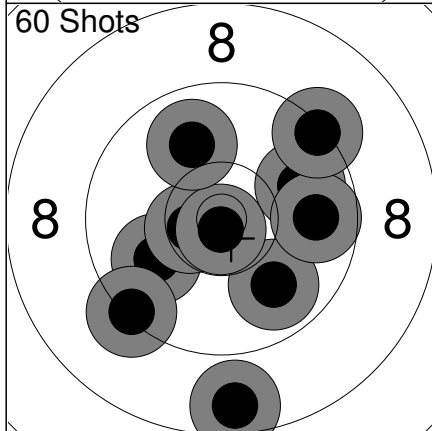

41:	8.6	↓
42:	10.0	←
43:	9.9	↓
44:	10.5x	←
45:	10.8x	↓
46:	9.3	↙
47:	9.9	→
48:	9.8	→
49:	9.9	↑
50:	9.3	↗
Series	92 (2x)	
	447 (5x)	

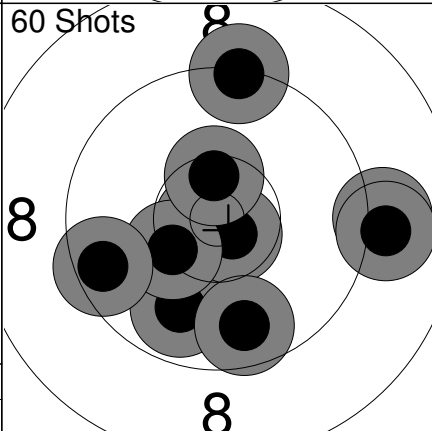

51:	9.9	↓
52:	10.8x	←
53:	10.7x	↘
54:	9.1	→
55:	10.3	↙
56:	9.7	↓
57:	9.3	↑
58:	9.0	→
59:	10.5x	↑
60:	9.5	←
Series	94 (3x)	
	541 (8x)	

<b>Relay</b> <b>1</b>	<b>Lane</b> <b>4</b>	<b>NADON William</b>
--------------------------	-------------------------	----------------------

2023 SFC Pistol Nationals	QC	JR	MP
---------------------------	----	----	----

15.07.2023	PN23AP-Q-1	Alberta Handgun Association
------------	------------	-----------------------------

Comment	Signature
---------	-----------

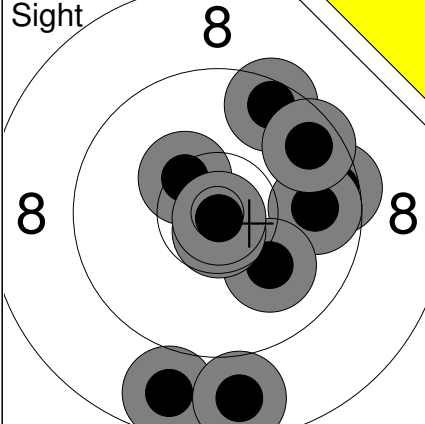
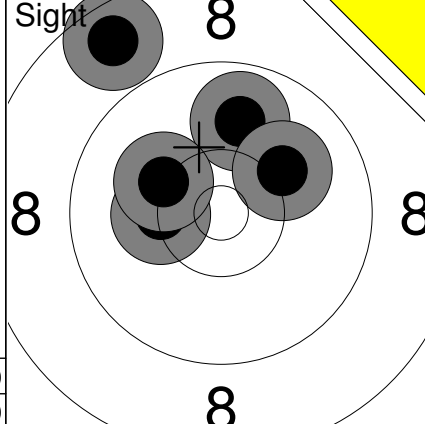
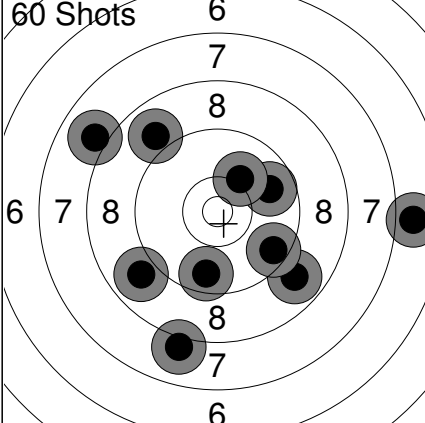
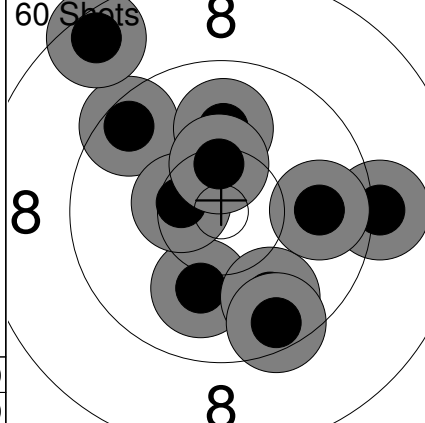
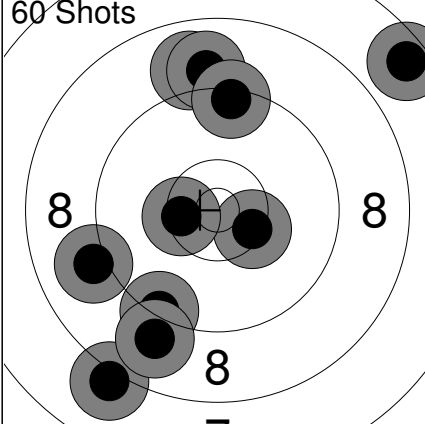
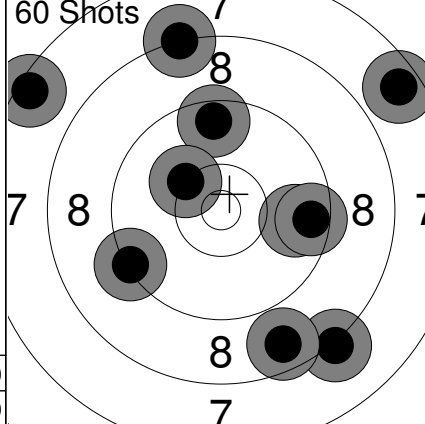
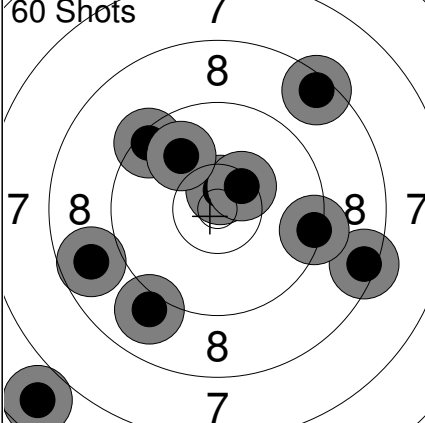
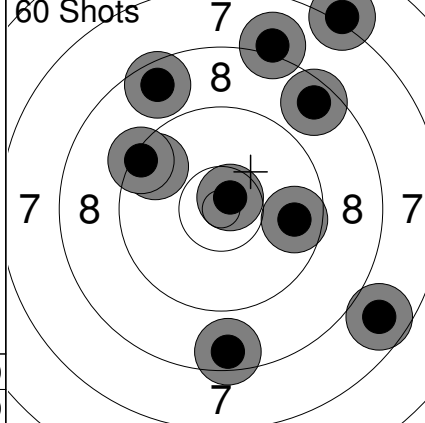
<p><b>Sight</b></p> 	<table border="1" style="width:100%; border-collapse: collapse;"> <tr><td>1:</td><td>9.5</td><td>↗</td></tr> <tr><td>2:</td><td>10.4x</td><td>↗</td></tr> <tr><td>3:</td><td>9.5</td><td>→</td></tr> <tr><td>4:</td><td>9.8</td><td>→</td></tr> <tr><td>5:</td><td>9.6</td><td>↗</td></tr> <tr><td>6:</td><td>10.1</td><td>↘</td></tr> <tr><td>7:</td><td>8.7</td><td>↘</td></tr> <tr><td>8:</td><td>10.7x</td><td>↘</td></tr> <tr><td>9:</td><td>8.7</td><td>↘</td></tr> <tr><td>10:</td><td>10.9x</td><td>↘</td></tr> <tr><td colspan="2"><b>Series</b></td><td><b>92 (3x)</b></td></tr> <tr><td colspan="2"></td><td><b>0 (0x)</b></td></tr> </table>	1:	9.5	↗	2:	10.4x	↗	3:	9.5	→	4:	9.8	→	5:	9.6	↗	6:	10.1	↘	7:	8.7	↘	8:	10.7x	↘	9:	8.7	↘	10:	10.9x	↘	<b>Series</b>		<b>92 (3x)</b>			<b>0 (0x)</b>	<p><b>Sight</b></p> 	<table border="1" style="width:100%; border-collapse: collapse;"> <tr><td>11:</td><td>9.9</td><td>↗</td></tr> <tr><td>12:</td><td>10.3</td><td>←</td></tr> <tr><td>13:</td><td>10.2</td><td>↖</td></tr> <tr><td>14:</td><td>8.6</td><td>↗</td></tr> <tr><td>15:</td><td>10.1</td><td>↗</td></tr> <tr><td colspan="2"><b>Series</b></td><td><b>47 (0x)</b></td></tr> <tr><td colspan="2"></td><td><b>0 (0x)</b></td></tr> </table>	11:	9.9	↗	12:	10.3	←	13:	10.2	↖	14:	8.6	↗	15:	10.1	↗	<b>Series</b>		<b>47 (0x)</b>			<b>0 (0x)</b>															
1:	9.5	↗																																																																									
2:	10.4x	↗																																																																									
3:	9.5	→																																																																									
4:	9.8	→																																																																									
5:	9.6	↗																																																																									
6:	10.1	↘																																																																									
7:	8.7	↘																																																																									
8:	10.7x	↘																																																																									
9:	8.7	↘																																																																									
10:	10.9x	↘																																																																									
<b>Series</b>		<b>92 (3x)</b>																																																																									
		<b>0 (0x)</b>																																																																									
11:	9.9	↗																																																																									
12:	10.3	←																																																																									
13:	10.2	↖																																																																									
14:	8.6	↗																																																																									
15:	10.1	↗																																																																									
<b>Series</b>		<b>47 (0x)</b>																																																																									
		<b>0 (0x)</b>																																																																									
<p><b>60 Shots</b></p> 	<table border="1" style="width:100%; border-collapse: collapse;"> <tr><td>1:</td><td>9.8</td><td>→</td></tr> <tr><td>2:</td><td>8.0</td><td>↗</td></tr> <tr><td>3:</td><td>8.9</td><td>↖</td></tr> <tr><td>4:</td><td>6.9</td><td>→</td></tr> <tr><td>5:</td><td>9.6</td><td>↘</td></tr> <tr><td>6:</td><td>8.9</td><td>↘</td></tr> <tr><td>7:</td><td>8.9</td><td>↗</td></tr> <tr><td>8:</td><td>10.1</td><td>↗</td></tr> <tr><td>9:</td><td>8.0</td><td>↘</td></tr> <tr><td>10:</td><td>9.5</td><td>↘</td></tr> <tr><td colspan="2"><b>Series</b></td><td><b>83 (0x)</b></td></tr> <tr><td colspan="2"></td><td><b>83 (0x)</b></td></tr> </table>	1:	9.8	→	2:	8.0	↗	3:	8.9	↖	4:	6.9	→	5:	9.6	↘	6:	8.9	↘	7:	8.9	↗	8:	10.1	↗	9:	8.0	↘	10:	9.5	↘	<b>Series</b>		<b>83 (0x)</b>			<b>83 (0x)</b>	<p><b>60 Shots</b></p> 	<table border="1" style="width:100%; border-collapse: collapse;"> <tr><td>11:</td><td>9.1</td><td>→</td></tr> <tr><td>12:</td><td>10.1</td><td>↘</td></tr> <tr><td>13:</td><td>9.5</td><td>↗</td></tr> <tr><td>14:</td><td>10.5x</td><td>←</td></tr> <tr><td>15:</td><td>9.8</td><td>↘</td></tr> <tr><td>16:</td><td>9.5</td><td>↘</td></tr> <tr><td>17:</td><td>10.0</td><td>↗</td></tr> <tr><td>18:</td><td>8.5</td><td>↗</td></tr> <tr><td>19:</td><td>9.8</td><td>→</td></tr> <tr><td>20:</td><td>10.4x</td><td>↗</td></tr> <tr><td colspan="2"><b>Series</b></td><td><b>93 (2x)</b></td></tr> <tr><td colspan="2"></td><td><b>176 (2x)</b></td></tr> </table>	11:	9.1	→	12:	10.1	↘	13:	9.5	↗	14:	10.5x	←	15:	9.8	↘	16:	9.5	↘	17:	10.0	↗	18:	8.5	↗	19:	9.8	→	20:	10.4x	↗	<b>Series</b>		<b>93 (2x)</b>			<b>176 (2x)</b>
1:	9.8	→																																																																									
2:	8.0	↗																																																																									
3:	8.9	↖																																																																									
4:	6.9	→																																																																									
5:	9.6	↘																																																																									
6:	8.9	↘																																																																									
7:	8.9	↗																																																																									
8:	10.1	↗																																																																									
9:	8.0	↘																																																																									
10:	9.5	↘																																																																									
<b>Series</b>		<b>83 (0x)</b>																																																																									
		<b>83 (0x)</b>																																																																									
11:	9.1	→																																																																									
12:	10.1	↘																																																																									
13:	9.5	↗																																																																									
14:	10.5x	←																																																																									
15:	9.8	↘																																																																									
16:	9.5	↘																																																																									
17:	10.0	↗																																																																									
18:	8.5	↗																																																																									
19:	9.8	→																																																																									
20:	10.4x	↗																																																																									
<b>Series</b>		<b>93 (2x)</b>																																																																									
		<b>176 (2x)</b>																																																																									
<p><b>60 Shots</b></p> 	<table border="1" style="width:100%; border-collapse: collapse;"> <tr><td>21:</td><td>8.9</td><td>↗</td></tr> <tr><td>22:</td><td>9.0</td><td>←</td></tr> <tr><td>23:</td><td>7.5</td><td>↗</td></tr> <tr><td>24:</td><td>9.0</td><td>↗</td></tr> <tr><td>25:</td><td>9.4</td><td>↗</td></tr> <tr><td>26:</td><td>10.4x</td><td>→</td></tr> <tr><td>27:</td><td>8.1</td><td>↘</td></tr> <tr><td>28:</td><td>9.3</td><td>↘</td></tr> <tr><td>29:</td><td>8.9</td><td>↘</td></tr> <tr><td>30:</td><td>10.4x</td><td>←</td></tr> <tr><td colspan="2"><b>Series</b></td><td><b>87 (2x)</b></td></tr> <tr><td colspan="2"></td><td><b>263 (4x)</b></td></tr> </table>	21:	8.9	↗	22:	9.0	←	23:	7.5	↗	24:	9.0	↗	25:	9.4	↗	26:	10.4x	→	27:	8.1	↘	28:	9.3	↘	29:	8.9	↘	30:	10.4x	←	<b>Series</b>		<b>87 (2x)</b>			<b>263 (4x)</b>	<p><b>60 Shots</b></p> 	<table border="1" style="width:100%; border-collapse: collapse;"> <tr><td>31:</td><td>9.6</td><td>↗</td></tr> <tr><td>32:</td><td>8.2</td><td>↘</td></tr> <tr><td>33:</td><td>9.8</td><td>→</td></tr> <tr><td>34:</td><td>8.6</td><td>↘</td></tr> <tr><td>35:</td><td>9.5</td><td>→</td></tr> <tr><td>36:</td><td>8.2</td><td>↗</td></tr> <tr><td>37:</td><td>7.6</td><td>↗</td></tr> <tr><td>38:</td><td>10.2</td><td>↗</td></tr> <tr><td>39:</td><td>7.4</td><td>↖</td></tr> <tr><td>40:</td><td>9.3</td><td>↖</td></tr> <tr><td colspan="2"><b>Series</b></td><td><b>84 (0x)</b></td></tr> <tr><td colspan="2"></td><td><b>347 (4x)</b></td></tr> </table>	31:	9.6	↗	32:	8.2	↘	33:	9.8	→	34:	8.6	↘	35:	9.5	→	36:	8.2	↗	37:	7.6	↗	38:	10.2	↗	39:	7.4	↖	40:	9.3	↖	<b>Series</b>		<b>84 (0x)</b>			<b>347 (4x)</b>
21:	8.9	↗																																																																									
22:	9.0	←																																																																									
23:	7.5	↗																																																																									
24:	9.0	↗																																																																									
25:	9.4	↗																																																																									
26:	10.4x	→																																																																									
27:	8.1	↘																																																																									
28:	9.3	↘																																																																									
29:	8.9	↘																																																																									
30:	10.4x	←																																																																									
<b>Series</b>		<b>87 (2x)</b>																																																																									
		<b>263 (4x)</b>																																																																									
31:	9.6	↗																																																																									
32:	8.2	↘																																																																									
33:	9.8	→																																																																									
34:	8.6	↘																																																																									
35:	9.5	→																																																																									
36:	8.2	↗																																																																									
37:	7.6	↗																																																																									
38:	10.2	↗																																																																									
39:	7.4	↖																																																																									
40:	9.3	↖																																																																									
<b>Series</b>		<b>84 (0x)</b>																																																																									
		<b>347 (4x)</b>																																																																									
<p><b>60 Shots</b></p> 	<table border="1" style="width:100%; border-collapse: collapse;"> <tr><td>41:</td><td>10.6x</td><td>↗</td></tr> <tr><td>42:</td><td>8.5</td><td>↗</td></tr> <tr><td>43:</td><td>8.4</td><td>→</td></tr> <tr><td>44:</td><td>10.4x</td><td>↗</td></tr> <tr><td>45:</td><td>6.7</td><td>↖</td></tr> <tr><td>46:</td><td>9.0</td><td>↖</td></tr> <tr><td>47:</td><td>9.4</td><td>↗</td></tr> <tr><td>48:</td><td>9.4</td><td>→</td></tr> <tr><td>49:</td><td>9.9</td><td>↗</td></tr> <tr><td>50:</td><td>8.7</td><td>←</td></tr> <tr><td colspan="2"><b>Series</b></td><td><b>86 (2x)</b></td></tr> <tr><td colspan="2"></td><td><b>433 (6x)</b></td></tr> </table>	41:	10.6x	↗	42:	8.5	↗	43:	8.4	→	44:	10.4x	↗	45:	6.7	↖	46:	9.0	↖	47:	9.4	↗	48:	9.4	→	49:	9.9	↗	50:	8.7	←	<b>Series</b>		<b>86 (2x)</b>			<b>433 (6x)</b>	<p><b>60 Shots</b></p> 	<table border="1" style="width:100%; border-collapse: collapse;"> <tr><td>51:</td><td>8.6</td><td>↗</td></tr> <tr><td>52:</td><td>9.6</td><td>↖</td></tr> <tr><td>53:</td><td>9.7</td><td>→</td></tr> <tr><td>54:</td><td>9.4</td><td>↖</td></tr> <tr><td>55:</td><td>8.6</td><td>↗</td></tr> <tr><td>56:</td><td>8.1</td><td>↗</td></tr> <tr><td>57:</td><td>7.1</td><td>↗</td></tr> <tr><td>58:</td><td>8.5</td><td>↘</td></tr> <tr><td>59:</td><td>7.7</td><td>↘</td></tr> <tr><td>60:</td><td>10.7x</td><td>↗</td></tr> <tr><td colspan="2"><b>Series</b></td><td><b>83 (1x)</b></td></tr> <tr><td colspan="2"></td><td><b>516 (7x)</b></td></tr> </table>	51:	8.6	↗	52:	9.6	↖	53:	9.7	→	54:	9.4	↖	55:	8.6	↗	56:	8.1	↗	57:	7.1	↗	58:	8.5	↘	59:	7.7	↘	60:	10.7x	↗	<b>Series</b>		<b>83 (1x)</b>			<b>516 (7x)</b>
41:	10.6x	↗																																																																									
42:	8.5	↗																																																																									
43:	8.4	→																																																																									
44:	10.4x	↗																																																																									
45:	6.7	↖																																																																									
46:	9.0	↖																																																																									
47:	9.4	↗																																																																									
48:	9.4	→																																																																									
49:	9.9	↗																																																																									
50:	8.7	←																																																																									
<b>Series</b>		<b>86 (2x)</b>																																																																									
		<b>433 (6x)</b>																																																																									
51:	8.6	↗																																																																									
52:	9.6	↖																																																																									
53:	9.7	→																																																																									
54:	9.4	↖																																																																									
55:	8.6	↗																																																																									
56:	8.1	↗																																																																									
57:	7.1	↗																																																																									
58:	8.5	↘																																																																									
59:	7.7	↘																																																																									
60:	10.7x	↗																																																																									
<b>Series</b>		<b>83 (1x)</b>																																																																									
		<b>516 (7x)</b>																																																																									

Relay **1** Lane **5** **WANG Hejia**

2023 SFC Pistol Nationals BC JR MP

15.07.2023 PN23AP-Q-1 Alberta Handgun Association

Comment Signature

	1: 8.8 ↓ 2: 9.9 ↗ 3: 8.5 ← 4: 9.7 ↓ 5: 9.7 ↑ 6: 10.3 ↑ 7: 10.0 ↑ 8: 9.6 → 9: 9.9 → 10: 10.5x ↓		11: 9.9 ↗ 12: 10.1 ← 13: 8.7 ↗ 14: 8.8 ↗ 15: 10.4x ↓
	Series 91 (1x) 0 (0x)		Series 45 (1x) 0 (0x)
	1: 9.4 ↓ 2: 10.0 → 3: 8.8 → 4: 9.4 ↑ 5: 7.9 ↑ 6: 10.7x ← 7: 8.2 ↑ 8: 8.9 ↗ 9: 8.5 → 10: 8.4 ↗		11: 9.0 ↗ 12: 8.8 ↗ 13: 8.6 → 14: 10.1 ↓ 15: 10.0 ↓ 16: 10.2 ↗ 17: 9.8 ↓ 18: 9.4 ↗ 19: 9.9 ↗ 20: 9.4 ↗
	Series 85 (1x) 85 (1x)		Series 91 (0x) 176 (1x)
	21: 10.0 ↓ 22: 9.4 ↓ 23: 9.5 → 24: 9.9 ↑ 25: 9.8 → 26: 9.1 ← 27: 9.3 → 28: 10.2 ← 29: 9.5 → 30: 10.3 ←		31: 9.7 ← 32: 9.6 → 33: 8.9 ← 34: 9.9 ↓ 35: 10.6x ↓ 36: 9.8 ↓ 37: 8.9 ← 38: 9.3 ← 39: 8.3 ↗ 40: 9.2 ←
	Series 93 (0x) 269 (1x)		Series 88 (1x) 357 (2x)
	41: 9.5 ← 42: 9.4 ← 43: 8.6 ↗ 44: 9.2 → 45: 9.9 ← 46: 9.9 ↓ 47: 9.6 → 48: 9.2 ↗ 49: 9.3 ↑ 50: 9.3 ↑		51: 10.3 ↓ 52: 9.4 ↑ 53: 8.9 ↓ 54: 9.9 ← 55: 10.7x ↗ 56: 9.7 ↗ 57: 8.1 ↓ 58: 10.4x ↗ 59: 10.0 → 60: 9.8 ←
	Series 89 (0x) 446 (2x)		Series 92 (2x) 538 (4x)

Relay **1** Lane **6** **NORMAN Seth**

2023 SFC Pistol Nationals SK IJ MP

15.07.2023 PN23AP-Q-1 Alberta Handgun Association

Comment Signature

	1: 9.0 ↑ 2: 8.1 ← 3: 9.9 ↑ 4: 10.0 ← 5: 9.2 ↓ 6: 9.8 ↑		1: 10.1 ↑ 2: 10.5x ↗ 3: 9.5 → 4: 10.5x ← 5: 8.4 ↗ 6: 9.4 ↘ 7: 9.3 ↓ 8: 9.7 ↓ 9: 9.2 → 10: 9.2 ↓
	Series 54 (0x) 0 (0x)		Series 92 (2x) 92 (2x)

	11: 9.6 → 12: 8.6 ↓ 13: 10.2 ↓ 14: 8.6 → 15: 9.4 ↓ 16: 9.6 → 17: 9.3 ↓ 18: 10.4x → 19: 8.1 ↓ 20: 9.4 ↓		21: 9.4 ↘ 22: 10.1 → 23: 8.3 ↗ 24: 10.0 ↘ 25: 9.9 ↓ 26: 9.7 ↓ 27: 9.9 ← 28: 9.9 ↘ 29: 9.2 ↘ 30: 7.7 →
	Series 89 (1x) 181 (3x)		Series 89 (0x) 270 (3x)

	31: 5.5 ↑ 32: 10.4x ↓ 33: 9.6 ↓ 34: 10.5x ↗ 35: 10.0 ↓ 36: 8.5 ↗ 37: 10.5x ↘ 38: 9.9 ↓ 39: 10.2 ↓ 40: 10.5x →		41: 10.5x ↗ 42: 9.6 ↗ 43: 10.0 ↓ 44: 10.2 ↓ 45: 10.2 ↓ 46: 8.8 ↓ 47: 9.2 ↓ 48: 9.8 ← 49: 10.4x ↓ 50: 10.0 ↓
	Series 91 (4x) 361 (7x)		Series 95 (2x) 456 (9x)

	51: 8.6 ↓ 52: 9.3 ↓ 53: 9.8 → 54: 10.4x ↓ 55: 9.7 ↘ 56: 9.9 ← 57: 9.3 ↘ 58: 8.7 ↓ 59: 10.0 ↓ 60: 10.5x ↓	
	Series 91 (2x) 547 (11x)	



Relay **1** Lane **7** **TESSIER Jacques**

2023 SFC Pistol Nationals QC VT MP

15.07.2023 PN23AP-Q-1 Alberta Handgun Association

Comment Signature

	1: 5.7 ← 2: 7.1 ↗ 3: 7.9 ↓ 4: 7.4 → 5: 10.1 ↑ 6: 7.9 → 7: 9.6 ↓ 8: 7.6 → 9: 7.8 → 10: 8.5 ↓		1: 9.5 ↙ 2: 9.1 → 3: 10.2 ↓ 4: 9.6 ↘ 5: 7.9 ↓ 6: 9.0 ↓ 7: 7.1 ↖ 8: 9.4 ↘ 9: 10.1 ↙ 10: 9.4 ↗
	Series 74 (0x) 0 (0x)		Series 88 (0x) 88 (0x)

	11: 9.2 ← 12: 9.6 ← 13: 8.9 ↓ 14: 8.5 ← 15: 8.9 ← 16: 9.1 ↓ 17: 8.3 ↓ 18: 9.2 ← 19: 7.4 ↓ 20: 9.5 ↗		21: 7.7 ↙ 22: 8.8 ↓ 23: 9.8 → 24: 10.2 ↑ 25: 10.3 ↓ 26: 9.9 ↖ 27: 8.0 ↓ 28: 5.7 ↗ 29: 6.9 ↘ 30: 9.7 ↗
	Series 84 (0x) 172 (0x)		Series 81 (0x) 253 (0x)

	31: 10.7x → 32: 9.9 ↖ 33: 9.3 → 34: 9.5 ← 35: 8.3 ↓ 36: 7.5 ↓ 37: 10.2 ↓ 38: 8.5 ← 39: 8.5 ↑ 40: 9.0 ↑		41: 8.7 ↙ 42: 9.4 ↓ 43: 9.8 ↓ 44: 9.5 ← 45: 10.2 ↓ 46: 7.6 ↓ 47: 10.2 ↓ 48: 9.8 ↗ 49: 9.0 → 50: 7.6 →
	Series 87 (1x) 340 (1x)		Series 87 (0x) 427 (1x)

	51: 9.8 ↓ 52: 9.4 → 53: 10.9x ← 54: 8.9 ↑ 55: 10.4x ↖ 56: 9.1 ← 57: 7.6 ↓ 58: 8.3 ← 59: 10.2 → 60: 8.9 ↓		
	Series 88 (2x) 515 (3x)		

Relay **1** Lane **8** **POLAD HOSHERDAR**

2023 SFC Pistol Nationals NS VT MP

15.07.2023 PN23AP-Q-1 Alberta Handgun Association

Comment Signature

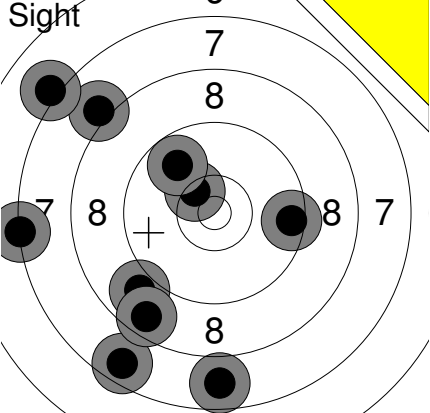
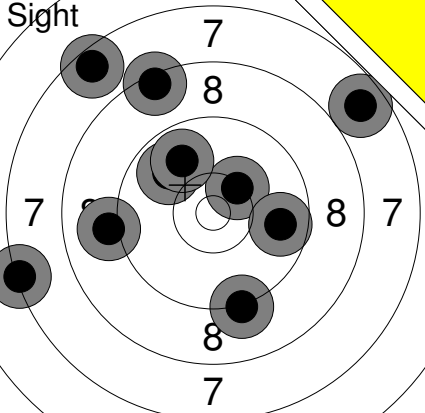
	1: 10.4x ↗ 2: 7.6 ↘ 3: 8.9 ↙ 4: 7.3 ← 5: 8.6 ↘ 6: 8.0 ↗ 7: 7.1 ↗ 8: 7.7 ↘ 9: 9.8 ↗ 10: 9.5 →		11: 9.2 ↓ 12: 10.3 ↗ 13: 9.1 ← 14: 9.7 → 15: 7.3 ← 16: 9.9 ↗ 17: 7.5 ↗ 18: 9.9 ↗ 19: 7.7 ↗ 20: 8.4 ↗
	Series 80 (1x) 0 (0x)		Series 84 (0x) 0 (0x)

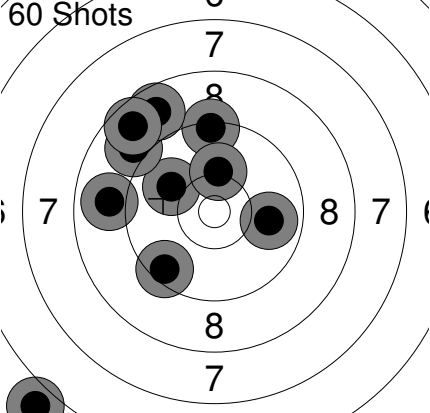
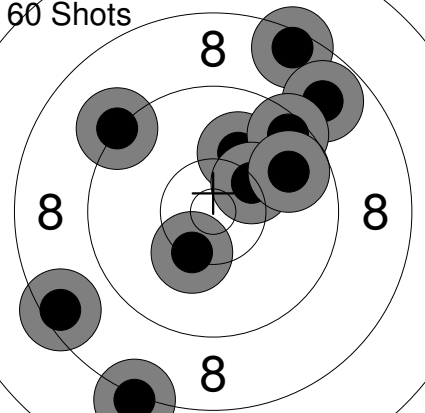
	1: 10.0 ↗ 2: 5.8 ↘ 3: 9.3 ↗ 4: 9.9 → 5: 9.5 ↘ 6: 8.9 ← 7: 9.0 ↗ 8: 10.2 ↗ 9: 8.7 ↗ 10: 8.7 ↗		11: 10.3 ↓ 12: 8.5 ← 13: 8.2 ↓ 14: 8.5 ↗ 15: 10.1 ↗ 16: 9.2 ↗ 17: 8.8 ↗ 18: 9.5 ↗ 19: 10.3 ↗ 20: 9.8 ↗
	Series 85 (0x) 85 (0x)		Series 89 (0x) 174 (0x)

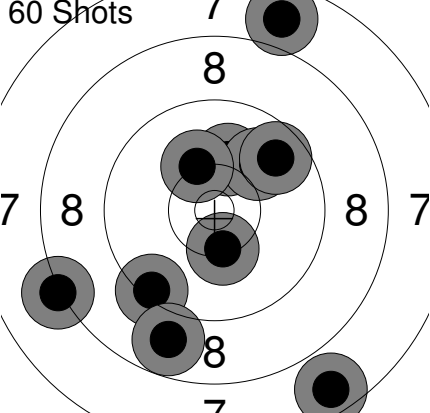
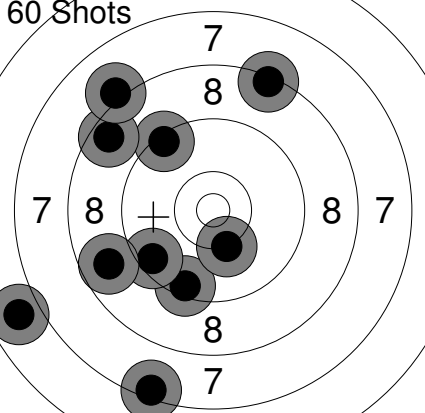
	21: 10.1 ↗ 22: 9.4 ↘ 23: 7.8 ↗ 24: 8.2 ← 25: 8.8 ↘ 26: 10.3 ↘ 27: 10.0 ↗ 28: 7.6 ↘ 29: 9.7 ↗ 30: 10.2 ↗		31: 9.4 ↓ 32: 7.4 ↓ 33: 8.3 ↗ 34: 9.4 ↗ 35: 8.6 ↗ 36: 10.2 ↓ 37: 9.5 ← 38: 8.8 ← 39: 8.1 ↗ 40: 6.8 ←
	Series 88 (0x) 262 (0x)		Series 82 (0x) 344 (0x)

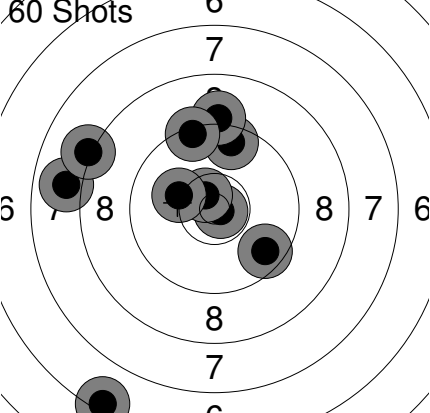
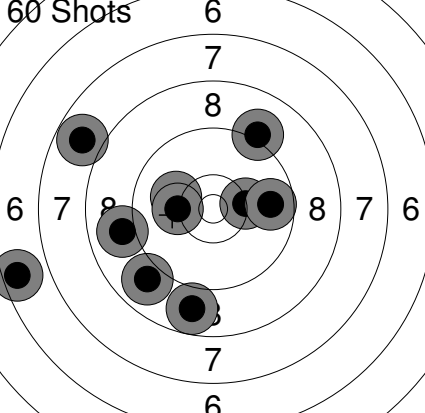
	41: 9.6 ↗ 42: 9.1 ↗ 43: 6.4 ↘ 44: 10.8x → 45: 9.6 ↘ 46: 9.4 ↗ 47: 10.6x ↗ 48: 7.9 ← 49: 10.2 ↗ 50: 8.2 ↗		51: 9.1 ↗ 52: 8.8 ↓ 53: 10.2 → 54: 7.8 ← 55: 8.9 ↘ 56: 9.7 → 57: 6.5 ← 58: 10.1 ← 59: 9.0 ← 60: 10.2 ←
	Series 87 (2x) 431 (2x)		Series 86 (0x) 517 (2x)



Relay **1** Lane **9** **KINDBOM Matt**

2023 SFC Pistol Nationals ON SS MP

15.07.2023 PN23AP-Q-1 Alberta Handgun Association

Comment Signature

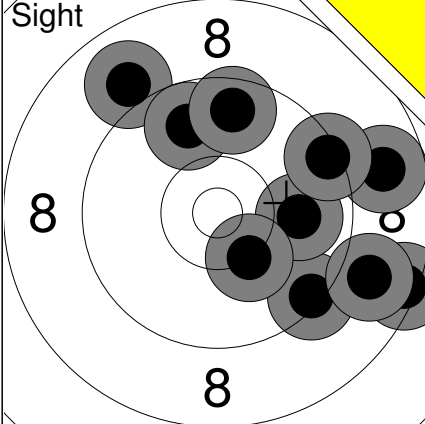
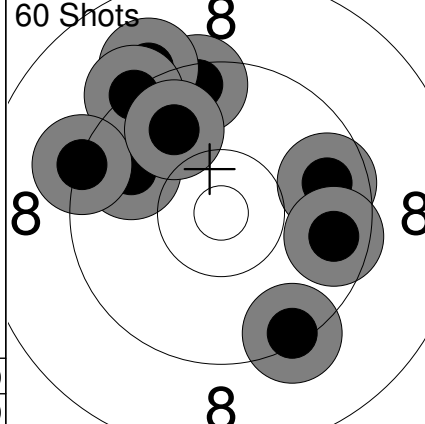
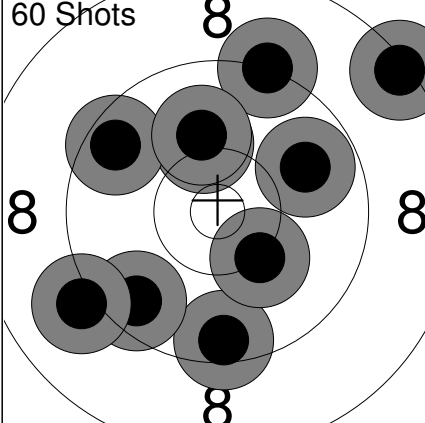
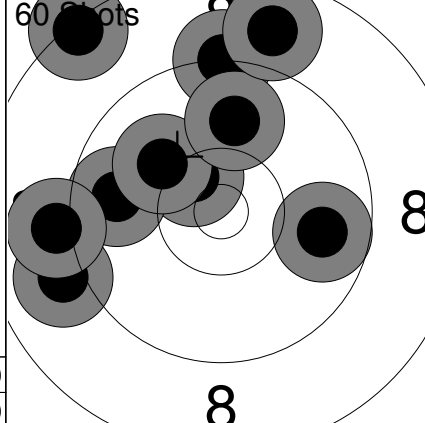
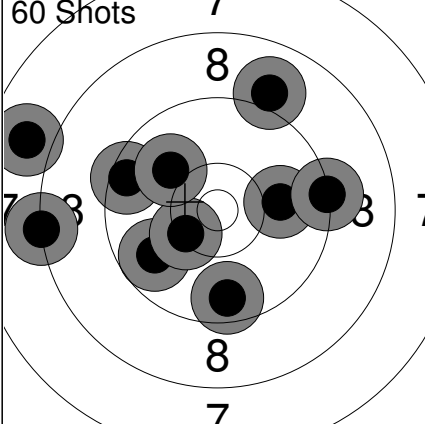
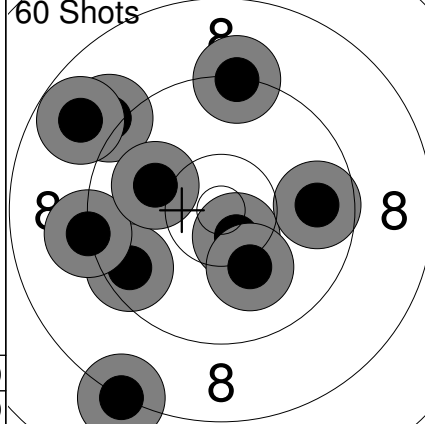
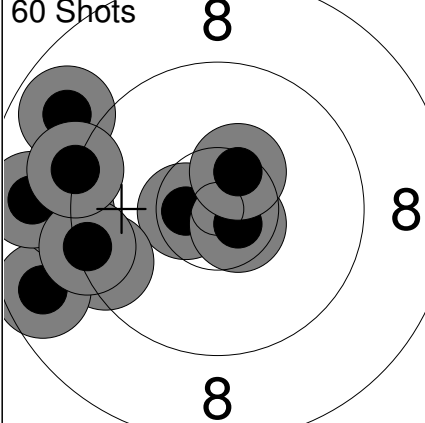
	<p>1: 9.0 ↗</p> <p>2: 9.8 ↗</p> <p>3: 8.8 →</p> <p>4: 9.4 ↘</p> <p>5: 9.9 →</p> <p>6: 8.4 ↘</p> <p>7: 9.4 →</p> <p>8: 8.9 ↘</p> <p>9: 10.3 ↘</p> <p>10: 9.6 ↑</p>		<p>1: 9.7 →</p> <p>2: 9.7 ↗</p> <p>3: 9.4 ↘</p> <p>4: 9.6 →</p> <p>5: 9.5 ↑</p> <p>6: 9.8 ↗</p> <p>7: 9.1 ↗</p> <p>8: 9.3 ↗</p> <p>9: 9.3 ↖</p> <p>10: 9.9 ↗</p>
	<p>Series 88 (0x)</p> <p>0 (0x)</p>		<p>Series 90 (0x)</p> <p>90 (0x)</p>
	<p>11: 9.5 ↓</p> <p>12: 9.8 →</p> <p>13: 9.2 ↑</p> <p>14: 10.2 ↑</p> <p>15: 9.6 ↖</p> <p>16: 9.6 ↗</p> <p>17: 10.1 ↑</p> <p>18: 9.1 ↖</p> <p>19: 10.2 ↘</p> <p>20: 8.3 ↗</p>		<p>21: 9.2 ↑</p> <p>22: 10.5x ↗</p> <p>23: 9.8 →</p> <p>24: 9.0 ↖</p> <p>25: 9.8 ↖</p> <p>26: 10.1 ↗</p> <p>27: 9.9 ↑</p> <p>28: 8.3 ↗</p> <p>29: 8.8 ↑</p> <p>30: 9.1 ↖</p>
	<p>Series 92 (0x)</p> <p>182 (0x)</p>		<p>Series 90 (1x)</p> <p>272 (1x)</p>
	<p>31: 8.2 ↖</p> <p>32: 9.8 ↖</p> <p>33: 10.3 ↖</p> <p>34: 9.5 ↖</p> <p>35: 7.8 ↖</p> <p>36: 10.0 →</p> <p>37: 9.0 ↗</p> <p>38: 10.0 ↗</p> <p>39: 9.3 →</p> <p>40: 9.6 ↓</p>		<p>41: 9.3 ↑</p> <p>42: 10.6x ↘</p> <p>43: 9.1 ↗</p> <p>44: 9.6 ↖</p> <p>45: 10.1 ↘</p> <p>46: 9.2 ↖</p> <p>47: 10.0 ↖</p> <p>48: 9.7 →</p> <p>49: 8.8 ↗</p> <p>50: 8.2 ↘</p>
	<p>Series 90 (0x)</p> <p>362 (1x)</p>		<p>Series 91 (1x)</p> <p>453 (2x)</p>
	<p>51: 10.6x ↖</p> <p>52: 10.6x ↘</p> <p>53: 9.5 ↖</p> <p>54: 8.7 ↖</p> <p>55: 9.2 ↖</p> <p>56: 8.8 ↖</p> <p>57: 9.4 ↖</p> <p>58: 8.9 ↗</p> <p>59: 10.5x ↗</p> <p>60: 9.2 ↖</p>		
	<p>Series 90 (3x)</p> <p>543 (5x)</p>		

Relay <b>1</b>	Lane <b>10</b>	<b>EK Nils</b>
-------------------	-------------------	----------------

2023 SFC Pistol Nationals	QC	EX	MP
---------------------------	----	----	----

15.07.2023	PN23AP-Q-1	Alberta Handgun Association
------------	------------	-----------------------------

Comment	Signature
---------	-----------

<p>Sight</p>	<table style="width:100%; border-collapse: collapse;"> <tr><td>1:</td><td>8.1</td><td>↙</td></tr> <tr><td>2:</td><td>8.5</td><td>↙</td></tr> <tr><td>3:</td><td>9.7</td><td>→</td></tr> <tr><td>4:</td><td>9.4</td><td>←</td></tr> <tr><td>5:</td><td>10.8x</td><td>↑</td></tr> <tr><td>6:</td><td>9.0</td><td>↖</td></tr> <tr><td>7:</td><td>7.2</td><td>↑</td></tr> <tr><td>8:</td><td>9.7</td><td>↖</td></tr> <tr><td>9:</td><td>8.5</td><td>↗</td></tr> <tr><td>10:</td><td>8.1</td><td>↓</td></tr> <tr><td colspan="2">Series</td><td>85 (1x)</td></tr> <tr><td colspan="2"></td><td>0 (0x)</td></tr> </table>	1:	8.1	↙	2:	8.5	↙	3:	9.7	→	4:	9.4	←	5:	10.8x	↑	6:	9.0	↖	7:	7.2	↑	8:	9.7	↖	9:	8.5	↗	10:	8.1	↓	Series		85 (1x)			0 (0x)	<p>Sight</p>	<table style="width:100%; border-collapse: collapse;"> <tr><td>11:</td><td>7.8</td><td>↗</td></tr> <tr><td>12:</td><td>4.9</td><td>→</td></tr> <tr><td>13:</td><td>6.6</td><td>→</td></tr> <tr><td colspan="2">Series</td><td>17 (0x)</td></tr> <tr><td colspan="2"></td><td>0 (0x)</td></tr> </table>	11:	7.8	↗	12:	4.9	→	13:	6.6	→	Series		17 (0x)			0 (0x)																					
1:	8.1	↙																																																																									
2:	8.5	↙																																																																									
3:	9.7	→																																																																									
4:	9.4	←																																																																									
5:	10.8x	↑																																																																									
6:	9.0	↖																																																																									
7:	7.2	↑																																																																									
8:	9.7	↖																																																																									
9:	8.5	↗																																																																									
10:	8.1	↓																																																																									
Series		85 (1x)																																																																									
		0 (0x)																																																																									
11:	7.8	↗																																																																									
12:	4.9	→																																																																									
13:	6.6	→																																																																									
Series		17 (0x)																																																																									
		0 (0x)																																																																									
<p>60 Shots</p>	<table style="width:100%; border-collapse: collapse;"> <tr><td>1:</td><td>8.9</td><td>↙</td></tr> <tr><td>2:</td><td>8.3</td><td>↗</td></tr> <tr><td>3:</td><td>10.0</td><td>←</td></tr> <tr><td>4:</td><td>7.9</td><td>↗</td></tr> <tr><td>5:</td><td>8.9</td><td>↗</td></tr> <tr><td>6:</td><td>9.2</td><td>↖</td></tr> <tr><td>7:</td><td>5.3</td><td>↗</td></tr> <tr><td>8:</td><td>10.1</td><td>→</td></tr> <tr><td>9:</td><td>8.6</td><td>↗</td></tr> <tr><td>10:</td><td>9.4</td><td>↗</td></tr> <tr><td colspan="2">Series</td><td>82 (0x)</td></tr> <tr><td colspan="2"></td><td>82 (0x)</td></tr> </table>	1:	8.9	↙	2:	8.3	↗	3:	10.0	←	4:	7.9	↗	5:	8.9	↗	6:	9.2	↖	7:	5.3	↗	8:	10.1	→	9:	8.6	↗	10:	9.4	↗	Series		82 (0x)			82 (0x)	<p>60 Shots</p>	<table style="width:100%; border-collapse: collapse;"> <tr><td>11:</td><td>8.2</td><td>↑</td></tr> <tr><td>12:</td><td>9.4</td><td>↗</td></tr> <tr><td>13:</td><td>7.3</td><td>↗</td></tr> <tr><td>14:</td><td>8.1</td><td>→</td></tr> <tr><td>15:</td><td>8.6</td><td>↑</td></tr> <tr><td>16:</td><td>9.6</td><td>↗</td></tr> <tr><td>17:</td><td>10.3</td><td>←</td></tr> <tr><td>18:</td><td>4.9</td><td>↗</td></tr> <tr><td>19:</td><td>9.8</td><td>→</td></tr> <tr><td>20:</td><td>9.5</td><td>↑</td></tr> <tr><td colspan="2">Series</td><td>81 (0x)</td></tr> <tr><td colspan="2"></td><td>163 (0x)</td></tr> </table>	11:	8.2	↑	12:	9.4	↗	13:	7.3	↗	14:	8.1	→	15:	8.6	↑	16:	9.6	↗	17:	10.3	←	18:	4.9	↗	19:	9.8	→	20:	9.5	↑	Series		81 (0x)			163 (0x)
1:	8.9	↙																																																																									
2:	8.3	↗																																																																									
3:	10.0	←																																																																									
4:	7.9	↗																																																																									
5:	8.9	↗																																																																									
6:	9.2	↖																																																																									
7:	5.3	↗																																																																									
8:	10.1	→																																																																									
9:	8.6	↗																																																																									
10:	9.4	↗																																																																									
Series		82 (0x)																																																																									
		82 (0x)																																																																									
11:	8.2	↑																																																																									
12:	9.4	↗																																																																									
13:	7.3	↗																																																																									
14:	8.1	→																																																																									
15:	8.6	↑																																																																									
16:	9.6	↗																																																																									
17:	10.3	←																																																																									
18:	4.9	↗																																																																									
19:	9.8	→																																																																									
20:	9.5	↑																																																																									
Series		81 (0x)																																																																									
		163 (0x)																																																																									
<p>60 Shots</p>	<table style="width:100%; border-collapse: collapse;"> <tr><td>21:</td><td>8.8</td><td>↑</td></tr> <tr><td>22:</td><td>8.5</td><td>↑</td></tr> <tr><td>23:</td><td>8.4</td><td>←</td></tr> <tr><td>24:</td><td>8.9</td><td>↑</td></tr> <tr><td>25:</td><td>9.1</td><td>←</td></tr> <tr><td>26:</td><td>8.5</td><td>→</td></tr> <tr><td>27:</td><td>9.4</td><td>↗</td></tr> <tr><td>28:</td><td>8.7</td><td>↑</td></tr> <tr><td>29:</td><td>7.8</td><td>↓</td></tr> <tr><td>30:</td><td>8.9</td><td>↗</td></tr> <tr><td colspan="2">Series</td><td>81 (0x)</td></tr> <tr><td colspan="2"></td><td>244 (0x)</td></tr> </table>	21:	8.8	↑	22:	8.5	↑	23:	8.4	←	24:	8.9	↑	25:	9.1	←	26:	8.5	→	27:	9.4	↗	28:	8.7	↑	29:	7.8	↓	30:	8.9	↗	Series		81 (0x)			244 (0x)	<p>60 Shots</p>	<table style="width:100%; border-collapse: collapse;"> <tr><td>31:</td><td>9.3</td><td>↗</td></tr> <tr><td>32:</td><td>8.4</td><td>←</td></tr> <tr><td>33:</td><td>10.1</td><td>↑</td></tr> <tr><td>34:</td><td>7.6</td><td>→</td></tr> <tr><td>35:</td><td>10.3</td><td>↖</td></tr> <tr><td>36:</td><td>10.1</td><td>←</td></tr> <tr><td>37:</td><td>9.2</td><td>←</td></tr> <tr><td>38:</td><td>10.2</td><td>↗</td></tr> <tr><td>39:</td><td>6.9</td><td>↘</td></tr> <tr><td>40:</td><td>9.7</td><td>↑</td></tr> <tr><td colspan="2">Series</td><td>88 (0x)</td></tr> <tr><td colspan="2"></td><td>332 (0x)</td></tr> </table>	31:	9.3	↗	32:	8.4	←	33:	10.1	↑	34:	7.6	→	35:	10.3	↖	36:	10.1	←	37:	9.2	←	38:	10.2	↗	39:	6.9	↘	40:	9.7	↑	Series		88 (0x)			332 (0x)
21:	8.8	↑																																																																									
22:	8.5	↑																																																																									
23:	8.4	←																																																																									
24:	8.9	↑																																																																									
25:	9.1	←																																																																									
26:	8.5	→																																																																									
27:	9.4	↗																																																																									
28:	8.7	↑																																																																									
29:	7.8	↓																																																																									
30:	8.9	↗																																																																									
Series		81 (0x)																																																																									
		244 (0x)																																																																									
31:	9.3	↗																																																																									
32:	8.4	←																																																																									
33:	10.1	↑																																																																									
34:	7.6	→																																																																									
35:	10.3	↖																																																																									
36:	10.1	←																																																																									
37:	9.2	←																																																																									
38:	10.2	↗																																																																									
39:	6.9	↘																																																																									
40:	9.7	↑																																																																									
Series		88 (0x)																																																																									
		332 (0x)																																																																									
<p>60 Shots</p>	<table style="width:100%; border-collapse: collapse;"> <tr><td>41:</td><td>7.8</td><td>↗</td></tr> <tr><td>42:</td><td>9.5</td><td>↗</td></tr> <tr><td>43:</td><td>8.2</td><td>→</td></tr> <tr><td>44:</td><td>10.4x</td><td>←</td></tr> <tr><td>45:</td><td>9.9</td><td>↓</td></tr> <tr><td>46:</td><td>7.8</td><td>↖</td></tr> <tr><td>47:</td><td>9.2</td><td>↘</td></tr> <tr><td>48:</td><td>9.9</td><td>↑</td></tr> <tr><td>49:</td><td>9.3</td><td>↖</td></tr> <tr><td>50:</td><td>8.8</td><td>←</td></tr> <tr><td colspan="2">Series</td><td>85 (1x)</td></tr> <tr><td colspan="2"></td><td>417 (1x)</td></tr> </table>	41:	7.8	↗	42:	9.5	↗	43:	8.2	→	44:	10.4x	←	45:	9.9	↓	46:	7.8	↖	47:	9.2	↘	48:	9.9	↑	49:	9.3	↖	50:	8.8	←	Series		85 (1x)			417 (1x)	<p>60 Shots</p>	<table style="width:100%; border-collapse: collapse;"> <tr><td>51:</td><td>10.1</td><td>→</td></tr> <tr><td>52:</td><td>8.7</td><td>↖</td></tr> <tr><td>53:</td><td>8.8</td><td>↗</td></tr> <tr><td>54:</td><td>7.0</td><td>←</td></tr> <tr><td>55:</td><td>9.7</td><td>↖</td></tr> <tr><td>56:</td><td>8.8</td><td>→</td></tr> <tr><td>57:</td><td>9.1</td><td>→</td></tr> <tr><td>58:</td><td>8.8</td><td>←</td></tr> <tr><td>59:</td><td>9.4</td><td>↓</td></tr> <tr><td>60:</td><td>8.5</td><td>→</td></tr> <tr><td colspan="2">Series</td><td>84 (0x)</td></tr> <tr><td colspan="2"></td><td>501 (1x)</td></tr> </table>	51:	10.1	→	52:	8.7	↖	53:	8.8	↗	54:	7.0	←	55:	9.7	↖	56:	8.8	→	57:	9.1	→	58:	8.8	←	59:	9.4	↓	60:	8.5	→	Series		84 (0x)			501 (1x)
41:	7.8	↗																																																																									
42:	9.5	↗																																																																									
43:	8.2	→																																																																									
44:	10.4x	←																																																																									
45:	9.9	↓																																																																									
46:	7.8	↖																																																																									
47:	9.2	↘																																																																									
48:	9.9	↑																																																																									
49:	9.3	↖																																																																									
50:	8.8	←																																																																									
Series		85 (1x)																																																																									
		417 (1x)																																																																									
51:	10.1	→																																																																									
52:	8.7	↖																																																																									
53:	8.8	↗																																																																									
54:	7.0	←																																																																									
55:	9.7	↖																																																																									
56:	8.8	→																																																																									
57:	9.1	→																																																																									
58:	8.8	←																																																																									
59:	9.4	↓																																																																									
60:	8.5	→																																																																									
Series		84 (0x)																																																																									
		501 (1x)																																																																									

Comment	Signature
---------	-----------

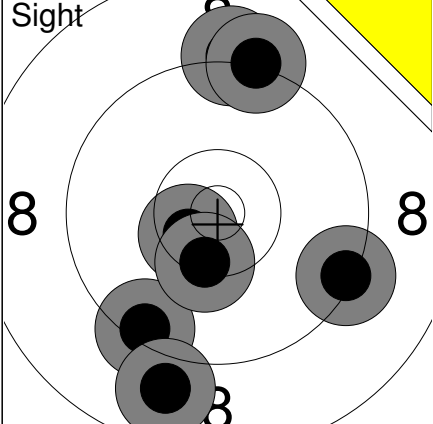
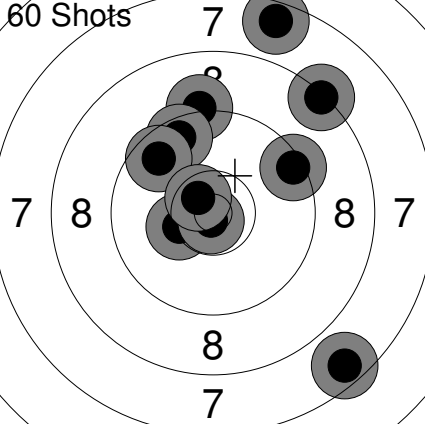
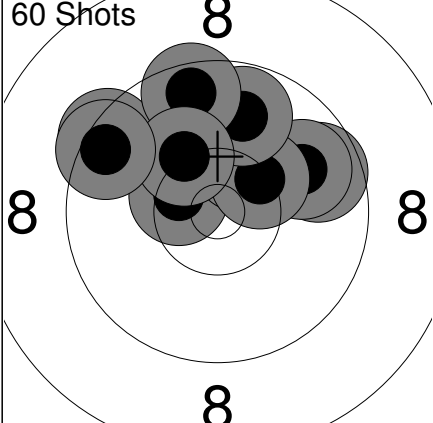
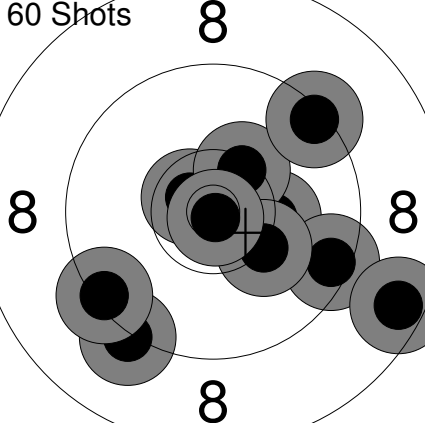
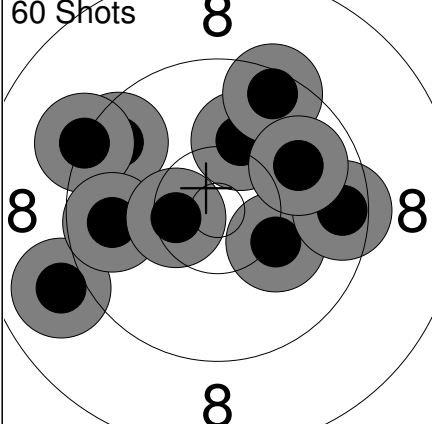
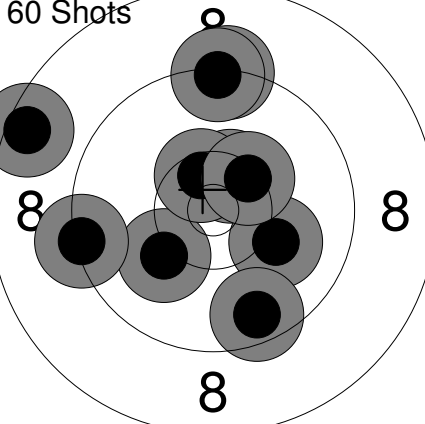
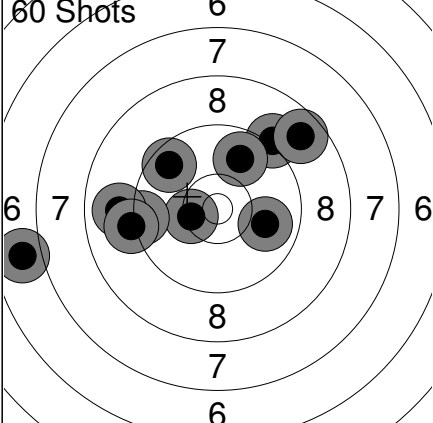
<p>Sight</p> 	<table border="1" style="width:100%; border-collapse: collapse;"> <tr><td>1:</td><td>9.4</td><td>↘</td></tr> <tr><td>2:</td><td>10.5x</td><td>←</td></tr> <tr><td>3:</td><td>9.2</td><td>↑</td></tr> <tr><td>4:</td><td>9.3</td><td>→</td></tr> <tr><td>5:</td><td>8.9</td><td>↘</td></tr> <tr><td>6:</td><td>10.4x</td><td>↘</td></tr> <tr><td>7:</td><td>9.2</td><td>↑</td></tr> <tr><td colspan="2">Series</td><td>64 (2x)</td></tr> <tr><td colspan="2"></td><td>0 (0x)</td></tr> </table>	1:	9.4	↘	2:	10.5x	←	3:	9.2	↑	4:	9.3	→	5:	8.9	↘	6:	10.4x	↘	7:	9.2	↑	Series		64 (2x)			0 (0x)	<p>60 Shots</p> 	<table border="1" style="width:100%; border-collapse: collapse;"> <tr><td>1:</td><td>8.3</td><td>↗</td></tr> <tr><td>2:</td><td>10.3</td><td>←</td></tr> <tr><td>3:</td><td>7.6</td><td>↘</td></tr> <tr><td>4:</td><td>9.4</td><td>→</td></tr> <tr><td>5:</td><td>9.2</td><td>↑</td></tr> <tr><td>6:</td><td>10.8x</td><td>↘</td></tr> <tr><td>7:</td><td>9.6</td><td>↑</td></tr> <tr><td>8:</td><td>9.7</td><td>↗</td></tr> <tr><td>9:</td><td>7.5</td><td>↑</td></tr> <tr><td>10:</td><td>10.6x</td><td>↖</td></tr> <tr><td colspan="2">Series</td><td>88 (2x)</td></tr> <tr><td colspan="2"></td><td>88 (2x)</td></tr> </table>	1:	8.3	↗	2:	10.3	←	3:	7.6	↘	4:	9.4	→	5:	9.2	↑	6:	10.8x	↘	7:	9.6	↑	8:	9.7	↗	9:	7.5	↑	10:	10.6x	↖	Series		88 (2x)			88 (2x)									
1:	9.4	↘																																																																									
2:	10.5x	←																																																																									
3:	9.2	↑																																																																									
4:	9.3	→																																																																									
5:	8.9	↘																																																																									
6:	10.4x	↘																																																																									
7:	9.2	↑																																																																									
Series		64 (2x)																																																																									
		0 (0x)																																																																									
1:	8.3	↗																																																																									
2:	10.3	←																																																																									
3:	7.6	↘																																																																									
4:	9.4	→																																																																									
5:	9.2	↑																																																																									
6:	10.8x	↘																																																																									
7:	9.6	↑																																																																									
8:	9.7	↗																																																																									
9:	7.5	↑																																																																									
10:	10.6x	↖																																																																									
Series		88 (2x)																																																																									
		88 (2x)																																																																									
<p>60 Shots</p> 	<table border="1" style="width:100%; border-collapse: collapse;"> <tr><td>11:</td><td>9.7</td><td>→</td></tr> <tr><td>12:</td><td>10.5x</td><td>↖</td></tr> <tr><td>13:</td><td>9.4</td><td>↗</td></tr> <tr><td>14:</td><td>9.9</td><td>→</td></tr> <tr><td>15:</td><td>10.3</td><td>↑</td></tr> <tr><td>16:</td><td>10.3</td><td>↗</td></tr> <tr><td>17:</td><td>9.8</td><td>↑</td></tr> <tr><td>18:</td><td>9.6</td><td>↑</td></tr> <tr><td>19:</td><td>10.2</td><td>↑</td></tr> <tr><td>20:</td><td>9.5</td><td>↖</td></tr> <tr><td colspan="2">Series</td><td>94 (1x)</td></tr> <tr><td colspan="2"></td><td>182 (3x)</td></tr> </table>	11:	9.7	→	12:	10.5x	↖	13:	9.4	↗	14:	9.9	→	15:	10.3	↑	16:	10.3	↗	17:	9.8	↑	18:	9.6	↑	19:	10.2	↑	20:	9.5	↖	Series		94 (1x)			182 (3x)	<p>60 Shots</p> 	<table border="1" style="width:100%; border-collapse: collapse;"> <tr><td>21:</td><td>9.2</td><td>↘</td></tr> <tr><td>22:</td><td>10.6x</td><td>↖</td></tr> <tr><td>23:</td><td>10.3</td><td>→</td></tr> <tr><td>24:</td><td>9.5</td><td>→</td></tr> <tr><td>25:</td><td>10.4x</td><td>↗</td></tr> <tr><td>26:</td><td>9.4</td><td>↗</td></tr> <tr><td>27:</td><td>10.2</td><td>↘</td></tr> <tr><td>28:</td><td>10.9x</td><td>↘</td></tr> <tr><td>29:</td><td>9.3</td><td>↖</td></tr> <tr><td>30:</td><td>8.5</td><td>→</td></tr> <tr><td colspan="2">Series</td><td>94 (3x)</td></tr> <tr><td colspan="2"></td><td>276 (6x)</td></tr> </table>	21:	9.2	↘	22:	10.6x	↖	23:	10.3	→	24:	9.5	→	25:	10.4x	↗	26:	9.4	↗	27:	10.2	↘	28:	10.9x	↘	29:	9.3	↖	30:	8.5	→	Series		94 (3x)			276 (6x)
11:	9.7	→																																																																									
12:	10.5x	↖																																																																									
13:	9.4	↗																																																																									
14:	9.9	→																																																																									
15:	10.3	↑																																																																									
16:	10.3	↗																																																																									
17:	9.8	↑																																																																									
18:	9.6	↑																																																																									
19:	10.2	↑																																																																									
20:	9.5	↖																																																																									
Series		94 (1x)																																																																									
		182 (3x)																																																																									
21:	9.2	↘																																																																									
22:	10.6x	↖																																																																									
23:	10.3	→																																																																									
24:	9.5	→																																																																									
25:	10.4x	↗																																																																									
26:	9.4	↗																																																																									
27:	10.2	↘																																																																									
28:	10.9x	↘																																																																									
29:	9.3	↖																																																																									
30:	8.5	→																																																																									
Series		94 (3x)																																																																									
		276 (6x)																																																																									
<p>60 Shots</p> 	<table border="1" style="width:100%; border-collapse: collapse;"> <tr><td>31:</td><td>10.2</td><td>→</td></tr> <tr><td>32:</td><td>9.6</td><td>↗</td></tr> <tr><td>33:</td><td>9.3</td><td>↗</td></tr> <tr><td>34:</td><td>9.0</td><td>←</td></tr> <tr><td>35:</td><td>9.7</td><td>←</td></tr> <tr><td>36:</td><td>10.1</td><td>↑</td></tr> <tr><td>37:</td><td>10.5x</td><td>←</td></tr> <tr><td>38:</td><td>9.5</td><td>↑</td></tr> <tr><td>39:</td><td>9.5</td><td>→</td></tr> <tr><td>40:</td><td>9.9</td><td>→</td></tr> <tr><td colspan="2">Series</td><td>93 (1x)</td></tr> <tr><td colspan="2"></td><td>369 (7x)</td></tr> </table>	31:	10.2	→	32:	9.6	↗	33:	9.3	↗	34:	9.0	←	35:	9.7	←	36:	10.1	↑	37:	10.5x	←	38:	9.5	↑	39:	9.5	→	40:	9.9	→	Series		93 (1x)			369 (7x)	<p>60 Shots</p> 	<table border="1" style="width:100%; border-collapse: collapse;"> <tr><td>41:</td><td>10.5x</td><td>↗</td></tr> <tr><td>42:</td><td>9.3</td><td>↑</td></tr> <tr><td>43:</td><td>10.1</td><td>→</td></tr> <tr><td>44:</td><td>9.6</td><td>↘</td></tr> <tr><td>45:</td><td>10.1</td><td>↖</td></tr> <tr><td>46:</td><td>9.3</td><td>↑</td></tr> <tr><td>47:</td><td>9.3</td><td>←</td></tr> <tr><td>48:</td><td>10.5x</td><td>↑</td></tr> <tr><td>49:</td><td>10.4x</td><td>↗</td></tr> <tr><td>50:</td><td>8.5</td><td>↖</td></tr> <tr><td colspan="2">Series</td><td>94 (3x)</td></tr> <tr><td colspan="2"></td><td>463 (10x)</td></tr> </table>	41:	10.5x	↗	42:	9.3	↑	43:	10.1	→	44:	9.6	↘	45:	10.1	↖	46:	9.3	↑	47:	9.3	←	48:	10.5x	↑	49:	10.4x	↗	50:	8.5	↖	Series		94 (3x)			463 (10x)
31:	10.2	→																																																																									
32:	9.6	↗																																																																									
33:	9.3	↗																																																																									
34:	9.0	←																																																																									
35:	9.7	←																																																																									
36:	10.1	↑																																																																									
37:	10.5x	←																																																																									
38:	9.5	↑																																																																									
39:	9.5	→																																																																									
40:	9.9	→																																																																									
Series		93 (1x)																																																																									
		369 (7x)																																																																									
41:	10.5x	↗																																																																									
42:	9.3	↑																																																																									
43:	10.1	→																																																																									
44:	9.6	↘																																																																									
45:	10.1	↖																																																																									
46:	9.3	↑																																																																									
47:	9.3	←																																																																									
48:	10.5x	↑																																																																									
49:	10.4x	↗																																																																									
50:	8.5	↖																																																																									
Series		94 (3x)																																																																									
		463 (10x)																																																																									
<p>60 Shots</p> 	<table border="1" style="width:100%; border-collapse: collapse;"> <tr><td>51:</td><td>9.2</td><td>↗</td></tr> <tr><td>52:</td><td>10.4x</td><td>←</td></tr> <tr><td>53:</td><td>9.6</td><td>↗</td></tr> <tr><td>54:</td><td>9.8</td><td>↑</td></tr> <tr><td>55:</td><td>9.4</td><td>←</td></tr> <tr><td>56:</td><td>8.9</td><td>←</td></tr> <tr><td>57:</td><td>9.9</td><td>→</td></tr> <tr><td>58:</td><td>6.8</td><td>←</td></tr> <tr><td>59:</td><td>8.7</td><td>↗</td></tr> <tr><td>60:</td><td>9.1</td><td>←</td></tr> <tr><td colspan="2">Series</td><td>86 (1x)</td></tr> <tr><td colspan="2"></td><td>549 (11x)</td></tr> </table>	51:	9.2	↗	52:	10.4x	←	53:	9.6	↗	54:	9.8	↑	55:	9.4	←	56:	8.9	←	57:	9.9	→	58:	6.8	←	59:	8.7	↗	60:	9.1	←	Series		86 (1x)			549 (11x)																																						
51:	9.2	↗																																																																									
52:	10.4x	←																																																																									
53:	9.6	↗																																																																									
54:	9.8	↑																																																																									
55:	9.4	←																																																																									
56:	8.9	←																																																																									
57:	9.9	→																																																																									
58:	6.8	←																																																																									
59:	8.7	↗																																																																									
60:	9.1	←																																																																									
Series		86 (1x)																																																																									
		549 (11x)																																																																									

Relay <b>1</b>	Lane <b>13</b>	<b>BURNS Stuart</b>
-------------------	-------------------	---------------------

2023 SFC Pistol Nationals	ON	EX	MP
---------------------------	----	----	----

15.07.2023	PN23AP-Q-1	Alberta Handgun Association
------------	------------	-----------------------------

Comment	Signature
---------	-----------

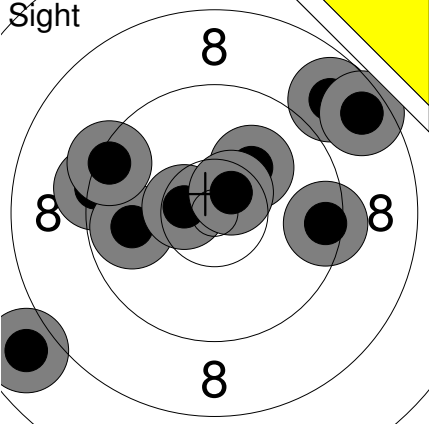
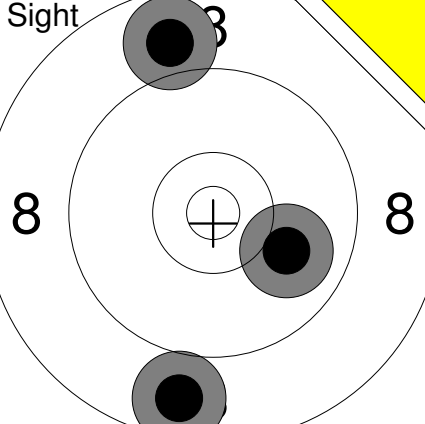
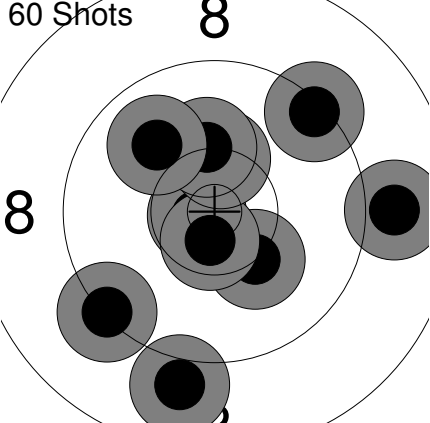
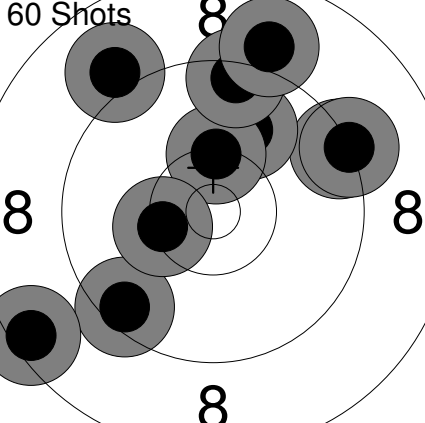
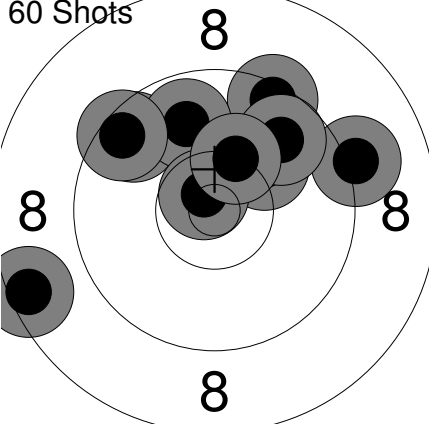
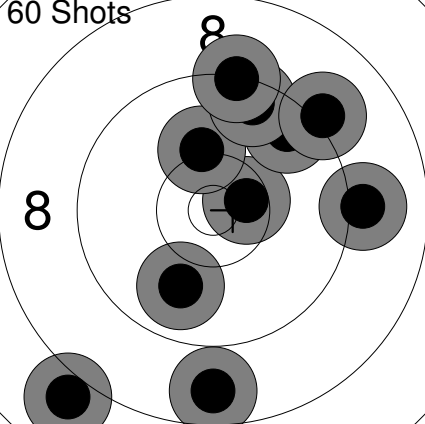
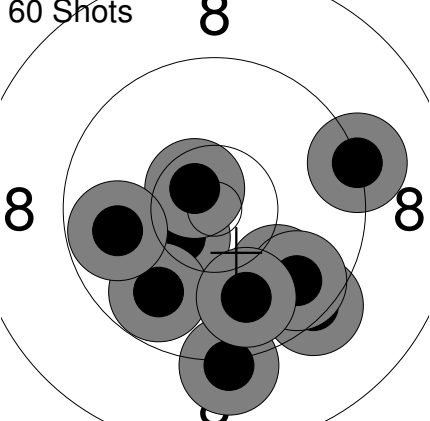
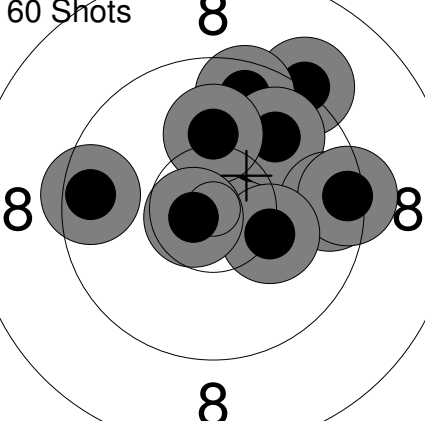
Sight 	1: 10.2 ↗	Sight 	11: 8.9 ↗
	2: 9.3 ←		12: 8.7 ↓
	3: 9.8 ←		13: 10.0 ↘
	4: 7.8 ←		
	5: 9.4 ↗		
	6: 8.8 ↗		
	7: 10.5x ←		
	8: 10.6x ↗		
	9: 8.6 ↗		
	10: 9.5 →		
	Series 89 (2x)		Series 26 (0x)
	0 (0x)		0 (0x)
60 Shots 	1: 10.2 ↘	60 Shots 	11: 9.4 ↗
	2: 9.3 ←		12: 9.0 ↖
	3: 10.7x ←		13: 9.5 ↘
	4: 8.9 →		14: 8.4 ←
	5: 10.6x ↓		15: 9.9 ↗
	6: 9.3 ↗		16: 10.3 ↗
	7: 10.3 ↗		17: 9.4 ↗
	8: 8.9 ↓		18: 9.0 ↗
	9: 10.2 ↗		19: 10.4 ←
	10: 10.0 ↖		20: 9.2 ↗
	Series 94 (2x)		Series 91 (0x)
	94 (2x)		185 (2x)
60 Shots 	21: 9.6 ↖	60 Shots 	31: 9.1 →
	22: 9.1 →		32: 8.7 ↓
	23: 9.4 ↗		33: 10.5x →
	24: 10.1 ↗		34: 10.2 ↗
	25: 9.8 ↗		35: 9.6 ↗
	26: 8.5 ←		36: 9.9 ↓
	27: 9.5 ↗		37: 8.0 ↘
	28: 9.8 ↗		38: 9.5 ↗
	29: 10.7x ↗		39: 9.1 ↗
	30: 10.3 ↗		40: 9.3 ↗
	Series 92 (1x)		Series 90 (1x)
	277 (3x)		367 (4x)
60 Shots 	41: 9.9 ↘	60 Shots 	51: 9.2 ↗
	42: 10.4x ←		52: 9.6 ←
	43: 9.2 ↓		53: 10.2 ↗
	44: 9.2 →		54: 9.6 ↗
	45: 10.6x ↗		55: 9.9 ↗
	46: 9.4 ↓		56: 10.1 ↗
	47: 9.8 ↓		57: 9.6 →
	48: 9.7 ↓		58: 9.4 →
	49: 9.9 ↓		59: 10.2 ↘
	50: 9.8 ←		60: 10.7x ←
	Series 92 (2x)		Series 94 (1x)
	459 (6x)		553 (7x)

Relay **1** Lane **14** **PADDA Davinderjit (dave)**

2023 SFC Pistol Nationals BC EX MP

15.07.2023 PN23AP-Q-1 Alberta Handgun Association

Comment Signature

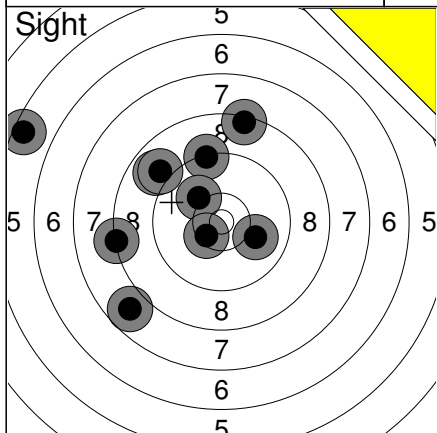
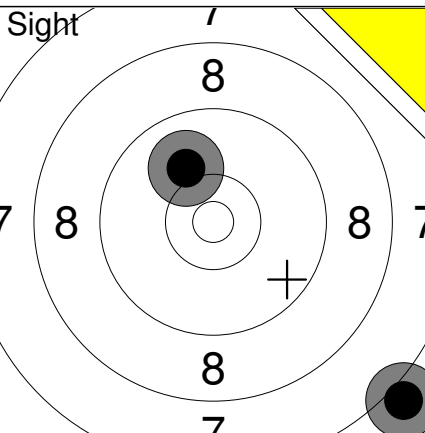
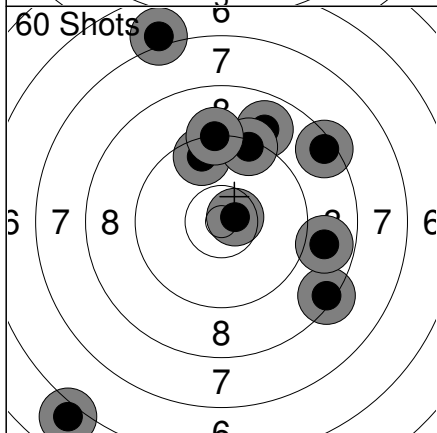
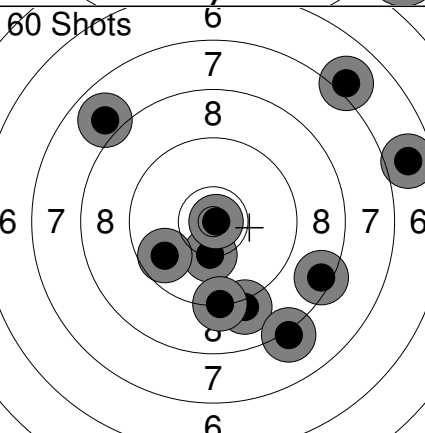
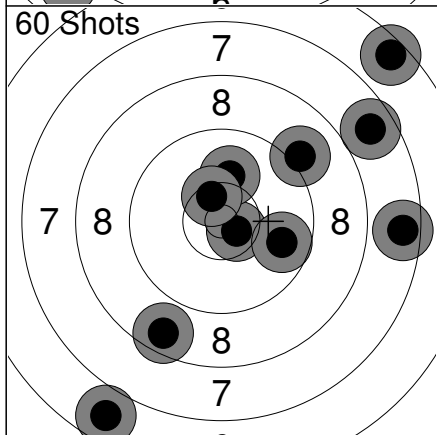
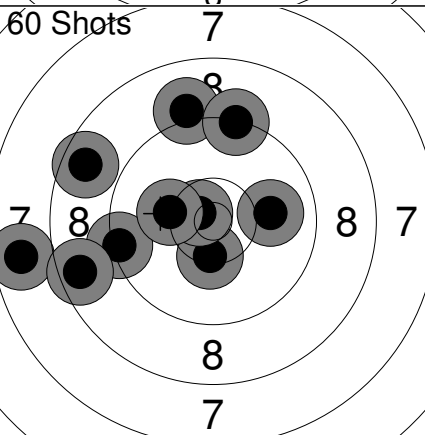
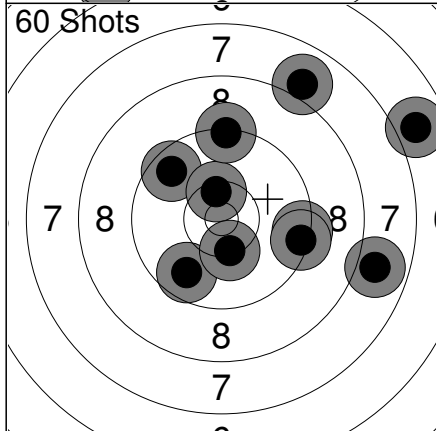
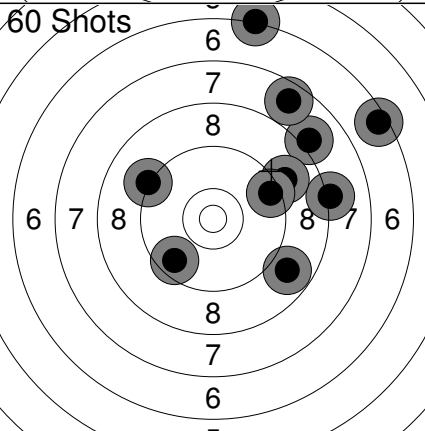
	<p>1: 9.3 ↑ 2: 10.1 ↗ 3: 10.0 → 4: 8.9 ↗ 5: 5.5 ↗ 6: 10.4x ↖ 7: 8.4 ↑ 8: 7.8 ↖ 9: 8.3 ← 10: 8.9 ↗</p> <p>Series 83 (1x) 0 (0x)</p>		<p>11: 10.0 ↗ 12: 7.0 ↘</p> <p>Series 17 (0x) 0 (0x)</p>
	<p>1: 8.9 ↑ 2: 9.6 ↑ 3: 9.4 ↑ 4: 10.7x → 5: 8.4 ↗ 6: 7.0 ↗ 7: 9.2 ↑ 8: 8.4 ↘ 9: 6.0 ↘ 10: 8.8 →</p> <p>Series 82 (1x) 82 (1x)</p>		<p>11: 9.1 ↓ 12: 10.3 ↓ 13: 6.8 → 14: 8.2 ↘ 15: 7.9 ↗ 16: 9.7 ↖ 17: 10.9x → 18: 7.0 ↗ 19: 9.3 ↓ 20: 8.5 →</p> <p>Series 83 (1x) 165 (2x)</p>
	<p>21: 8.6 ↓ 22: 6.5 ↗ 23: 10.6x ↘ 24: 6.7 ↘ 25: 7.6 → 26: 9.8 → 27: 7.7 → 28: 10.1 ↑ 29: 9.0 ↗ 30: 10.4x ↑</p> <p>Series 82 (2x) 247 (4x)</p>		<p>31: 9.1 ↑ 32: 10.4x ↓ 33: 10.0 → 34: 7.7 ← 35: 8.6 ← 36: 10.7x ↖ 37: 9.3 ← 38: 9.3 ↑ 39: 10.2 ← 40: 8.6 ←</p> <p>Series 90 (2x) 337 (6x)</p>
	<p>41: 9.6 ↖ 42: 10.4x ↑ 43: 8.0 ↑ 44: 7.9 → 45: 9.7 ↘ 46: 6.9 → 47: 9.4 → 48: 10.3 ↓ 49: 9.3 ↑ 50: 9.4 →</p> <p>Series 86 (1x) 423 (7x)</p>		<p>51: 8.1 → 52: 9.6 ↘ 53: 6.4 ↗ 54: 9.2 ↖ 55: 8.0 ↗ 56: 8.8 ↘ 57: 9.0 ↗ 58: 6.2 ↑ 59: 7.7 ↗ 60: 9.5 →</p> <p>Series 79 (0x) 502 (7x)</p>



Relay **1** Lane **15** **PADDA Kulwinderjit**

2023 SFC Pistol Nationals BC EX MP

15.07.2023 PN23AP-Q-1 Alberta Handgun Association

Comment Signature

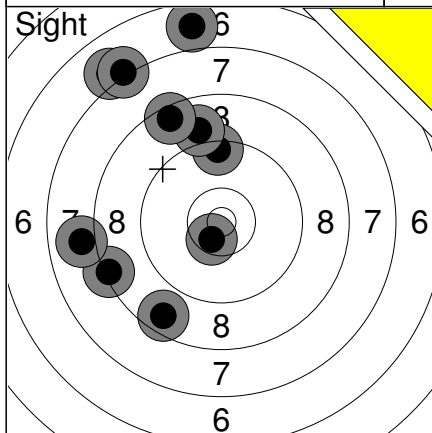

1:	9.4	↑
2:	8.6	↓
3:	7.0	↗
4:	9.0	↑
5:	8.3	←
6:	6.7	↑
7:	10.5x	↓
8:	7.1	↗
9:	8.5	↑
10:	7.9	←
Series	79 (1x)	
	0 (0x)	

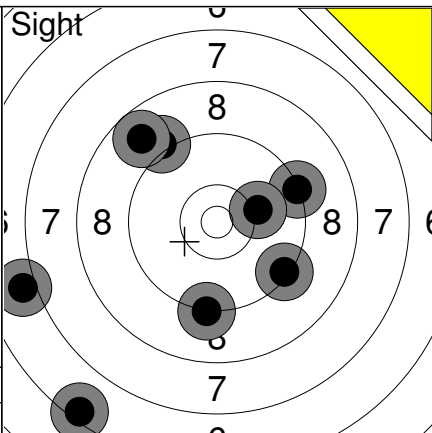

11:	7.0	←
12:	9.3	↗
13:	10.1	→
14:	6.4	↓
15:	9.3	↘
16:	9.1	↗
17:	8.8	↗
18:	9.2	↓
Series	67 (0x)	
	0 (0x)	

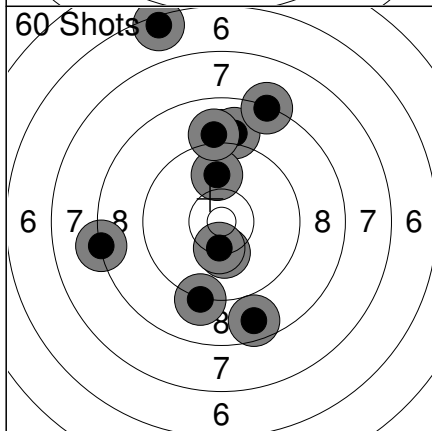

1:	8.7	↓
2:	9.0	↑
3:	8.3	←
4:	9.2	↓
5:	6.4	↑
6:	10.3	↓
7:	9.9	↑
8:	10.4x	↓
9:	8.3	↑
10:	9.0	↑
Series	86 (1x)	
	86 (1x)	

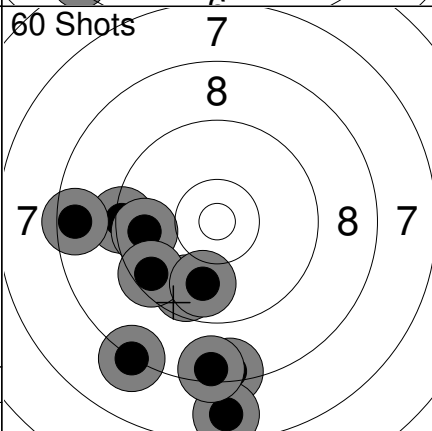

11:	8.4	↓
12:	9.7	↓
13:	7.7	↓
14:	9.3	←
15:	9.7	←
16:	8.5	←
17:	9.5	↙
18:	8.2	↓
19:	8.4	↓
20:	9.9	↓
Series	84 (0x)	
	170 (1x)	

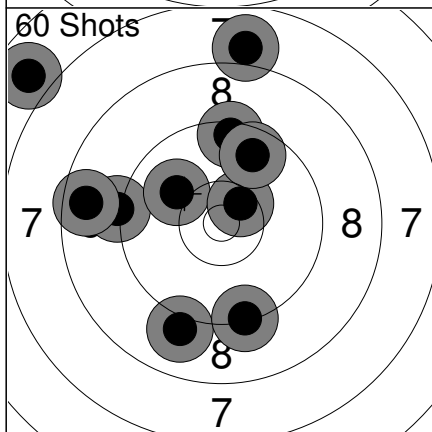

21:	9.2	←
22:	7.9	↑
23:	6.8	↗
24:	10.0	↗
25:	10.5x	↗
26:	9.4	↑
27:	9.0	↓
28:	8.6	←
29:	9.7	↑
30:	9.3	↓
Series	86 (1x)	
	256 (2x)	

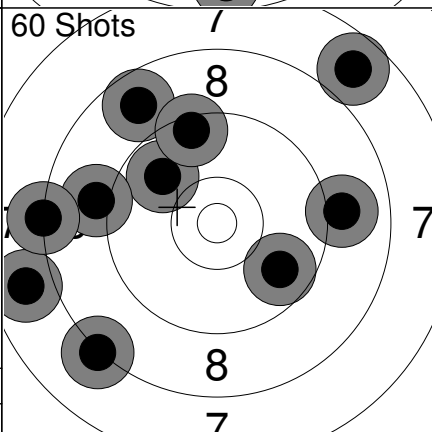

31:	9.8	↗
32:	8.2	↙
33:	9.0	←
34:	8.7	↗
35:	9.0	→
36:	9.7	↘
37:	7.8	←
38:	9.4	↑
39:	8.2	←
40:	7.7	↗
Series	83 (0x)	
	339 (2x)	

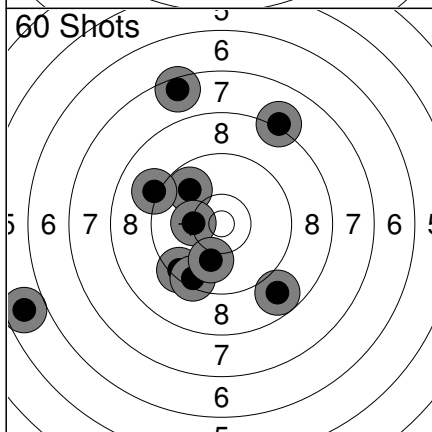

41:	9.4	↙
42:	8.1	↗
43:	9.4	↓
44:	8.8	↓
45:	9.8	↗
46:	5.7	←
47:	10.3	←
48:	7.5	↑
49:	9.1	↖
50:	10.0	↓
Series	84 (0x)	
	423 (2x)	

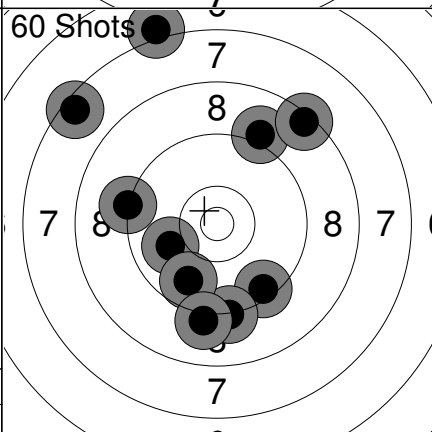

51:	7.1	↑
52:	9.1	↑
53:	8.4	↗
54:	9.2	←
55:	9.4	↓
56:	10.0	←
57:	9.2	↓
58:	9.7	↓
59:	7.5	↖
60:	9.1	↓
Series	86 (0x)	
	509 (2x)	

Relay **1** Lane **16** **KELLY Michael**

2023 SFC Pistol Nationals NS EX MP

15.07.2023 PN23AP-Q-1 Alberta Handgun Association

Comment Signature

	<p>1: 10.2 ↗            2: 10.0 ↗            3: 7.6 →            4: 9.6 ↘            5: 7.8 →            6: 8.6 ↘            7: 8.7 →            8: 7.5 ↑            9: 8.5 →            10: 9.5 ↓</p> <p>Series 83 (0x) 0 (0x)</p>		<p>11: 10.1 ↓            12: 8.6 ↗            13: 8.9 ↑            14: 10.3 ↘            15: 8.7 ↑            16: 9.0 ↘            17: 8.7 →            18: 8.9 ↘            19: 9.0 ↗            20: 9.6 ↓</p> <p>Series 87 (0x) 0 (0x)</p>
	<p>1: 9.3 →            2: 8.6 ↗            3: 7.8 ↘            4: 9.9 ↘            5: 10.5x ←            6: 6.1 →            7: 9.6 ↗            8: 9.4 ↗            9: 9.2 ↗            10: 8.6 ↓</p> <p>Series 84 (1x) 84 (1x)</p>		<p>11: 8.7 →            12: 7.9 ↘            13: 9.1 ←            14: 6.6 ↗            15: 8.4 ↘            16: 7.8 ↗            17: 8.2 ←            18: 7.7 →            19: 8.7 ←            20: 9.8 ↗</p> <p>Series 77 (0x) 161 (1x)</p>
	<p>21: 9.8 →            22: 10.0 ↗            23: 9.9 →            24: 8.9 ↘            25: 9.9 ↘            26: 10.1 ←            27: 9.6 ↘            28: 8.9 ↘            29: 7.3 ↗            30: 10.1 ↘</p> <p>Series 89 (0x) 250 (1x)</p>		<p>31: 10.0 ↘            32: 8.6 ↑            33: 8.5 →            34: 8.7 ↘            35: 10.5x ↗            36: 7.0 →            37: 8.8 ↘            38: 8.4 ↘            39: 10.3 ↗            40: 5.5 →</p> <p>Series 82 (1x) 332 (2x)</p>
	<p>41: 10.2 ↓            42: 9.1 ↑            43: 9.6 ↗            44: 9.0 ↘            45: 9.9 ↘            46: 9.7 ↘            47: 9.5 ↗            48: 10.9x ↗            49: 9.9 →            50: 8.8 ←</p> <p>Series 91 (1x) 423 (3x)</p>		<p>51: 9.8 ↓            52: 8.2 ↗            53: 8.3 ↗            54: 8.3 →            55: 9.5 ↘            56: 8.8 ↘            57: 9.9 ↗            58: 9.5 ↑            59: 8.4 ↘            60: 8.8 ↘</p> <p>Series 84 (0x) 507 (3x)</p>

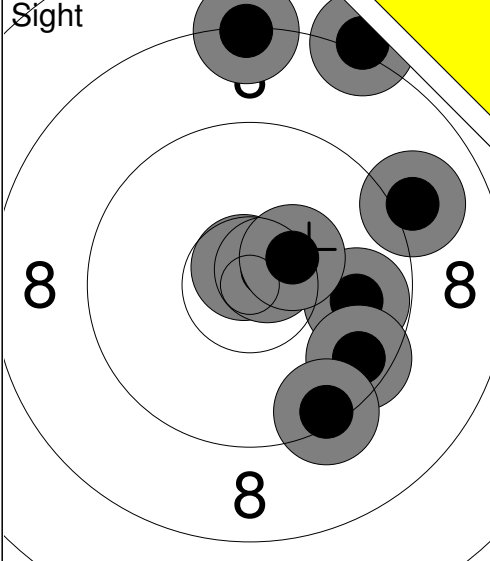
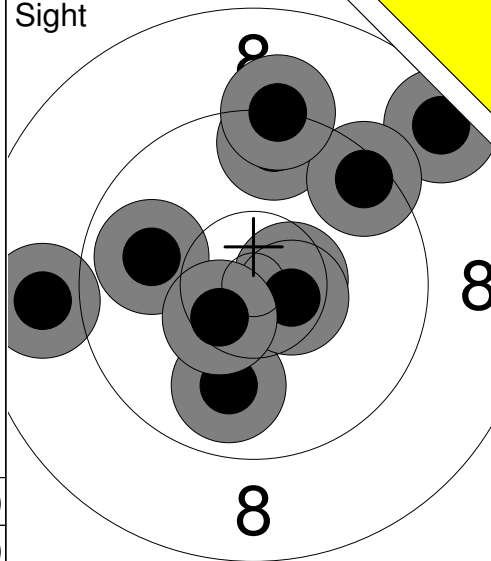
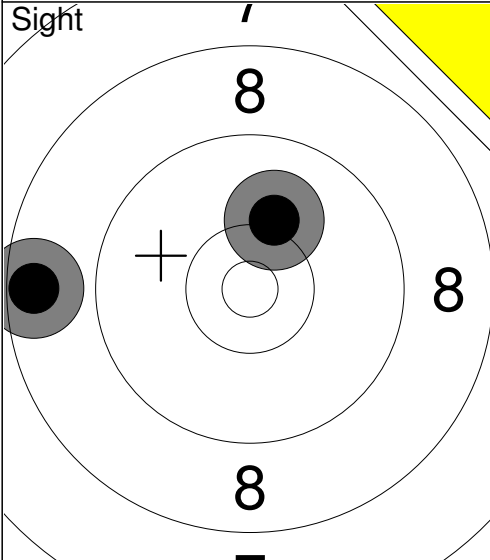
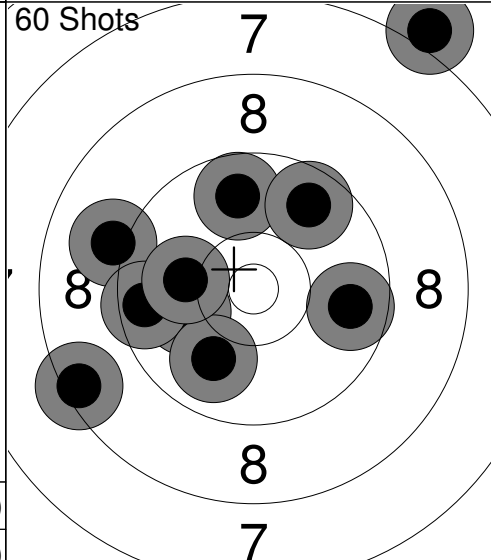
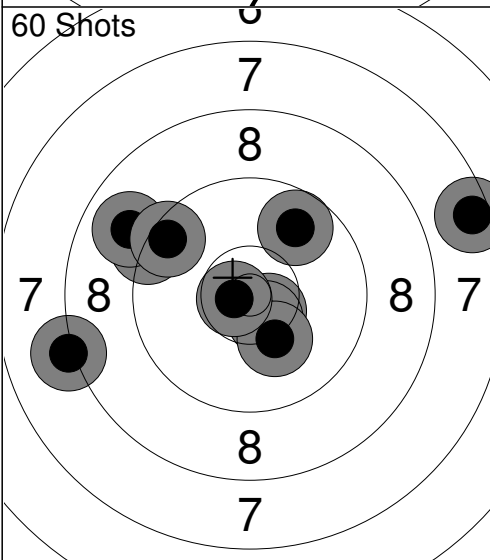
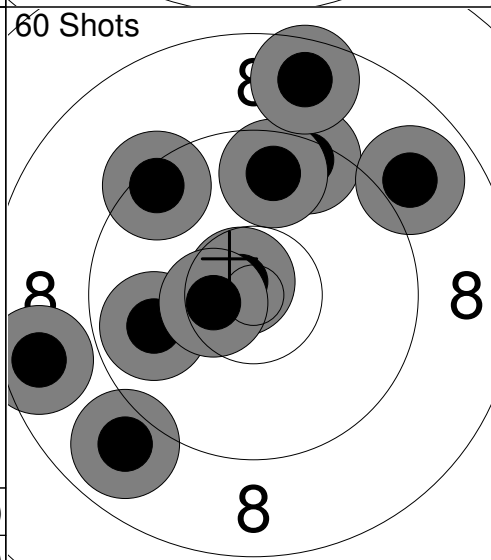
<p>Sight</p>  <p style="text-align: center;"><b>8</b></p>	<p>1: 8.3 ↑</p> <p>2: 9.0 →</p> <p>3: 10.8x ↑</p> <p>5: 8.1 ↑</p> <p>6: 9.8 →</p> <p>7: 10.7x →</p> <p>8: 9.6 →</p> <p>9: 9.4 ↓</p> <p>10: 10.4x →</p>	<p>Sight</p>  <p style="text-align: center;"><b>8</b></p>	<p>11: 9.9 ↓</p> <p>12: 8.5 →</p> <p>13: 9.5 ↑</p> <p>14: 10.6x →</p> <p>15: 9.4 →</p> <p>16: 10.6x →</p> <p>17: 8.9 ←</p> <p>18: 9.9 ←</p> <p>19: 10.5x ↙</p> <p>20: 9.2 ↑</p>
Series 82 ( 3x)		Series 91 ( 3x)	
0 ( 0x)		0 ( 0x)	
<p>Sight</p>  <p style="text-align: center;"><b>8</b></p>	<p>21: 8.5 ←</p> <p>22: 10.1 ↑</p>	<p>60 Shots</p>  <p style="text-align: center;"><b>7</b></p>	<p>1: 9.1 ←</p> <p>2: 10.1 ←</p> <p>3: 9.8 ↑</p> <p>4: 7.0 →</p> <p>5: 9.6 ←</p> <p>6: 9.9 ↓</p> <p>7: 9.7 →</p> <p>8: 9.7 ↑</p> <p>9: 10.1 ←</p> <p>10: 8.4 ←</p>
Series 18 ( 0x)		Series 89 ( 0x)	
0 ( 0x)		89 ( 0x)	
<p>60 Shots</p>  <p style="text-align: center;"><b>7</b></p>	<p>11: 9.3 ←</p> <p>12: 10.6x ↘</p> <p>13: 8.2 ←</p> <p>14: 10.5x ↘</p> <p>15: 7.5 →</p> <p>16: 8.9 ←</p> <p>17: 10.2 ↓</p> <p>18: 9.5 →</p> <p>19: 9.8 ↑</p> <p>20: 10.7x ←</p>	<p>60 Shots</p>  <p style="text-align: center;"><b>8</b></p>	<p>21: 9.4 ↑</p> <p>22: 10.8x ↖</p> <p>23: 8.9 →</p> <p>24: 9.9 ←</p> <p>25: 9.7 ↑</p> <p>26: 9.4 ↖</p> <p>27: 10.5x ←</p> <p>28: 8.6 ←</p> <p>29: 8.9 ↓</p> <p>30: 8.6 ↑</p>
Series 90 ( 3x)		Series 88 ( 2x)	
179 ( 3x)		267 ( 5x)	

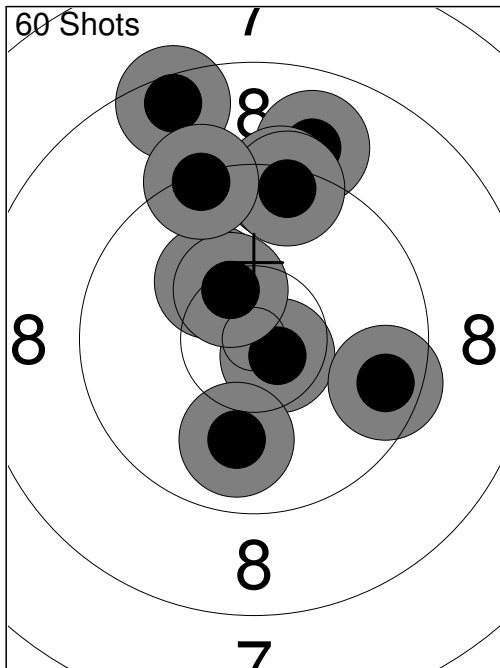

31:	10.3	↖
32:	10.7x	↘
33:	10.4x	↖
34:	9.6	→
35:	9.0	↑
36:	8.5	↑
37:	9.9	↓
38:	9.4	↑
39:	9.4	↑
40:	9.3	↑
Series	92 ( 2x)	
	359 ( 7x)	

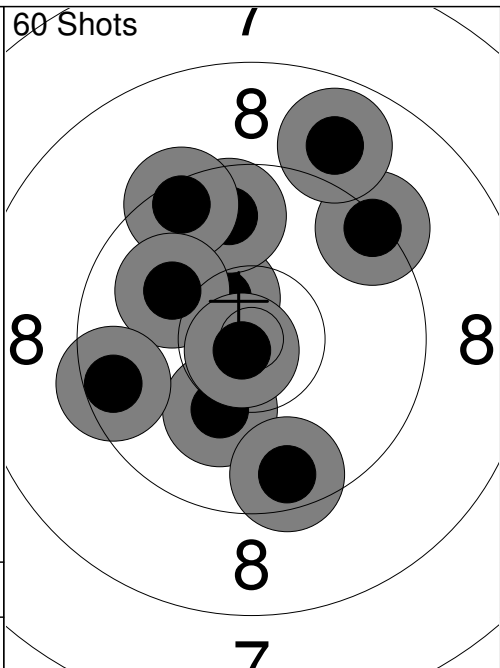

41:	10.5x	↖
42:	9.3	↗
43:	8.9	↑
44:	9.7	↑
45:	9.5	↖
46:	10.2	↘
47:	9.6	↓
48:	10.0	↖
49:	10.8x	↘
50:	9.5	←
Series	93 ( 2x)	
	452 ( 9x)	

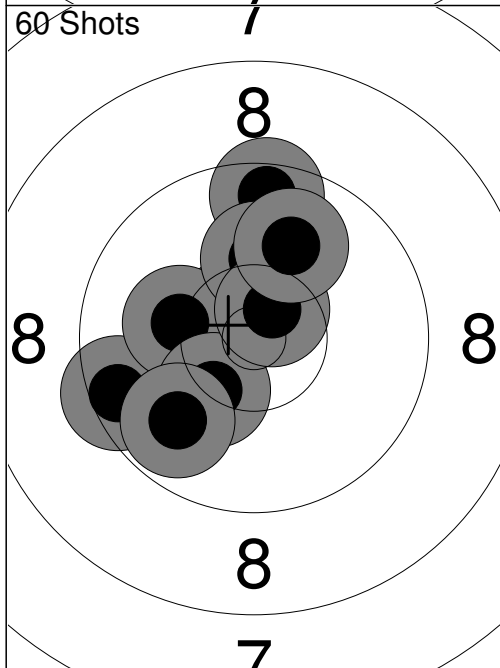

51:	10.6x	↖
52:	9.5	←
53:	9.5	↑
54:	10.4	←
55:	10.2	←
56:	10.3	↘
57:	10.2	↑
58:	10.6x	↗
59:	9.8	↘
60:	10.0	↑
Series	97 ( 2x)	
	549 ( 11x)	

<b>Relay</b> 1	<b>Lane</b> 18	<b>OLSEN Jesse</b>
-------------------	-------------------	--------------------

2023 SFC Pistol Nationals	SK	EX	MP
---------------------------	----	----	----

15.07.2023	PN23AP-Q-1	Alberta Handgun Association
------------	------------	-----------------------------

Comment	Signature
---------	-----------

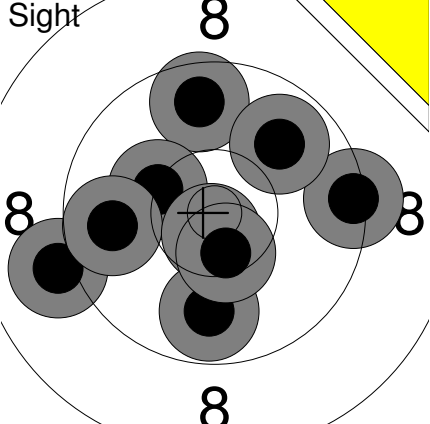
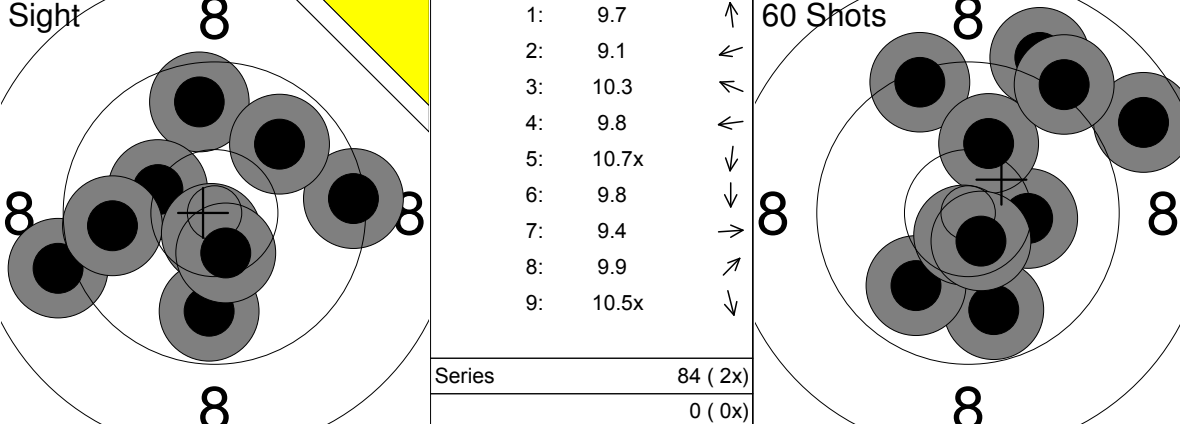
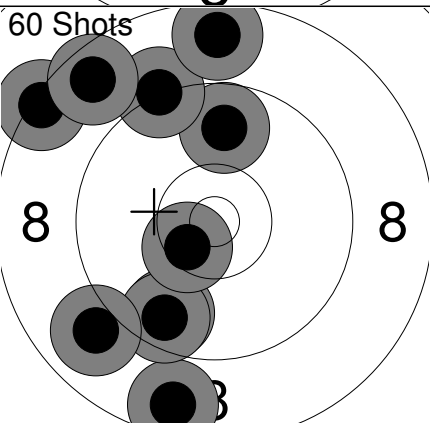
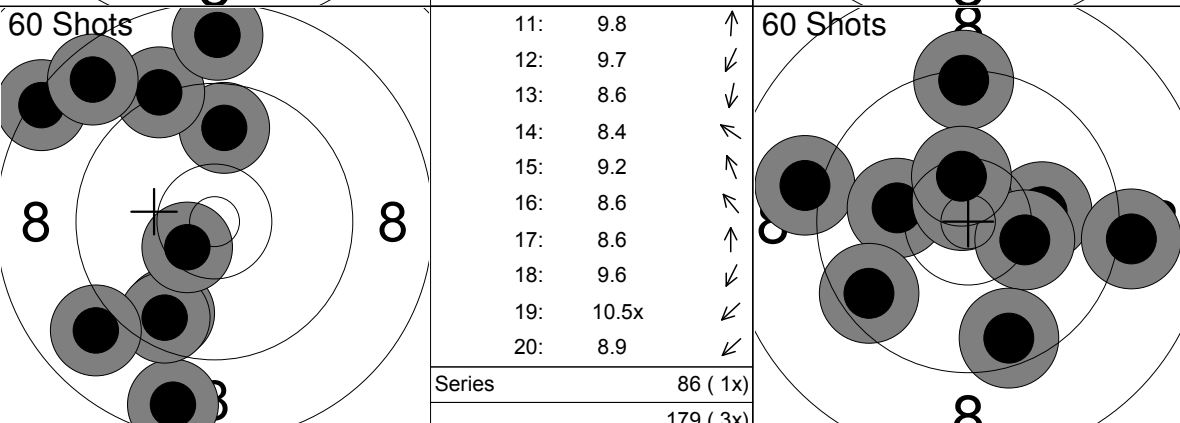
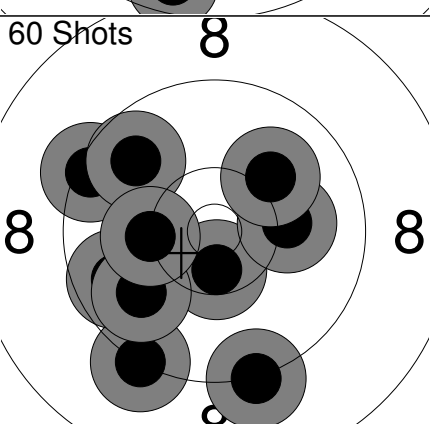
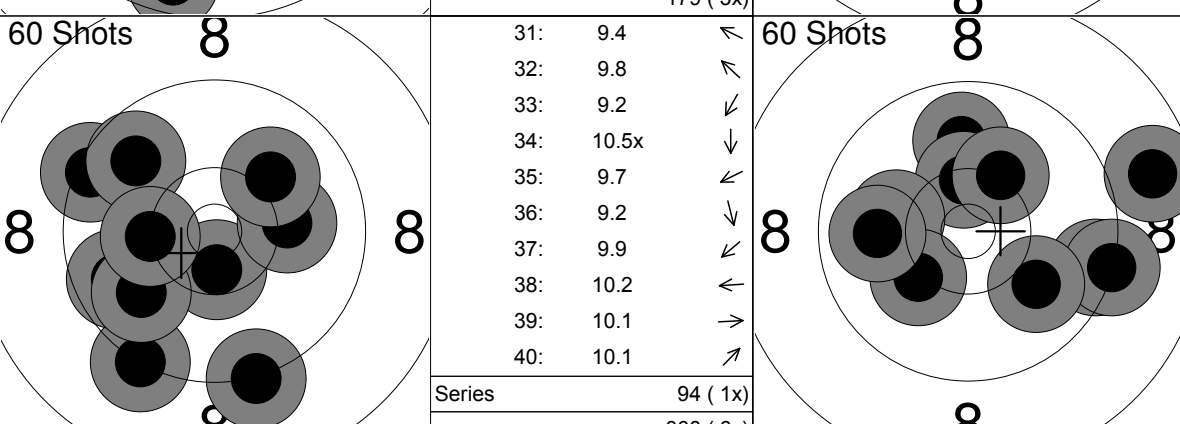
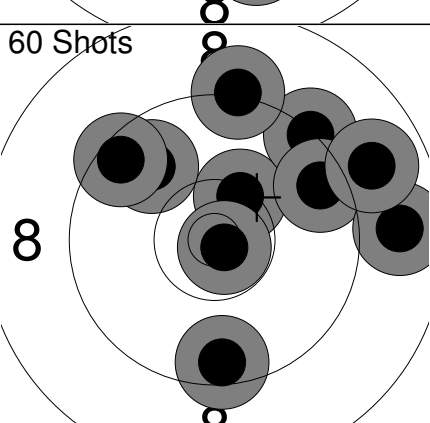
<b>Sight</b> 	<table border="1" style="width:100%; border-collapse: collapse;"> <tr><td>1:</td><td>9.7</td><td>↑</td></tr> <tr><td>2:</td><td>9.1</td><td>←</td></tr> <tr><td>3:</td><td>10.3</td><td>↖</td></tr> <tr><td>4:</td><td>9.8</td><td>←</td></tr> <tr><td>5:</td><td>10.7x</td><td>↓</td></tr> <tr><td>6:</td><td>9.8</td><td>↓</td></tr> <tr><td>7:</td><td>9.4</td><td>→</td></tr> <tr><td>8:</td><td>9.9</td><td>↗</td></tr> <tr><td>9:</td><td>10.5x</td><td>↓</td></tr> <tr><td colspan="2"><b>Series</b></td><td>84 (2x)</td></tr> <tr><td colspan="2"></td><td>0 (0x)</td></tr> </table>	1:	9.7	↑	2:	9.1	←	3:	10.3	↖	4:	9.8	←	5:	10.7x	↓	6:	9.8	↓	7:	9.4	→	8:	9.9	↗	9:	10.5x	↓	<b>Series</b>		84 (2x)			0 (0x)	<b>60 Shots</b>  <table border="1" style="width:100%; border-collapse: collapse;"> <tr><td>1:</td><td>9.4</td><td>↑</td></tr> <tr><td>2:</td><td>10.3</td><td>→</td></tr> <tr><td>3:</td><td>9.8</td><td>↓</td></tr> <tr><td>4:</td><td>10.1</td><td>↑</td></tr> <tr><td>5:</td><td>9.0</td><td>↑</td></tr> <tr><td>6:</td><td>8.7</td><td>↗</td></tr> <tr><td>7:</td><td>9.9</td><td>↙</td></tr> <tr><td>8:</td><td>10.7x</td><td>↓</td></tr> <tr><td>9:</td><td>10.6x</td><td>↓</td></tr> <tr><td>10:</td><td>9.1</td><td>↗</td></tr> <tr><td colspan="2"><b>Series</b></td><td>93 (2x)</td></tr> <tr><td colspan="2"></td><td>93 (2x)</td></tr> </table>	1:	9.4	↑	2:	10.3	→	3:	9.8	↓	4:	10.1	↑	5:	9.0	↑	6:	8.7	↗	7:	9.9	↙	8:	10.7x	↓	9:	10.6x	↓	10:	9.1	↗	<b>Series</b>		93 (2x)			93 (2x)				
1:	9.7	↑																																																																									
2:	9.1	←																																																																									
3:	10.3	↖																																																																									
4:	9.8	←																																																																									
5:	10.7x	↓																																																																									
6:	9.8	↓																																																																									
7:	9.4	→																																																																									
8:	9.9	↗																																																																									
9:	10.5x	↓																																																																									
<b>Series</b>		84 (2x)																																																																									
		0 (0x)																																																																									
1:	9.4	↑																																																																									
2:	10.3	→																																																																									
3:	9.8	↓																																																																									
4:	10.1	↑																																																																									
5:	9.0	↑																																																																									
6:	8.7	↗																																																																									
7:	9.9	↙																																																																									
8:	10.7x	↓																																																																									
9:	10.6x	↓																																																																									
10:	9.1	↗																																																																									
<b>Series</b>		93 (2x)																																																																									
		93 (2x)																																																																									
<b>60 Shots</b> 	<table border="1" style="width:100%; border-collapse: collapse;"> <tr><td>11:</td><td>9.8</td><td>↑</td></tr> <tr><td>12:</td><td>9.7</td><td>↓</td></tr> <tr><td>13:</td><td>8.6</td><td>↓</td></tr> <tr><td>14:</td><td>8.4</td><td>↖</td></tr> <tr><td>15:</td><td>9.2</td><td>↗</td></tr> <tr><td>16:</td><td>8.6</td><td>↗</td></tr> <tr><td>17:</td><td>8.6</td><td>↑</td></tr> <tr><td>18:</td><td>9.6</td><td>↓</td></tr> <tr><td>19:</td><td>10.5x</td><td>↙</td></tr> <tr><td>20:</td><td>8.9</td><td>↙</td></tr> <tr><td colspan="2"><b>Series</b></td><td>86 (1x)</td></tr> <tr><td colspan="2"></td><td>179 (3x)</td></tr> </table>	11:	9.8	↑	12:	9.7	↓	13:	8.6	↓	14:	8.4	↖	15:	9.2	↗	16:	8.6	↗	17:	8.6	↑	18:	9.6	↓	19:	10.5x	↙	20:	8.9	↙	<b>Series</b>		86 (1x)			179 (3x)	<b>60 Shots</b>  <table border="1" style="width:100%; border-collapse: collapse;"> <tr><td>21:</td><td>10.1</td><td>→</td></tr> <tr><td>22:</td><td>9.1</td><td>←</td></tr> <tr><td>23:</td><td>9.3</td><td>↑</td></tr> <tr><td>24:</td><td>10.1</td><td>←</td></tr> <tr><td>25:</td><td>10.7x</td><td>↑</td></tr> <tr><td>26:</td><td>9.6</td><td>↙</td></tr> <tr><td>27:</td><td>10.3</td><td>→</td></tr> <tr><td>28:</td><td>9.6</td><td>↓</td></tr> <tr><td>29:</td><td>10.4x</td><td>↑</td></tr> <tr><td>30:</td><td>9.1</td><td>→</td></tr> <tr><td colspan="2"><b>Series</b></td><td>95 (2x)</td></tr> <tr><td colspan="2"></td><td>274 (5x)</td></tr> </table>	21:	10.1	→	22:	9.1	←	23:	9.3	↑	24:	10.1	←	25:	10.7x	↑	26:	9.6	↙	27:	10.3	→	28:	9.6	↓	29:	10.4x	↑	30:	9.1	→	<b>Series</b>		95 (2x)			274 (5x)	
11:	9.8	↑																																																																									
12:	9.7	↓																																																																									
13:	8.6	↓																																																																									
14:	8.4	↖																																																																									
15:	9.2	↗																																																																									
16:	8.6	↗																																																																									
17:	8.6	↑																																																																									
18:	9.6	↓																																																																									
19:	10.5x	↙																																																																									
20:	8.9	↙																																																																									
<b>Series</b>		86 (1x)																																																																									
		179 (3x)																																																																									
21:	10.1	→																																																																									
22:	9.1	←																																																																									
23:	9.3	↑																																																																									
24:	10.1	←																																																																									
25:	10.7x	↑																																																																									
26:	9.6	↙																																																																									
27:	10.3	→																																																																									
28:	9.6	↓																																																																									
29:	10.4x	↑																																																																									
30:	9.1	→																																																																									
<b>Series</b>		95 (2x)																																																																									
		274 (5x)																																																																									
<b>60 Shots</b> 	<table border="1" style="width:100%; border-collapse: collapse;"> <tr><td>31:</td><td>9.4</td><td>←</td></tr> <tr><td>32:</td><td>9.8</td><td>↗</td></tr> <tr><td>33:</td><td>9.2</td><td>↓</td></tr> <tr><td>34:</td><td>10.5x</td><td>↓</td></tr> <tr><td>35:</td><td>9.7</td><td>←</td></tr> <tr><td>36:</td><td>9.2</td><td>↓</td></tr> <tr><td>37:</td><td>9.9</td><td>↙</td></tr> <tr><td>38:</td><td>10.2</td><td>←</td></tr> <tr><td>39:</td><td>10.1</td><td>→</td></tr> <tr><td>40:</td><td>10.1</td><td>↗</td></tr> <tr><td colspan="2"><b>Series</b></td><td>94 (1x)</td></tr> <tr><td colspan="2"></td><td>368 (6x)</td></tr> </table>	31:	9.4	←	32:	9.8	↗	33:	9.2	↓	34:	10.5x	↓	35:	9.7	←	36:	9.2	↓	37:	9.9	↙	38:	10.2	←	39:	10.1	→	40:	10.1	↗	<b>Series</b>		94 (1x)			368 (6x)	<b>60 Shots</b>  <table border="1" style="width:100%; border-collapse: collapse;"> <tr><td>41:</td><td>9.9</td><td>↑</td></tr> <tr><td>42:</td><td>10.4x</td><td>↑</td></tr> <tr><td>43:</td><td>10.1</td><td>←</td></tr> <tr><td>44:</td><td>9.4</td><td>→</td></tr> <tr><td>45:</td><td>8.7</td><td>→</td></tr> <tr><td>46:</td><td>9.2</td><td>→</td></tr> <tr><td>47:</td><td>10.2</td><td>↙</td></tr> <tr><td>48:</td><td>9.9</td><td>←</td></tr> <tr><td>49:</td><td>10.2</td><td>↗</td></tr> <tr><td>50:</td><td>10.0</td><td>↓</td></tr> <tr><td colspan="2"><b>Series</b></td><td>94 (1x)</td></tr> <tr><td colspan="2"></td><td>462 (7x)</td></tr> </table>	41:	9.9	↑	42:	10.4x	↑	43:	10.1	←	44:	9.4	→	45:	8.7	→	46:	9.2	→	47:	10.2	↙	48:	9.9	←	49:	10.2	↗	50:	10.0	↓	<b>Series</b>		94 (1x)			462 (7x)	
31:	9.4	←																																																																									
32:	9.8	↗																																																																									
33:	9.2	↓																																																																									
34:	10.5x	↓																																																																									
35:	9.7	←																																																																									
36:	9.2	↓																																																																									
37:	9.9	↙																																																																									
38:	10.2	←																																																																									
39:	10.1	→																																																																									
40:	10.1	↗																																																																									
<b>Series</b>		94 (1x)																																																																									
		368 (6x)																																																																									
41:	9.9	↑																																																																									
42:	10.4x	↑																																																																									
43:	10.1	←																																																																									
44:	9.4	→																																																																									
45:	8.7	→																																																																									
46:	9.2	→																																																																									
47:	10.2	↙																																																																									
48:	9.9	←																																																																									
49:	10.2	↗																																																																									
50:	10.0	↓																																																																									
<b>Series</b>		94 (1x)																																																																									
		462 (7x)																																																																									
<b>60 Shots</b> 	<table border="1" style="width:100%; border-collapse: collapse;"> <tr><td>51:</td><td>9.5</td><td>↓</td></tr> <tr><td>52:</td><td>10.3</td><td>↗</td></tr> <tr><td>53:</td><td>9.3</td><td>↗</td></tr> <tr><td>54:</td><td>9.8</td><td>↗</td></tr> <tr><td>55:</td><td>9.5</td><td>→</td></tr> <tr><td>56:</td><td>9.2</td><td>↑</td></tr> <tr><td>57:</td><td>9.5</td><td>↗</td></tr> <tr><td>58:</td><td>8.8</td><td>→</td></tr> <tr><td>59:</td><td>8.9</td><td>→</td></tr> <tr><td>60:</td><td>10.8x</td><td>↓</td></tr> <tr><td colspan="2"><b>Series</b></td><td>90 (1x)</td></tr> <tr><td colspan="2"></td><td>552 (8x)</td></tr> </table>	51:	9.5	↓	52:	10.3	↗	53:	9.3	↗	54:	9.8	↗	55:	9.5	→	56:	9.2	↑	57:	9.5	↗	58:	8.8	→	59:	8.9	→	60:	10.8x	↓	<b>Series</b>		90 (1x)			552 (8x)																																						
51:	9.5	↓																																																																									
52:	10.3	↗																																																																									
53:	9.3	↗																																																																									
54:	9.8	↗																																																																									
55:	9.5	→																																																																									
56:	9.2	↑																																																																									
57:	9.5	↗																																																																									
58:	8.8	→																																																																									
59:	8.9	→																																																																									
60:	10.8x	↓																																																																									
<b>Series</b>		90 (1x)																																																																									
		552 (8x)																																																																									



Relay **1** Lane **19** **LE SIEUR Francis**

2023 SFC Pistol Nationals QC EX MP

15.07.2023 PN23AP-Q-1 Alberta Handgun Association

Comment Signature

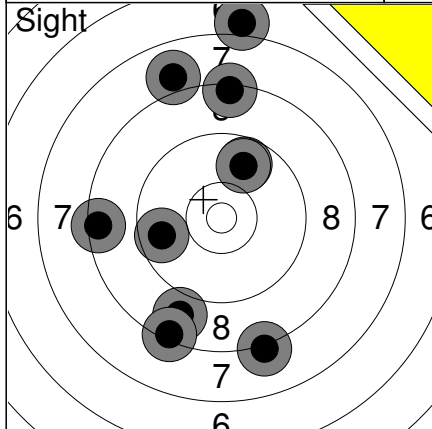

1:	8.8	↘
2:	9.8	↗
3:	7.0	↑
4:	8.4	↘
5:	8.4	↑
6:	9.7	←
7:	9.8	↗
8:	8.4	←
9:	7.9	↗
10:	8.2	↘
Series	81 (0x)	
	0 (0x)	

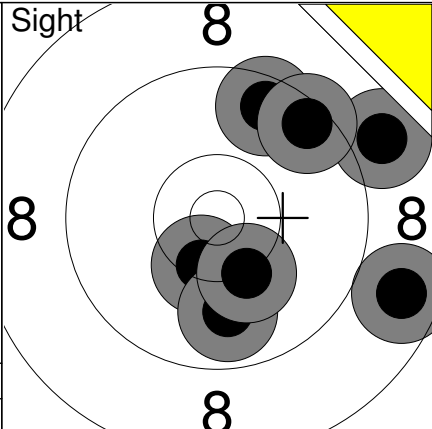

11:	8.9	↗
12:	10.4x	↘
13:	9.6	↗
14:	9.9	↘
15:	9.5	↗
16:	8.7	↘
17:	10.2	↘
Series	63 (1x)	
	0 (0x)	

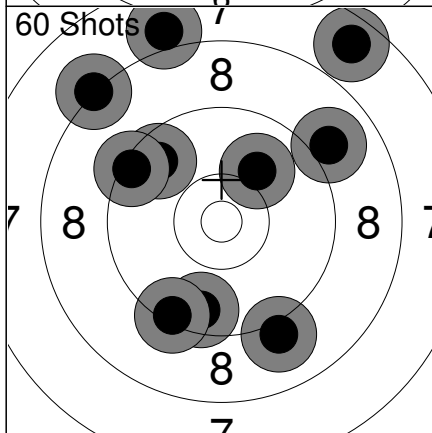

1:	7.6	↗
2:	9.6	↗
3:	9.6	↘
4:	8.0	↗
5:	8.2	↗
6:	9.4	↘
7:	9.0	↘
8:	9.0	↗
9:	9.4	↖
10:	10.0	↗
Series	87 (0x)	
	87 (0x)	

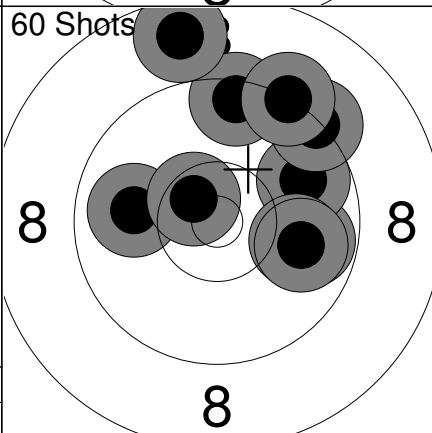

11:	9.8	→
12:	9.5	↑
13:	8.7	↑
14:	9.8	↗
15:	9.3	↗
16:	9.9	←
17:	9.2	↗
18:	10.6x	↗
19:	10.0	→
20:	9.9	→
Series	91 (1x)	
	178 (1x)	

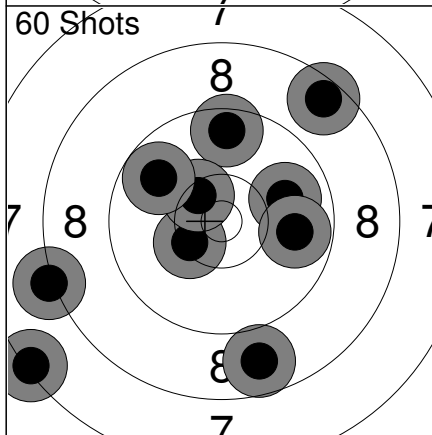

21:	7.3	↖
22:	9.6	↑
23:	10.4x	↖
24:	8.7	↘
25:	9.9	→
26:	10.4x	↗
27:	8.5	↗
28:	9.8	↗
29:	9.8	→
30:	8.2	←
Series	87 (2x)	
	265 (3x)	

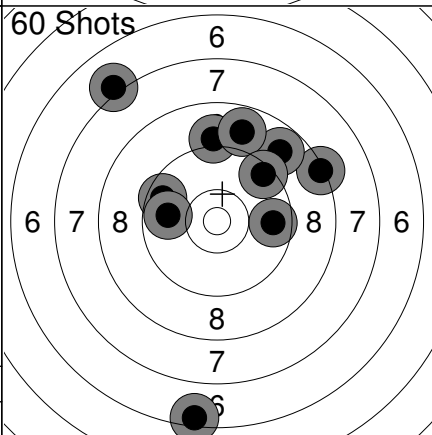

31:	8.3	↗
32:	6.4	↘
33:	7.1	↖
34:	9.1	↑
35:	9.6	←
36:	9.7	→
37:	8.8	↗
38:	9.8	←
39:	8.8	↑
40:	9.4	↗
Series	82 (0x)	
	347 (3x)	

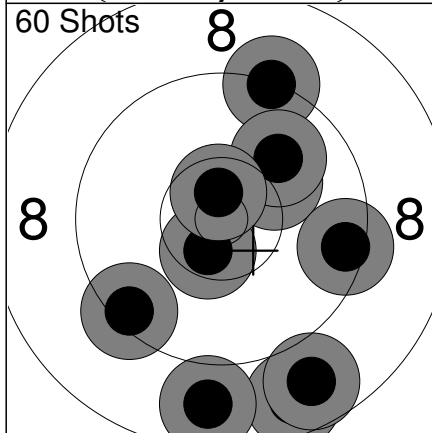

41:	9.4	↖
42:	9.3	↗
43:	10.2	↗
44:	9.4	→
45:	10.0	↗
46:	8.7	↘
47:	10.5x	↘
48:	8.8	↘
49:	10.6x	↑
50:	8.8	↘
Series	91 (2x)	
	438 (5x)	

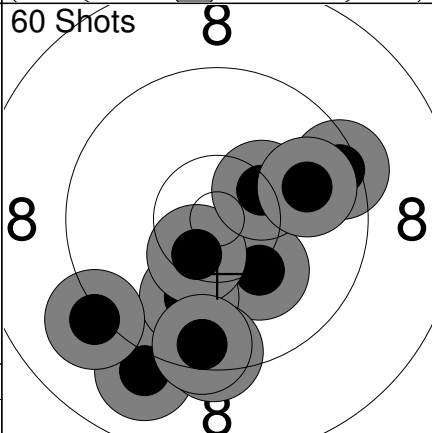

51:	10.2	↘
52:	9.0	↘
53:	10.0	↘
54:	9.1	←
55:	10.5x	↘
56:	9.4	↘
57:	9.5	↘
58:	10.3	↗
59:	9.4	↗
60:	9.9	↗
Series	94 (1x)	
	532 (6x)	

Relay <b>1</b>	Lane <b>20</b>	<b>MARKEWICZ Alan</b>
-------------------	-------------------	-----------------------

2023 SFC Pistol Nationals	AB	EX	MP
---------------------------	----	----	----

15.07.2023	PN23AP-Q-1	Alberta Handgun Association
------------	------------	-----------------------------

Comment	Signature
---------	-----------

	<table border="1" style="width:100%; border-collapse: collapse;"> <tr><td>1:</td><td>8.5</td><td>↓</td></tr> <tr><td>2:</td><td>7.8</td><td>↓</td></tr> <tr><td>3:</td><td>9.8</td><td>↗</td></tr> <tr><td>4:</td><td>9.8</td><td>→</td></tr> <tr><td>5:</td><td>7.5</td><td>↗</td></tr> <tr><td>6:</td><td>10.3</td><td>↗</td></tr> <tr><td>7:</td><td>9.1</td><td>↖</td></tr> <tr><td>8:</td><td>10.2</td><td>→</td></tr> <tr><td>9:</td><td>8.6</td><td>↖</td></tr> <tr><td>10:</td><td>7.8</td><td>↖</td></tr> <tr><td colspan="2">Series</td><td>84 (0x)</td></tr> <tr><td colspan="2"></td><td>0 (0x)</td></tr> </table>	1:	8.5	↓	2:	7.8	↓	3:	9.8	↗	4:	9.8	→	5:	7.5	↗	6:	10.3	↗	7:	9.1	↖	8:	10.2	→	9:	8.6	↖	10:	7.8	↖	Series		84 (0x)			0 (0x)		<table border="1" style="width:100%; border-collapse: collapse;"> <tr><td>11:</td><td>10.1</td><td>↗</td></tr> <tr><td colspan="2">Series</td><td>10 (0x)</td></tr> <tr><td colspan="2"></td><td>0 (0x)</td></tr> </table>	11:	10.1	↗	Series		10 (0x)			0 (0x)																											
1:	8.5	↓																																																																									
2:	7.8	↓																																																																									
3:	9.8	↗																																																																									
4:	9.8	→																																																																									
5:	7.5	↗																																																																									
6:	10.3	↗																																																																									
7:	9.1	↖																																																																									
8:	10.2	→																																																																									
9:	8.6	↖																																																																									
10:	7.8	↖																																																																									
Series		84 (0x)																																																																									
		0 (0x)																																																																									
11:	10.1	↗																																																																									
Series		10 (0x)																																																																									
		0 (0x)																																																																									
	<table border="1" style="width:100%; border-collapse: collapse;"> <tr><td>1:</td><td>10.2</td><td>↖</td></tr> <tr><td>2:</td><td>10.4x</td><td>↖</td></tr> <tr><td>3:</td><td>10.2</td><td>↖</td></tr> <tr><td>4:</td><td>10.5x</td><td>↖</td></tr> <tr><td>5:</td><td>9.4</td><td>↓</td></tr> <tr><td>6:</td><td>9.3</td><td>↗</td></tr> <tr><td>7:</td><td>8.6</td><td>↗</td></tr> <tr><td>8:</td><td>10.2</td><td>↗</td></tr> <tr><td>9:</td><td>10.0</td><td>↓</td></tr> <tr><td>10:</td><td>8.1</td><td>↖</td></tr> <tr><td colspan="2">Series</td><td>94 (2x)</td></tr> <tr><td colspan="2"></td><td>94 (2x)</td></tr> </table>	1:	10.2	↖	2:	10.4x	↖	3:	10.2	↖	4:	10.5x	↖	5:	9.4	↓	6:	9.3	↗	7:	8.6	↗	8:	10.2	↗	9:	10.0	↓	10:	8.1	↖	Series		94 (2x)			94 (2x)		<table border="1" style="width:100%; border-collapse: collapse;"> <tr><td>11:</td><td>9.9</td><td>↖</td></tr> <tr><td>12:</td><td>10.4x</td><td>↗</td></tr> <tr><td>13:</td><td>10.3</td><td>→</td></tr> <tr><td>14:</td><td>8.1</td><td>→</td></tr> <tr><td>15:</td><td>10.3</td><td>↓</td></tr> <tr><td>16:</td><td>9.6</td><td>↖</td></tr> <tr><td>17:</td><td>7.5</td><td>↗</td></tr> <tr><td>18:</td><td>8.9</td><td>→</td></tr> <tr><td>19:</td><td>8.5</td><td>↑</td></tr> <tr><td>20:</td><td>10.6x</td><td>↙</td></tr> <tr><td colspan="2">Series</td><td>89 (2x)</td></tr> <tr><td colspan="2"></td><td>183 (4x)</td></tr> </table>	11:	9.9	↖	12:	10.4x	↗	13:	10.3	→	14:	8.1	→	15:	10.3	↓	16:	9.6	↖	17:	7.5	↗	18:	8.9	→	19:	8.5	↑	20:	10.6x	↙	Series		89 (2x)			183 (4x)
1:	10.2	↖																																																																									
2:	10.4x	↖																																																																									
3:	10.2	↖																																																																									
4:	10.5x	↖																																																																									
5:	9.4	↓																																																																									
6:	9.3	↗																																																																									
7:	8.6	↗																																																																									
8:	10.2	↗																																																																									
9:	10.0	↓																																																																									
10:	8.1	↖																																																																									
Series		94 (2x)																																																																									
		94 (2x)																																																																									
11:	9.9	↖																																																																									
12:	10.4x	↗																																																																									
13:	10.3	→																																																																									
14:	8.1	→																																																																									
15:	10.3	↓																																																																									
16:	9.6	↖																																																																									
17:	7.5	↗																																																																									
18:	8.9	→																																																																									
19:	8.5	↑																																																																									
20:	10.6x	↙																																																																									
Series		89 (2x)																																																																									
		183 (4x)																																																																									
	<table border="1" style="width:100%; border-collapse: collapse;"> <tr><td>21:</td><td>7.9</td><td>→</td></tr> <tr><td>22:</td><td>10.0</td><td>↓</td></tr> <tr><td>23:</td><td>8.2</td><td>↑</td></tr> <tr><td>24:</td><td>9.1</td><td>↗</td></tr> <tr><td>25:</td><td>9.6</td><td>↗</td></tr> <tr><td>26:</td><td>9.1</td><td>↖</td></tr> <tr><td>27:</td><td>10.1</td><td>↑</td></tr> <tr><td>28:</td><td>9.5</td><td>↑</td></tr> <tr><td>29:</td><td>9.8</td><td>↖</td></tr> <tr><td>30:</td><td>9.1</td><td>↗</td></tr> <tr><td colspan="2">Series</td><td>89 (0x)</td></tr> <tr><td colspan="2"></td><td>272 (4x)</td></tr> </table>	21:	7.9	→	22:	10.0	↓	23:	8.2	↑	24:	9.1	↗	25:	9.6	↗	26:	9.1	↖	27:	10.1	↑	28:	9.5	↑	29:	9.8	↖	30:	9.1	↗	Series		89 (0x)			272 (4x)		<table border="1" style="width:100%; border-collapse: collapse;"> <tr><td>31:</td><td>9.9</td><td>↖</td></tr> <tr><td>32:</td><td>9.4</td><td>↙</td></tr> <tr><td>33:</td><td>8.8</td><td>↑</td></tr> <tr><td>34:</td><td>9.7</td><td>↓</td></tr> <tr><td>35:</td><td>9.4</td><td>↓</td></tr> <tr><td>36:</td><td>9.6</td><td>↖</td></tr> <tr><td>37:</td><td>9.2</td><td>↖</td></tr> <tr><td>38:</td><td>9.7</td><td>↓</td></tr> <tr><td>39:</td><td>9.0</td><td>↗</td></tr> <tr><td>40:</td><td>9.9</td><td>→</td></tr> <tr><td colspan="2">Series</td><td>89 (0x)</td></tr> <tr><td colspan="2"></td><td>361 (4x)</td></tr> </table>	31:	9.9	↖	32:	9.4	↙	33:	8.8	↑	34:	9.7	↓	35:	9.4	↓	36:	9.6	↖	37:	9.2	↖	38:	9.7	↓	39:	9.0	↗	40:	9.9	→	Series		89 (0x)			361 (4x)
21:	7.9	→																																																																									
22:	10.0	↓																																																																									
23:	8.2	↑																																																																									
24:	9.1	↗																																																																									
25:	9.6	↗																																																																									
26:	9.1	↖																																																																									
27:	10.1	↑																																																																									
28:	9.5	↑																																																																									
29:	9.8	↖																																																																									
30:	9.1	↗																																																																									
Series		89 (0x)																																																																									
		272 (4x)																																																																									
31:	9.9	↖																																																																									
32:	9.4	↙																																																																									
33:	8.8	↑																																																																									
34:	9.7	↓																																																																									
35:	9.4	↓																																																																									
36:	9.6	↖																																																																									
37:	9.2	↖																																																																									
38:	9.7	↓																																																																									
39:	9.0	↗																																																																									
40:	9.9	→																																																																									
Series		89 (0x)																																																																									
		361 (4x)																																																																									
	<table border="1" style="width:100%; border-collapse: collapse;"> <tr><td>41:</td><td>10.1</td><td>→</td></tr> <tr><td>42:</td><td>9.9</td><td>↓</td></tr> <tr><td>43:</td><td>9.2</td><td>↗</td></tr> <tr><td>44:</td><td>8.8</td><td>→</td></tr> <tr><td>45:</td><td>9.7</td><td>↑</td></tr> <tr><td>46:</td><td>8.9</td><td>↗</td></tr> <tr><td>47:</td><td>9.1</td><td>↖</td></tr> <tr><td>48:</td><td>8.3</td><td>→</td></tr> <tr><td>49:</td><td>9.3</td><td>↗</td></tr> <tr><td>50:</td><td>9.1</td><td>↑</td></tr> <tr><td colspan="2">Series</td><td>88 (0x)</td></tr> <tr><td colspan="2"></td><td>449 (4x)</td></tr> </table>	41:	10.1	→	42:	9.9	↓	43:	9.2	↗	44:	8.8	→	45:	9.7	↑	46:	8.9	↗	47:	9.1	↖	48:	8.3	→	49:	9.3	↗	50:	9.1	↑	Series		88 (0x)			449 (4x)		<table border="1" style="width:100%; border-collapse: collapse;"> <tr><td>51:</td><td>9.8</td><td>↖</td></tr> <tr><td>52:</td><td>10.7x</td><td>→</td></tr> <tr><td>53:</td><td>9.0</td><td>↓</td></tr> <tr><td>54:</td><td>9.4</td><td>↗</td></tr> <tr><td>55:</td><td>9.8</td><td>↓</td></tr> <tr><td>56:</td><td>8.4</td><td>↑</td></tr> <tr><td>57:</td><td>10.6x</td><td>→</td></tr> <tr><td>58:</td><td>9.4</td><td>↙</td></tr> <tr><td>59:</td><td>8.3</td><td>↓</td></tr> <tr><td>60:</td><td>9.3</td><td>↑</td></tr> <tr><td colspan="2">Series</td><td>90 (2x)</td></tr> <tr><td colspan="2"></td><td>539 (6x)</td></tr> </table>	51:	9.8	↖	52:	10.7x	→	53:	9.0	↓	54:	9.4	↗	55:	9.8	↓	56:	8.4	↑	57:	10.6x	→	58:	9.4	↙	59:	8.3	↓	60:	9.3	↑	Series		90 (2x)			539 (6x)
41:	10.1	→																																																																									
42:	9.9	↓																																																																									
43:	9.2	↗																																																																									
44:	8.8	→																																																																									
45:	9.7	↑																																																																									
46:	8.9	↗																																																																									
47:	9.1	↖																																																																									
48:	8.3	→																																																																									
49:	9.3	↗																																																																									
50:	9.1	↑																																																																									
Series		88 (0x)																																																																									
		449 (4x)																																																																									
51:	9.8	↖																																																																									
52:	10.7x	→																																																																									
53:	9.0	↓																																																																									
54:	9.4	↗																																																																									
55:	9.8	↓																																																																									
56:	8.4	↑																																																																									
57:	10.6x	→																																																																									
58:	9.4	↙																																																																									
59:	8.3	↓																																																																									
60:	9.3	↑																																																																									
Series		90 (2x)																																																																									
		539 (6x)																																																																									

Relay <b>1</b>	Lane <b>21</b>	<b>OZER Tugrul</b>
-------------------	-------------------	--------------------

2023 SFC Pistol Nationals	AB	MA	MP
---------------------------	----	----	----

15.07.2023	PN23AP-Q-1	Alberta Handgun Association
------------	------------	-----------------------------

Comment	Signature
---------	-----------

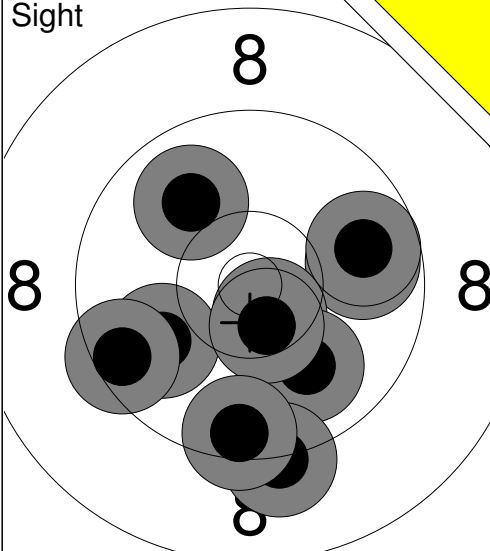
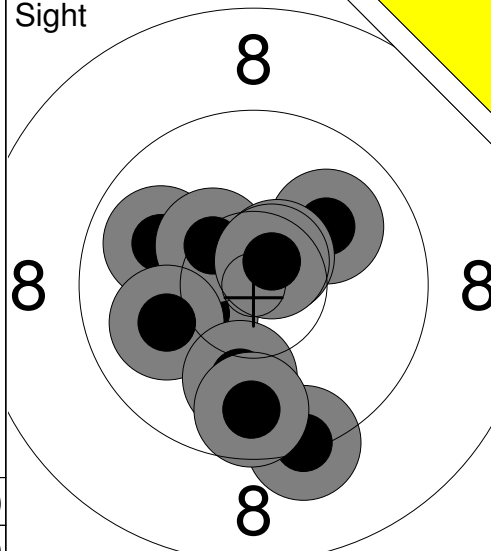
<p>Sight</p> 	<p>1: 9.8 → 2: 10.0 ↗ 3: 9.9 ← 4: 10.6x ↓ 5: 10.0 ↓ 6: 9.8 → 7: 9.5 ← 8: 10.5x ↓ 9: 9.2 ↓ 10: 9.5 ↓</p> <p>Series 94 ( 2x) 0 ( 0x)</p>	<p>Sight</p> 	<p>11: 9.9 ← 12: 10.4x ↙ 13: 9.3 ↓ 14: 10.4x ↖ 15: 10.0 ↗ 16: 10.0 ← 17: 10.0 ↓ 18: 9.7 ↓ 19: 10.6x ↗ 20: 10.7x ↗</p> <p>Series 97 ( 4x) 0 ( 0x)</p>
---	--	---	--

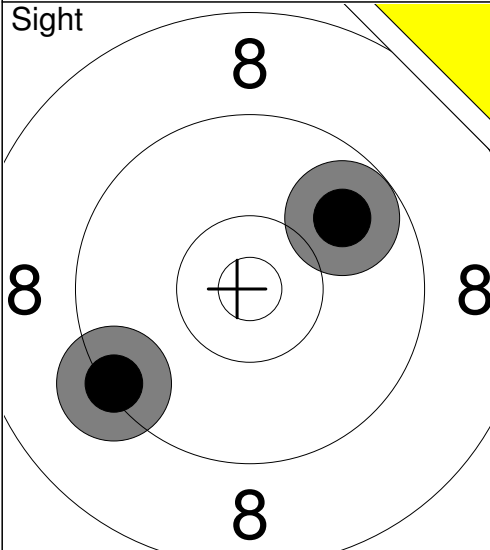
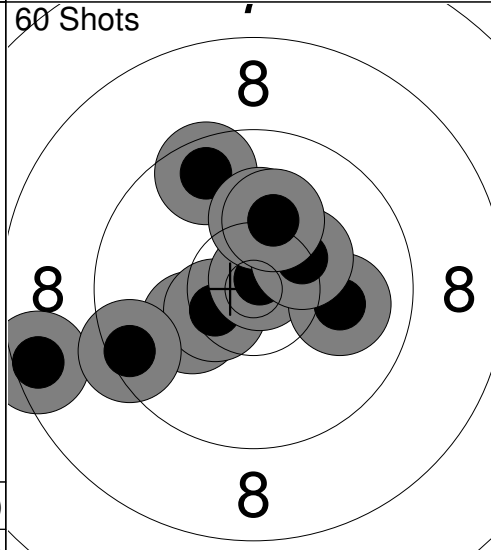
<p>Sight</p> 	<p>21: 9.3 ← 22: 9.8 →</p> <p>Series 18 ( 0x) 0 ( 0x)</p>	<p>60 Shots</p> 	<p>1: 10.2 ← 2: 10.5x ↙ 3: 9.6 ↑ 4: 10.8x ↗ 5: 8.5 ← 6: 10.2 ↑ 7: 9.5 ← 8: 10.0 → 9: 10.3 ↗ 10: 10.2 ↑</p> <p>Series 96 ( 2x) 96 ( 2x)</p>
--	---	---	--

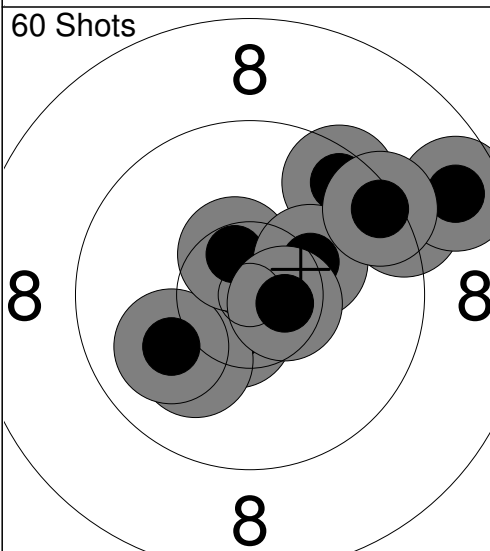
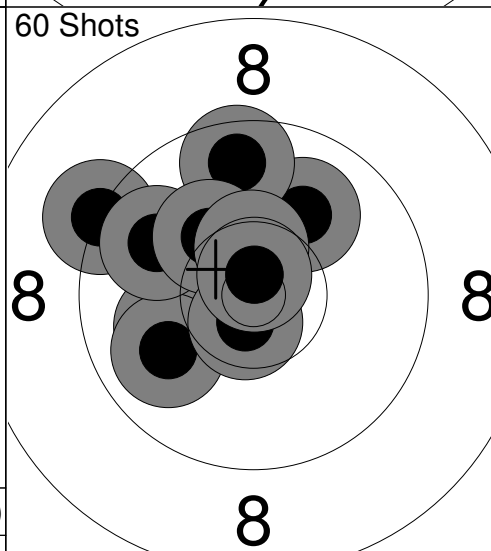
<p>60 Shots</p> 	<p>11: 10.6x ↓ 12: 9.3 → 13: 10.1 ↓ 14: 10.0 ← 15: 9.5 ↗ 16: 8.7 → 17: 10.5x ↑ 18: 10.3 → 19: 10.6x → 20: 9.4 →</p> <p>Series 95 ( 3x) 191 ( 5x)</p>	<p>60 Shots</p> 	<p>21: 10.0 ↗ 22: 10.1 ← 23: 9.9 ← 24: 9.3 ↖ 25: 9.6 ↑ 26: 9.9 ↖ 27: 10.2 ↖ 28: 10.5x ↑ 29: 10.7x ↓ 30: 10.7x ↑</p> <p>Series 96 ( 3x) 287 ( 8x)</p>
--	--	--	--

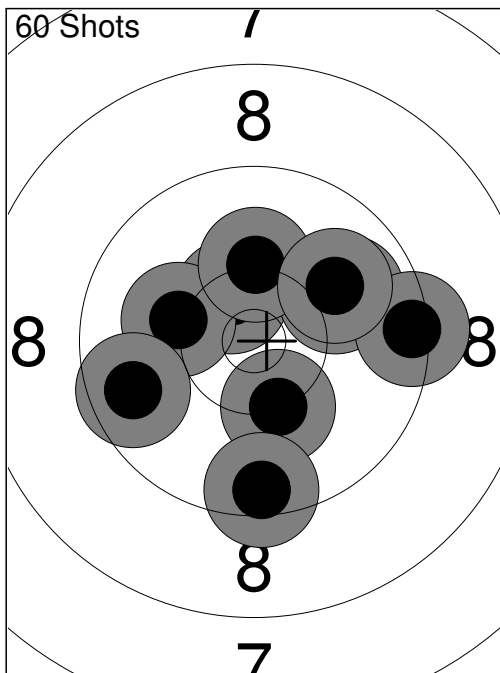

31:	10.3	↘
32:	9.9	↗
33:	10.5x	↖
34:	10.2	←
35:	9.7	←
36:	10.0	↗
37:	10.2	↑
38:	9.4	→
39:	9.5	↓
40:	10.0	↗
Series	96 ( 1x)	
	383 ( 9x)	

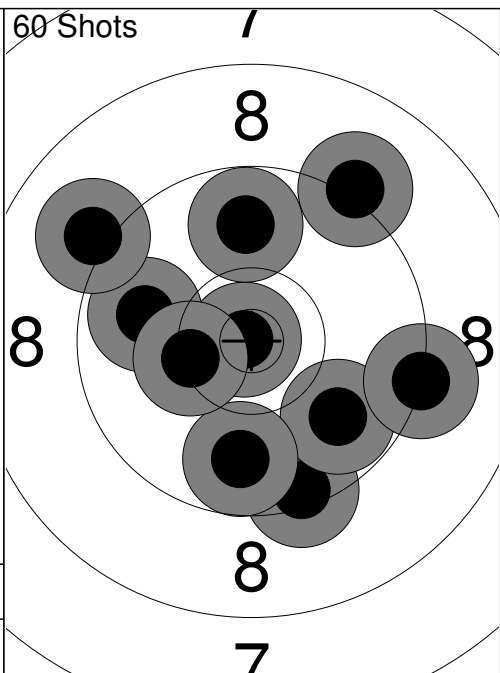

41:	10.9x	↙
42:	9.4	↓
43:	9.8	↘
44:	9.8	↓
45:	9.1	↗
46:	9.2	→
47:	9.9	←
48:	9.1	↖
49:	10.3	←
50:	9.8	↑
Series	92 ( 1x)	
	475 (10x)	

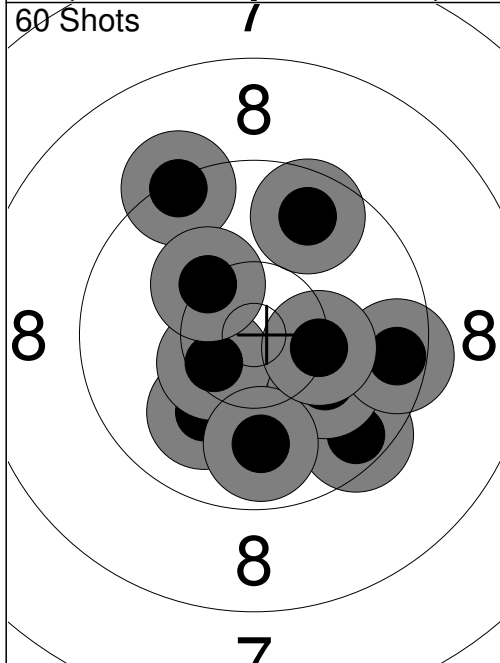

51:	10.0	↘
52:	9.5	↘
53:	9.7	↗
54:	10.1	↘
55:	10.5x	↙
56:	9.3	↗
57:	9.9	↓
58:	9.5	→
59:	10.3	→
60:	10.3	↖
Series	95 ( 1x)	
	570 (11x)	

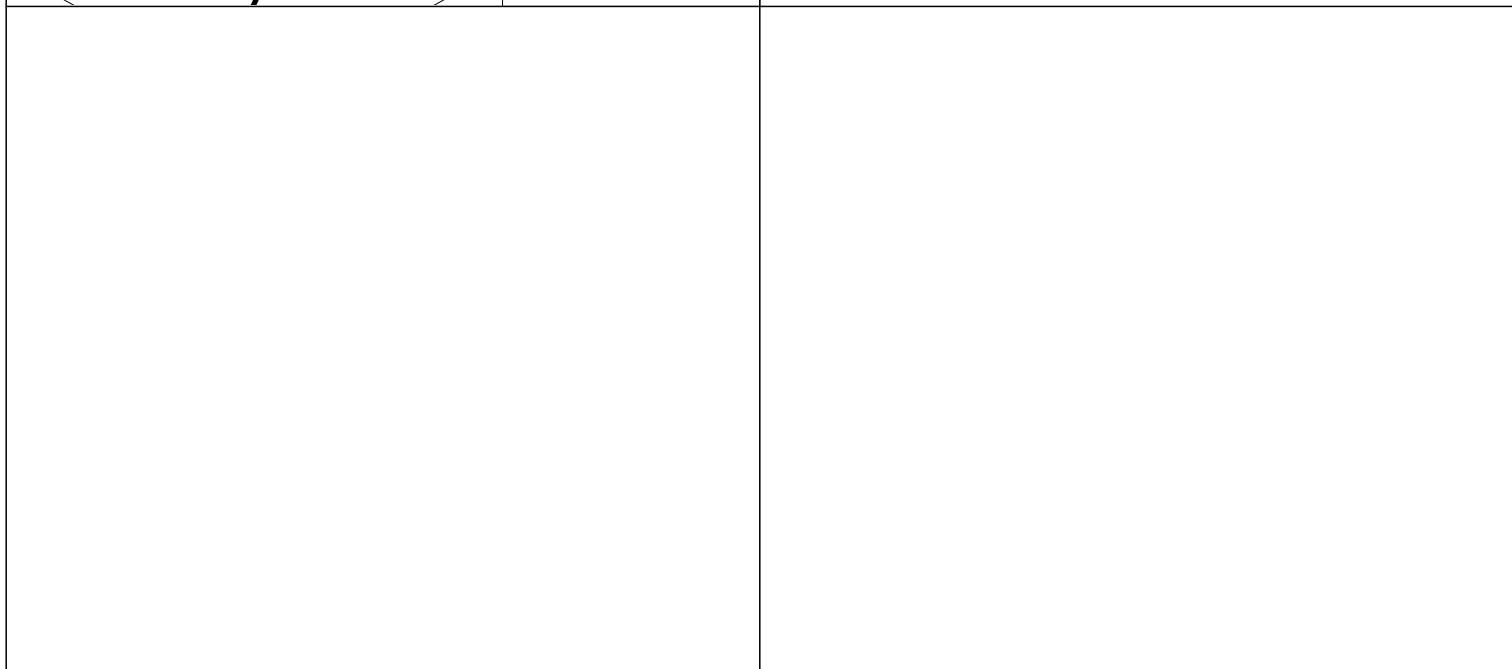

Relay <b>1</b>	Lane <b>22</b>	<b>KOZIC Igor</b>
-------------------	-------------------	-------------------

2023 SFC Pistol Nationals	ON	MA	MP
---------------------------	----	----	----

15.07.2023	PN23AP-Q-1	Alberta Handgun Association
------------	------------	-----------------------------

Comment	Signature
---------	-----------

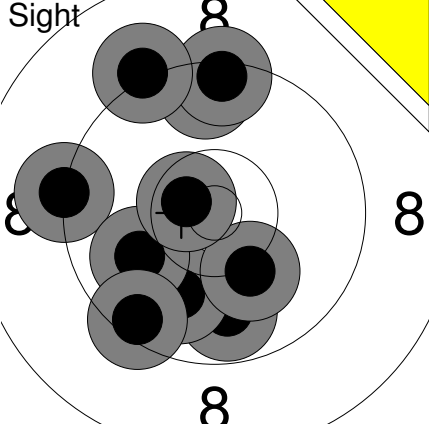
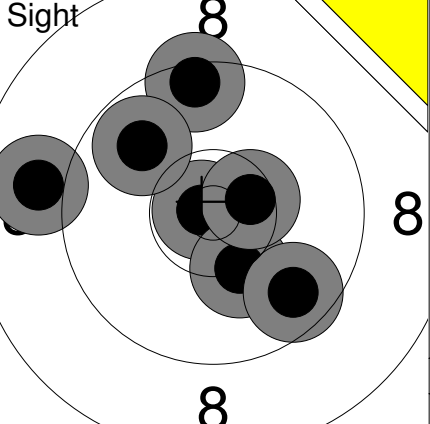
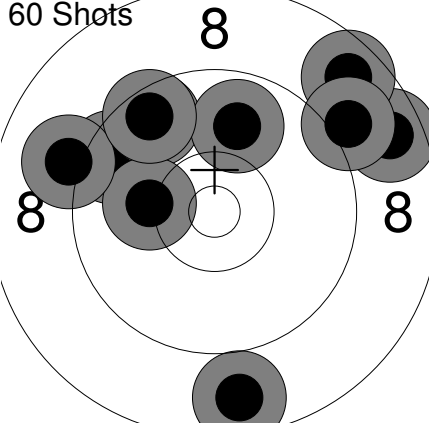
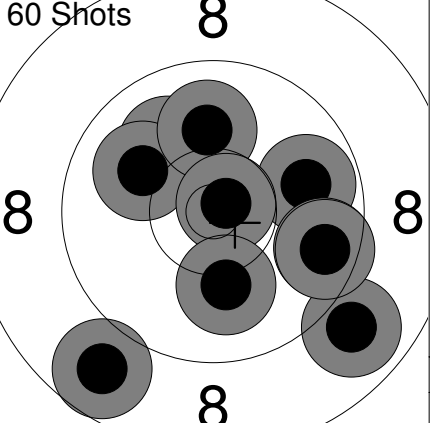
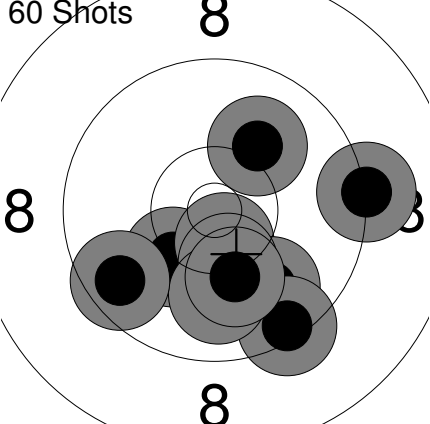
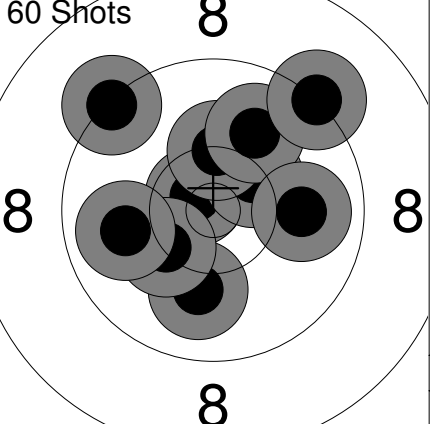
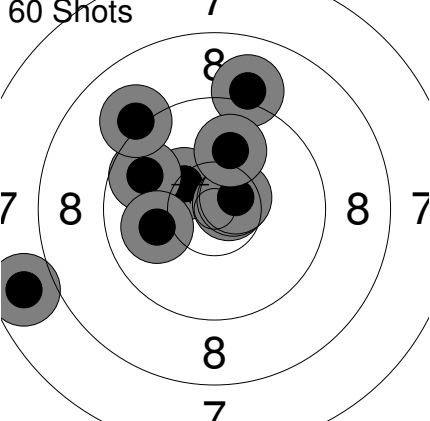
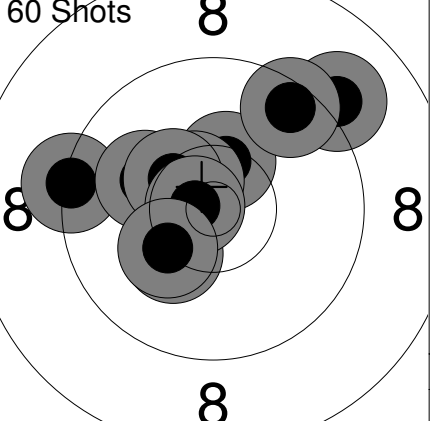
	1: 9.8 ↓ 2: 10.0 ↓ 3: 9.2 ← 4: 9.5 ↑ 5: 10.0 ← 6: 9.4 ↑ 7: 9.2 ↗ 8: 10.2 ↓ 9: 10.6x ↗ 10: 9.5 ↓		11: 10.8x ← 12: 8.9 ← 13: 9.4 ↑ 14: 10.3 ↓ 15: 9.8 ↗ 16: 9.7 ↓ 17: 10.5x →
	Series 94 (1x) 0 (0x)		Series 65 (2x) 0 (0x)
	1: 9.6 ← 2: 9.6 ↗ 3: 10.2 ← 4: 9.9 ↑ 5: 9.1 ← 6: 8.7 ↓ 7: 9.6 ↗ 8: 8.6 → 9: 8.7 ↗ 10: 9.0 ↗		11: 9.9 → 12: 10.0 ↗ 13: 10.0 ↗ 14: 10.0 ↑ 15: 10.8x ↗ 16: 8.9 ↓ 17: 9.6 → 18: 10.1 ↓ 19: 8.8 ↓ 20: 9.6 →
	Series 88 (0x) 88 (0x)		Series 93 (1x) 181 (1x)
	21: 10.2 ↓ 22: 9.2 → 23: 10.6x ↓ 24: 9.9 ↓ 25: 9.4 ↓ 26: 10.3 ↓ 27: 10.0 ↓ 28: 10.2 ↓ 29: 10.1 ↗ 30: 9.6 ←		31: 10.7x ← 32: 10.4x ↗ 33: 10.3 ↑ 34: 10.0 ↑ 35: 9.2 ↗ 36: 9.3 ↗ 37: 10.0 ↓ 38: 10.3 ← 39: 9.9 → 40: 9.9 ←
	Series 96 (1x) 277 (2x)		Series 96 (2x) 373 (4x)
	41: 9.1 ↑ 42: 10.3 ↗ 43: 7.7 ← 44: 9.8 ← 45: 10.7x → 46: 9.1 ↗ 47: 10.6x → 48: 10.6x → 49: 10.0 ↑ 50: 10.0 ←		51: 10.3 ↓ 52: 9.3 ← 53: 10.4x ↑ 54: 10.1 ← 55: 10.6x ↗ 56: 10.4x ↗ 57: 9.1 ↗ 58: 9.5 ↗ 59: 10.7x ← 60: 10.3 ↓
	Series 94 (3x) 467 (7x)		Series 97 (4x) 564 (11x)



Relay <b>1</b>	Lane <b>23</b>	<b>HYNES Mark</b>			
-------------------	-------------------	-------------------	--	--	--

2023 SFC Pistol Nationals	ON	MA	MP
---------------------------	----	----	----

15.07.2023	PN23AP-Q-1	Alberta Handgun Association
------------	------------	-----------------------------

Comment	Signature
---------	-----------

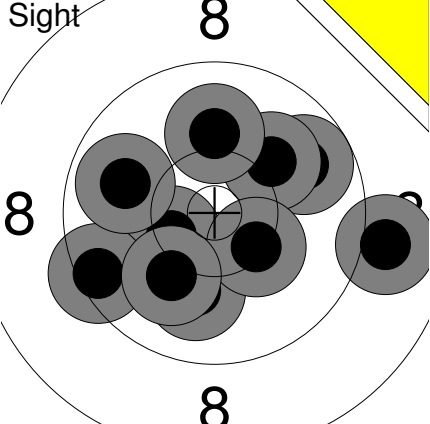
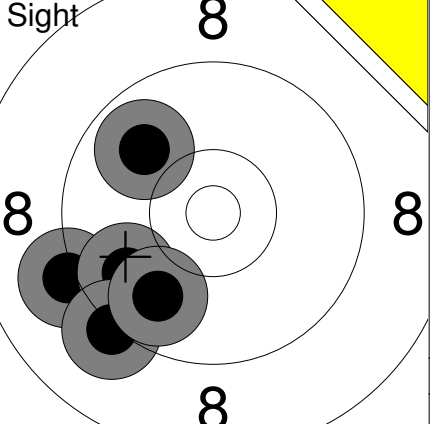
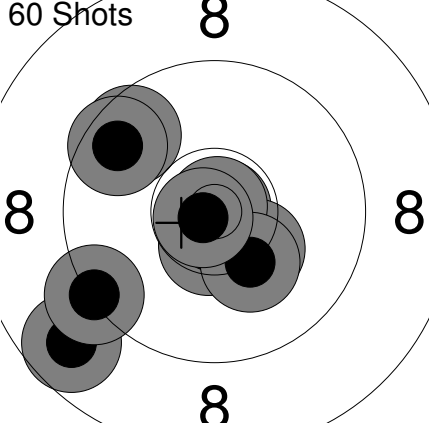
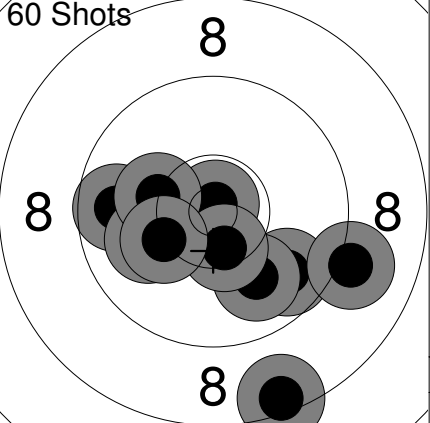
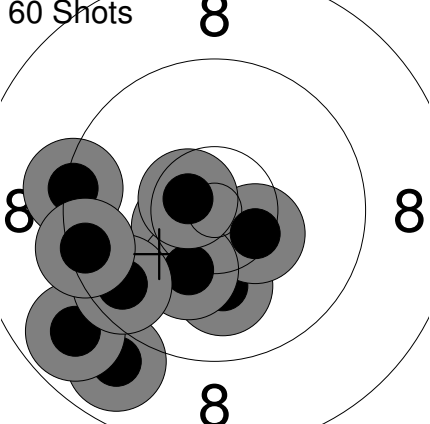
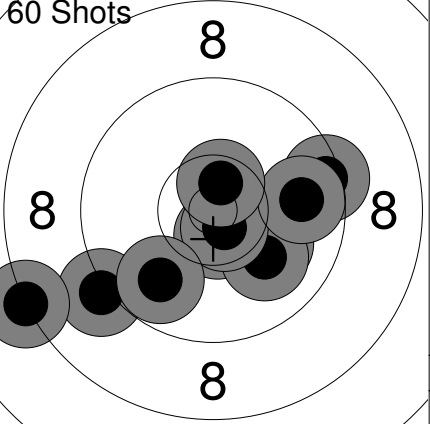
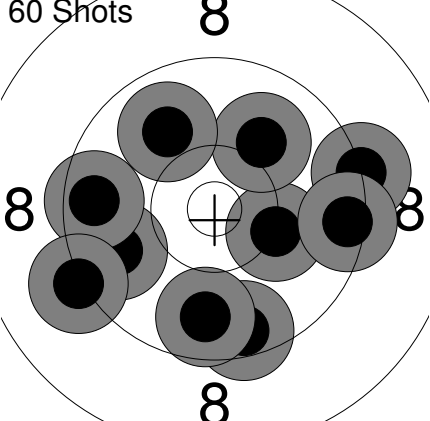
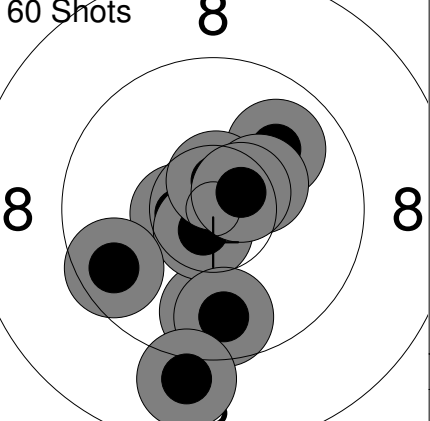
Sight 	1: 10.0 ↓	Sight 	11: 9.9 ↖
	2: 9.0 →		12: 9.1 ←
	3: 10.4x ←		13: 9.8 ←
	4: 9.8 →		14: 9.2 ↙
	5: 10.1 ↗		15: 9.8 ↘
	6: 10.3 ↓		
	7: 9.5 ←		
	8: 10.1 ↑		
	9: 10.1 ↓		
	10: 9.9 ←		
	Series 96 (1x)		Series 45 (0x)
	0 (0x)		0 (0x)
60 Shots 	1: 8.7 ↙	60 Shots 	11: 10.9x ↑
	2: 10.9x →		12: 9.7 ↘
	3: 9.7 ↗		13: 8.4 ↓
	4: 9.6 ↗		14: 9.7 ←
	5: 10.3 ↓		15: 10.0 ↓
	6: 10.6x ↓		16: 9.1 →
	7: 10.9x ↗		17: 10.1 ←
	8: 10.2 ↓		18: 10.2 ←
	9: 10.8x ←		19: 10.5x ↓
	10: 9.3 ↙		20: 10.2 ↙
	Series 95 (4x)		Series 95 (2x)
	95 (4x)		190 (6x)
60 Shots 	21: 8.9 ↓	60 Shots 	31: 10.6x ↓
	22: 10.1 ↓		32: 9.1 ↙
	23: 9.3 ←		33: 9.4 →
	24: 10.5x ←		34: 10.1 ↘
	25: 10.4x ↘		35: 10.0 ↓
	26: 10.2 ↓		36: 10.7x ↓
	27: 8.8 ↙		37: 9.8 ↙
	28: 9.6 ←		38: 8.2 ←
	29: 10.6x ↖		39: 9.8 →
	30: 9.4 ←		40: 10.6x ↑
	Series 93 (3x)		Series 94 (3x)
	283 (9x)		377 (12x)
60 Shots 	41: 9.8 ←	60 Shots 	51: 9.8 ↓
	42: 9.6 ←		52: 10.6x ←
	43: 10.2 →		53: 10.0 ↗
	44: 9.5 ↓		54: 10.7x ↓
	45: 10.0 ↗		55: 9.6 ←
	46: 9.9 ↗		56: 10.6x ↑
	47: 9.2 →		57: 9.7 ↓
	48: 9.7 ↓		58: 10.4x →
	49: 9.2 ←		59: 9.0 ↓
	50: 9.4 →		60: 10.6x ↗
	Series 92 (0x)		Series 96 (5x)
	469 (12x)		565 (17x)

<b>Relay</b> 1	<b>Lane</b> 24	<b>SHAWN Richard</b>
-------------------	-------------------	----------------------

2023 SFC Pistol Nationals	BC	MA	MP
---------------------------	----	----	----

15.07.2023	PN23AP-Q-1	Alberta Handgun Association
------------	------------	-----------------------------

Comment	Signature
---------	-----------

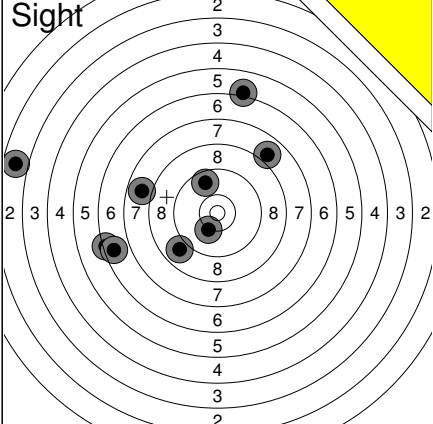
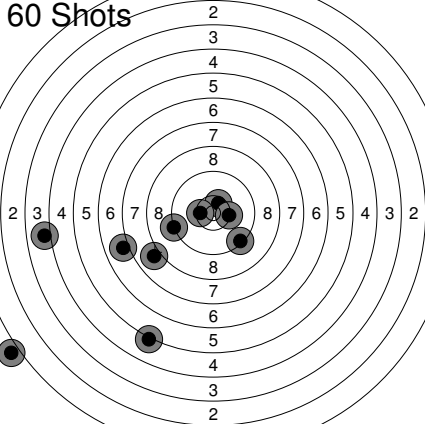
<b>Sight</b> 	<table border="1" style="width:100%; border-collapse: collapse;"> <tr><td>1:</td><td>7.9</td><td>↗</td></tr> <tr><td>2:</td><td>6.3</td><td>←</td></tr> <tr><td>3:</td><td>7.8</td><td>←</td></tr> <tr><td>4:</td><td>9.6</td><td>↗</td></tr> <tr><td>5:</td><td>2.7</td><td>←</td></tr> <tr><td>6:</td><td>6.1</td><td>↑</td></tr> <tr><td>7:</td><td>8.9</td><td>↙</td></tr> <tr><td>8:</td><td>10.2</td><td>↘</td></tr> <tr><td>9:</td><td>6.6</td><td>←</td></tr> <tr><td colspan="2"><b>Series</b></td><td>61 (0x)</td></tr> <tr><td colspan="2"></td><td>0 (0x)</td></tr> </table>	1:	7.9	↗	2:	6.3	←	3:	7.8	←	4:	9.6	↗	5:	2.7	←	6:	6.1	↑	7:	8.9	↙	8:	10.2	↘	9:	6.6	←	<b>Series</b>		61 (0x)			0 (0x)	<b>60 Shots</b> 	<table border="1" style="width:100%; border-collapse: collapse;"> <tr><td>1:</td><td>5.2</td><td>↘</td></tr> <tr><td>2:</td><td>9.3</td><td>↘</td></tr> <tr><td>3:</td><td>10.5x</td><td>↗</td></tr> <tr><td>4:</td><td>9.2</td><td>←</td></tr> <tr><td>5:</td><td>0.0</td><td>↙</td></tr> <tr><td>6:</td><td>10.4x</td><td>←</td></tr> <tr><td>7:</td><td>7.0</td><td>←</td></tr> <tr><td>8:</td><td>7.9</td><td>↙</td></tr> <tr><td>9:</td><td>10.3</td><td>→</td></tr> <tr><td>10:</td><td>4.0</td><td>←</td></tr> <tr><td colspan="2"><b>Series</b></td><td>71 (2x)</td></tr> <tr><td colspan="2"></td><td>71 (2x)</td></tr> </table>	1:	5.2	↘	2:	9.3	↘	3:	10.5x	↗	4:	9.2	←	5:	0.0	↙	6:	10.4x	←	7:	7.0	←	8:	7.9	↙	9:	10.3	→	10:	4.0	←	<b>Series</b>		71 (2x)			71 (2x)
1:	7.9	↗																																																																						
2:	6.3	←																																																																						
3:	7.8	←																																																																						
4:	9.6	↗																																																																						
5:	2.7	←																																																																						
6:	6.1	↑																																																																						
7:	8.9	↙																																																																						
8:	10.2	↘																																																																						
9:	6.6	←																																																																						
<b>Series</b>		61 (0x)																																																																						
		0 (0x)																																																																						
1:	5.2	↘																																																																						
2:	9.3	↘																																																																						
3:	10.5x	↗																																																																						
4:	9.2	←																																																																						
5:	0.0	↙																																																																						
6:	10.4x	←																																																																						
7:	7.0	←																																																																						
8:	7.9	↙																																																																						
9:	10.3	→																																																																						
10:	4.0	←																																																																						
<b>Series</b>		71 (2x)																																																																						
		71 (2x)																																																																						

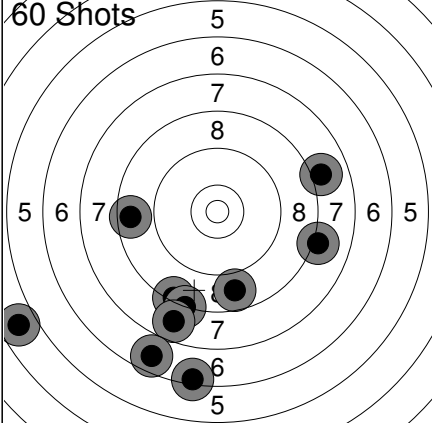
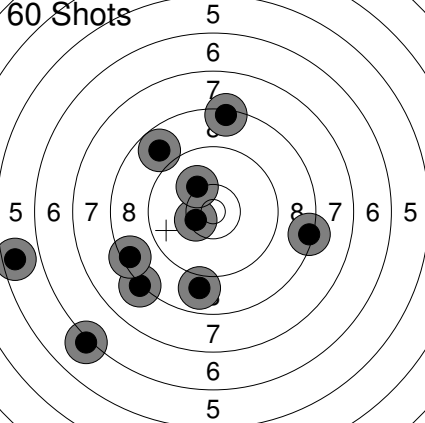
<b>60 Shots</b> 	<table border="1" style="width:100%; border-collapse: collapse;"> <tr><td>11:</td><td>8.3</td><td>↘</td></tr> <tr><td>12:</td><td>4.8</td><td>←</td></tr> <tr><td>13:</td><td>8.6</td><td>←</td></tr> <tr><td>14:</td><td>8.1</td><td>→</td></tr> <tr><td>15:</td><td>6.4</td><td>↘</td></tr> <tr><td>16:</td><td>8.8</td><td>↘</td></tr> <tr><td>17:</td><td>8.2</td><td>↘</td></tr> <tr><td>18:</td><td>8.0</td><td>→</td></tr> <tr><td>19:</td><td>7.8</td><td>↘</td></tr> <tr><td>20:</td><td>6.7</td><td>↘</td></tr> <tr><td colspan="2"><b>Series</b></td><td>71 (0x)</td></tr> <tr><td colspan="2"></td><td>142 (2x)</td></tr> </table>	11:	8.3	↘	12:	4.8	←	13:	8.6	←	14:	8.1	→	15:	6.4	↘	16:	8.8	↘	17:	8.2	↘	18:	8.0	→	19:	7.8	↘	20:	6.7	↘	<b>Series</b>		71 (0x)			142 (2x)	<b>60 Shots</b> 	<table border="1" style="width:100%; border-collapse: collapse;"> <tr><td>21:</td><td>8.9</td><td>↘</td></tr> <tr><td>22:</td><td>8.8</td><td>↖</td></tr> <tr><td>23:</td><td>10.4x</td><td>←</td></tr> <tr><td>24:</td><td>8.2</td><td>↙</td></tr> <tr><td>25:</td><td>10.2</td><td>↗</td></tr> <tr><td>26:</td><td>8.3</td><td>→</td></tr> <tr><td>27:</td><td>5.5</td><td>←</td></tr> <tr><td>28:</td><td>8.4</td><td>←</td></tr> <tr><td>29:</td><td>8.4</td><td>↑</td></tr> <tr><td>30:</td><td>6.1</td><td>↙</td></tr> <tr><td colspan="2"><b>Series</b></td><td>79 (1x)</td></tr> <tr><td colspan="2"></td><td>221 (3x)</td></tr> </table>	21:	8.9	↘	22:	8.8	↖	23:	10.4x	←	24:	8.2	↙	25:	10.2	↗	26:	8.3	→	27:	5.5	←	28:	8.4	←	29:	8.4	↑	30:	6.1	↙	<b>Series</b>		79 (1x)			221 (3x)
11:	8.3	↘																																																																									
12:	4.8	←																																																																									
13:	8.6	←																																																																									
14:	8.1	→																																																																									
15:	6.4	↘																																																																									
16:	8.8	↘																																																																									
17:	8.2	↘																																																																									
18:	8.0	→																																																																									
19:	7.8	↘																																																																									
20:	6.7	↘																																																																									
<b>Series</b>		71 (0x)																																																																									
		142 (2x)																																																																									
21:	8.9	↘																																																																									
22:	8.8	↖																																																																									
23:	10.4x	←																																																																									
24:	8.2	↙																																																																									
25:	10.2	↗																																																																									
26:	8.3	→																																																																									
27:	5.5	←																																																																									
28:	8.4	←																																																																									
29:	8.4	↑																																																																									
30:	6.1	↙																																																																									
<b>Series</b>		79 (1x)																																																																									
		221 (3x)																																																																									

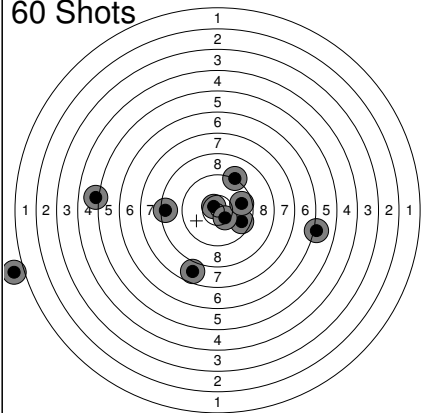
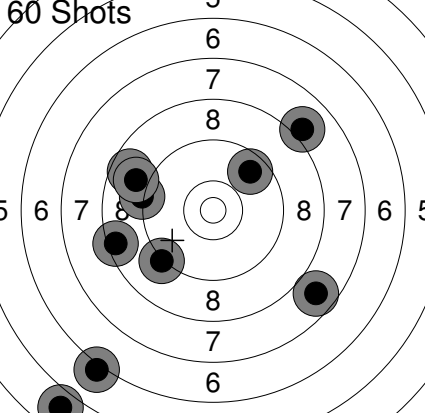
<b>60 Shots</b> 	<table border="1" style="width:100%; border-collapse: collapse;"> <tr><td>31:</td><td>0.0</td><td>←</td></tr> <tr><td>32:</td><td>6.1</td><td>→</td></tr> <tr><td>33:</td><td>7.8</td><td>↘</td></tr> <tr><td>34:</td><td>10.7x</td><td>↗</td></tr> <tr><td>35:</td><td>9.7</td><td>→</td></tr> <tr><td>36:</td><td>5.1</td><td>←</td></tr> <tr><td>37:</td><td>10.4x</td><td>↘</td></tr> <tr><td>38:</td><td>9.7</td><td>→</td></tr> <tr><td>39:</td><td>9.2</td><td>↗</td></tr> <tr><td>40:</td><td>8.4</td><td>←</td></tr> <tr><td colspan="2"><b>Series</b></td><td>73 (2x)</td></tr> <tr><td colspan="2"></td><td>294 (5x)</td></tr> </table>	31:	0.0	←	32:	6.1	→	33:	7.8	↘	34:	10.7x	↗	35:	9.7	→	36:	5.1	←	37:	10.4x	↘	38:	9.7	→	39:	9.2	↗	40:	8.4	←	<b>Series</b>		73 (2x)			294 (5x)	<b>60 Shots</b> 	<table border="1" style="width:100%; border-collapse: collapse;"> <tr><td>41:</td><td>8.4</td><td>←</td></tr> <tr><td>42:</td><td>9.2</td><td>←</td></tr> <tr><td>43:</td><td>9.6</td><td>↗</td></tr> <tr><td>44:</td><td>8.7</td><td>↖</td></tr> <tr><td>45:</td><td>8.0</td><td>↗</td></tr> <tr><td>46:</td><td>4.8</td><td>↙</td></tr> <tr><td>47:</td><td>9.2</td><td>↙</td></tr> <tr><td>48:</td><td>6.1</td><td>↙</td></tr> <tr><td>49:</td><td>7.7</td><td>↘</td></tr> <tr><td>50:</td><td>8.9</td><td>↖</td></tr> <tr><td colspan="2"><b>Series</b></td><td>76 (0x)</td></tr> <tr><td colspan="2"></td><td>370 (5x)</td></tr> </table>	41:	8.4	←	42:	9.2	←	43:	9.6	↗	44:	8.7	↖	45:	8.0	↗	46:	4.8	↙	47:	9.2	↙	48:	6.1	↙	49:	7.7	↘	50:	8.9	↖	<b>Series</b>		76 (0x)			370 (5x)
31:	0.0	←																																																																									
32:	6.1	→																																																																									
33:	7.8	↘																																																																									
34:	10.7x	↗																																																																									
35:	9.7	→																																																																									
36:	5.1	←																																																																									
37:	10.4x	↘																																																																									
38:	9.7	→																																																																									
39:	9.2	↗																																																																									
40:	8.4	←																																																																									
<b>Series</b>		73 (2x)																																																																									
		294 (5x)																																																																									
41:	8.4	←																																																																									
42:	9.2	←																																																																									
43:	9.6	↗																																																																									
44:	8.7	↖																																																																									
45:	8.0	↗																																																																									
46:	4.8	↙																																																																									
47:	9.2	↙																																																																									
48:	6.1	↙																																																																									
49:	7.7	↘																																																																									
50:	8.9	↖																																																																									
<b>Series</b>		76 (0x)																																																																									
		370 (5x)																																																																									

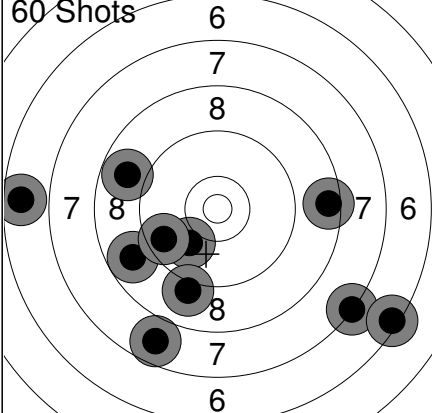
<b>60 Shots</b> 	<table border="1" style="width:100%; border-collapse: collapse;"> <tr><td>51:</td><td>7.2</td><td>→</td></tr> <tr><td>52:</td><td>8.8</td><td>←</td></tr> <tr><td>53:</td><td>6.4</td><td>→</td></tr> <tr><td>54:</td><td>10.0</td><td>↙</td></tr> <tr><td>55:</td><td>6.6</td><td>←</td></tr> <tr><td>56:</td><td>7.7</td><td>↘</td></tr> <tr><td>57:</td><td>9.0</td><td>↘</td></tr> <tr><td>58:</td><td>8.8</td><td>←</td></tr> <tr><td>59:</td><td>8.5</td><td>→</td></tr> <tr><td>60:</td><td>9.6</td><td>←</td></tr> <tr><td colspan="2"><b>Series</b></td><td>78 (0x)</td></tr> <tr><td colspan="2"></td><td>448 (5x)</td></tr> </table>	51:	7.2	→	52:	8.8	←	53:	6.4	→	54:	10.0	↙	55:	6.6	←	56:	7.7	↘	57:	9.0	↘	58:	8.8	←	59:	8.5	→	60:	9.6	←	<b>Series</b>		78 (0x)			448 (5x)		
51:	7.2	→																																					
52:	8.8	←																																					
53:	6.4	→																																					
54:	10.0	↙																																					
55:	6.6	←																																					
56:	7.7	↘																																					
57:	9.0	↘																																					
58:	8.8	←																																					
59:	8.5	→																																					
60:	9.6	←																																					
<b>Series</b>		78 (0x)																																					
		448 (5x)																																					

Relay **1** Lane **26** **WICK Werner**

2023 SFC Pistol Nationals AB MA MP

15.07.2023 PN23AP-Q-1 Alberta Handgun Association

Comment Signature

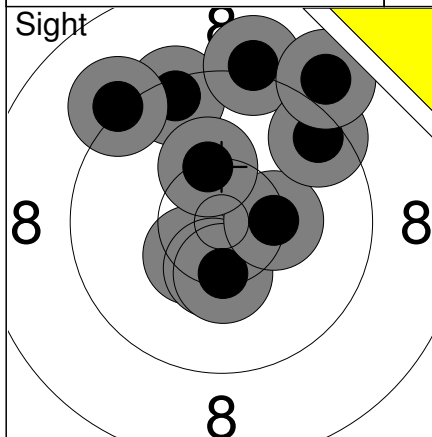

1:	9.4	↑
2:	10.5x	↙
3:	9.1	↑
4:	10.4x	↓
5:	10.4x	↓
6:	10.4x	→
7:	9.5	↗
8:	8.9	↗
9:	10.3	↑
10:	9.2	↖
Series	94 (4x)	
	0 (0x)	

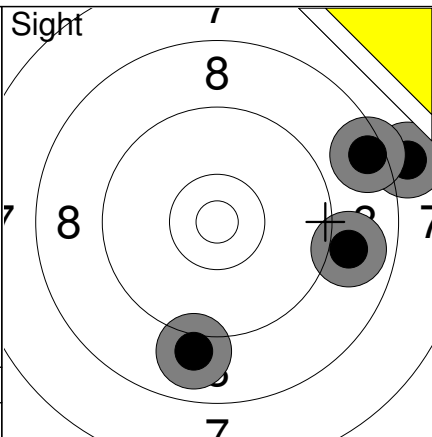

11:	9.0	↓
12:	7.9	→
13:	8.9	→
14:	8.5	→
Series	32 (0x)	
	0 (0x)	

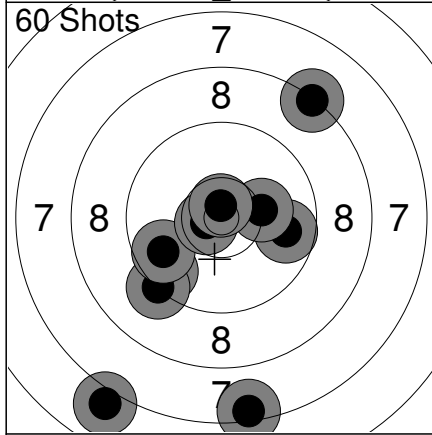

1:	9.6	↙
2:	9.8	→
3:	10.2	→
4:	7.4	↓
5:	9.2	↙
6:	8.3	↗
7:	9.7	↙
8:	7.0	↓
9:	10.7x	←
10:	10.7x	↑
Series	88 (2x)	
	88 (2x)	

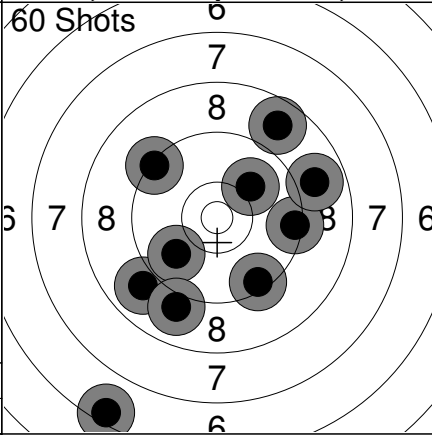

11:	9.4	↓
12:	6.4	↙
13:	9.4	→
14:	9.3	↗
15:	8.9	↙
16:	10.0	↗
17:	8.7	↗
18:	9.9	↙
19:	9.0	↓
20:	8.9	→
Series	85 (0x)	
	173 (2x)	

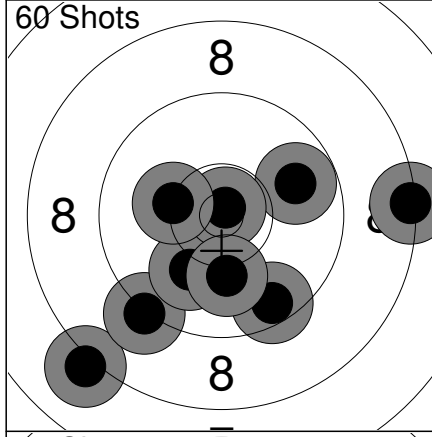

21:	8.1	↙
22:	9.8	→
23:	9.2	↙
24:	10.9x	↗
25:	9.5	↓
26:	10.1	↙
27:	10.8x	↗
28:	10.2	←
29:	10.1	↓
30:	8.3	→
Series	93 (2x)	
	266 (4x)	

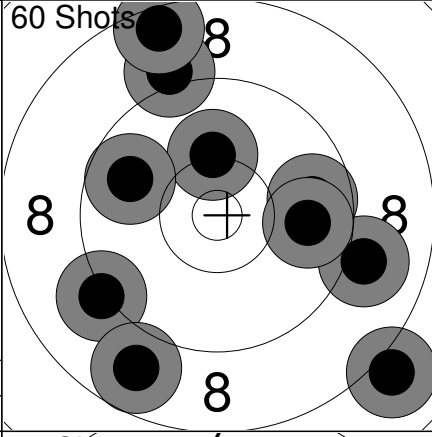

31:	9.0	→
32:	10.2	↑
33:	9.8	↖
34:	9.2	↙
35:	9.1	↑
36:	8.5	↑
37:	9.7	→
38:	8.0	↘
39:	8.8	↓
40:	9.8	→
Series	88 (0x)	
	354 (4x)	

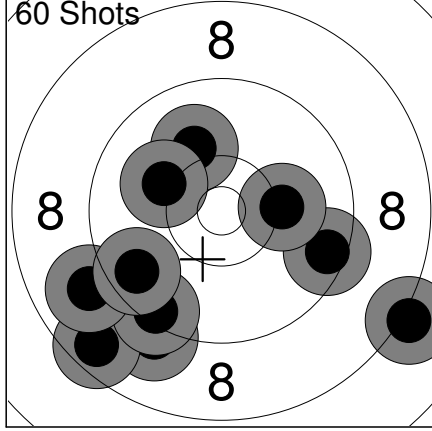

41:	9.1	↘
42:	8.6	↙
43:	9.5	→
44:	9.4	↙
45:	10.1	↗
46:	8.1	↘
47:	10.2	→
48:	10.1	↖
49:	9.0	↙
50:	9.6	↙
Series	91 (0x)	
	445 (4x)	

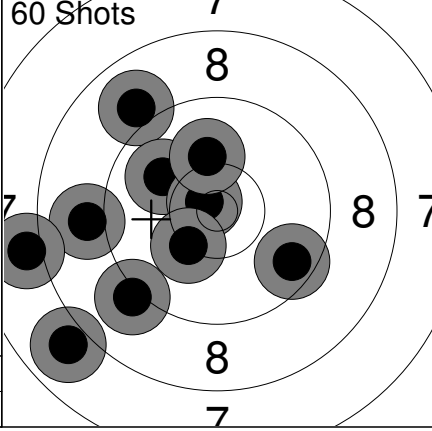

51:	9.6	↘
52:	9.0	↗
53:	10.0	↗
54:	9.0	←
55:	10.7x	↖
56:	7.9	↙
57:	9.1	↙
58:	10.3	↙
59:	10.1	↑
60:	8.0	←
Series	91 (1x)	
	536 (5x)	

<b>Relay</b> 1	<b>Lane</b> 27	<b>GUIMONT Alain</b>
-------------------	-------------------	----------------------

2023 SFC Pistol Nationals	QC	MA	MP
---------------------------	----	----	----

15.07.2023	PN23AP-Q-1	Alberta Handgun Association
------------	------------	-----------------------------

Comment	Signature
---------	-----------

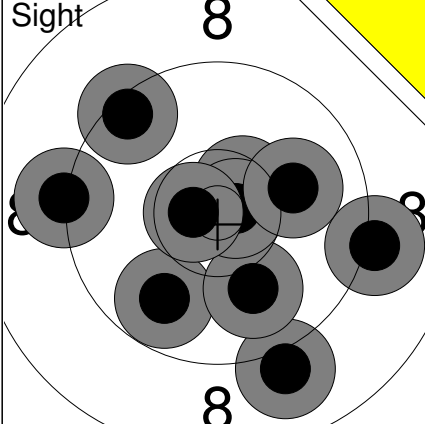
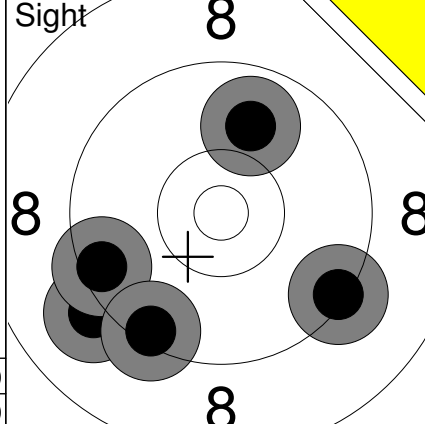
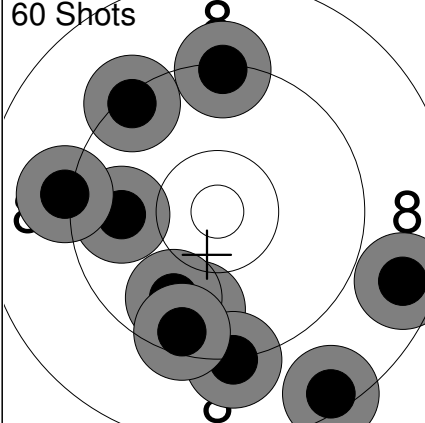
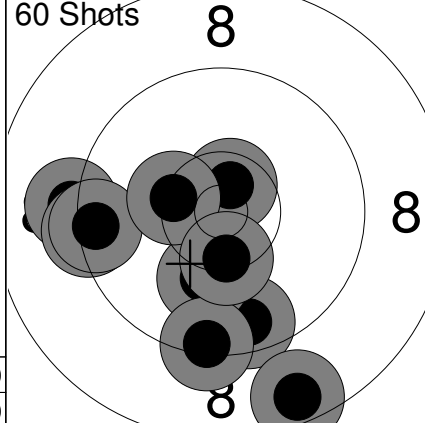
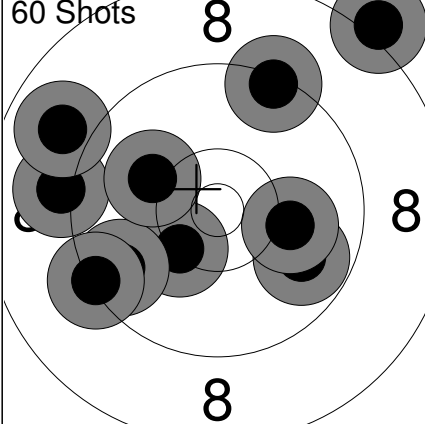
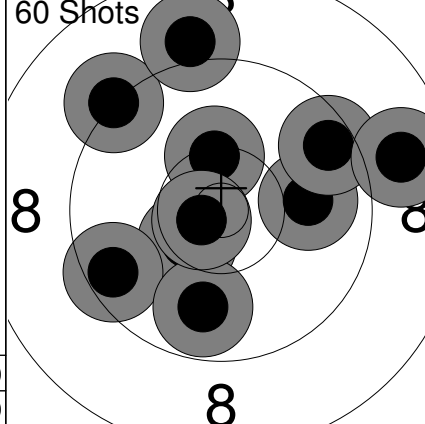
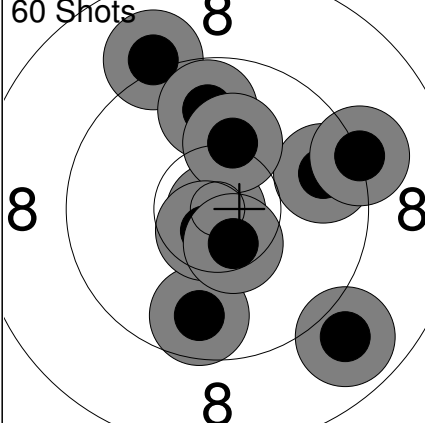
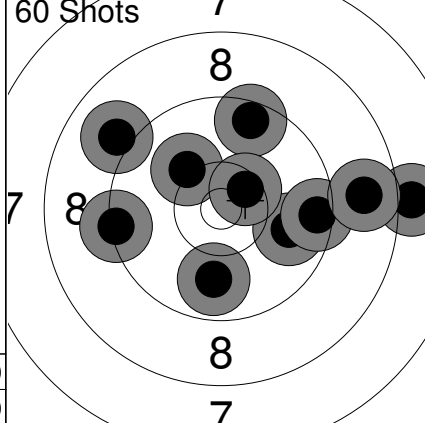
<p>Sight</p> 	<p>1: 9.1 → 2: 9.0 ↓ 3: 10.5x → 4: 9.8 ← 5: 9.2 ← 6: 10.0 ↓ 7: 10.7x → 8: 9.4 ↗ 9: 10.7x ← 10: 10.0 →</p> <p>Series 95 (3x) 0 (0x)</p>	<p>Sight</p> 	<p>11: 9.1 ↙ 12: 9.9 ↑ 13: 9.5 ← 14: 9.3 → 15: 9.4 ↘</p> <p>Series 45 (0x) 0 (0x)</p>
<p>60 Shots</p> 	<p>1: 9.8 ← 2: 9.3 ↑ 3: 9.8 ↓ 4: 9.8 ↓ 5: 9.2 ↓ 6: 9.3 ↗ 7: 8.4 ↓ 8: 8.6 → 9: 9.5 ↓ 10: 9.2 ←</p> <p>Series 88 (0x) 88 (0x)</p>	<p>60 Shots</p> 	<p>11: 10.6x ↑ 12: 9.2 ← 13: 9.6 ↓ 14: 8.5 ↓ 15: 10.1 ↓ 16: 9.3 ← 17: 9.4 ← 18: 9.4 ↓ 19: 10.4 ← 20: 10.4x ↓</p> <p>Series 93 (2x) 181 (2x)</p>
<p>60 Shots</p> 	<p>21: 10.3 ↙ 22: 9.8 ↓ 23: 9.1 ↑ 24: 8.9 ↗ 25: 10.1 → 26: 9.6 ← 27: 10.1 ↗ 28: 9.3 ↑ 29: 9.3 ← 30: 8.1 ↗</p> <p>Series 91 (0x) 272 (2x)</p>	<p>60 Shots</p> 	<p>31: 10.0 → 32: 10.4x ↙ 33: 10.3 ↑ 34: 9.5 ↗ 35: 9.2 ↗ 36: 9.0 ↑ 37: 9.5 ← 38: 9.8 ↓ 39: 8.8 → 40: 10.7x ↙</p> <p>Series 93 (2x) 365 (4x)</p>
<p>60 Shots</p> 	<p>41: 9.7 ↓ 42: 9.1 ↑ 43: 9.8 ↑ 44: 8.9 ↓ 45: 10.9x ↓ 46: 9.7 → 47: 9.2 → 48: 10.2 ↑ 49: 10.7x ↓ 50: 10.5x ↓</p> <p>Series 93 (3x) 458 (7x)</p>	<p>60 Shots</p> 	<p>51: 10.1 ↖ 52: 9.3 ← 53: 9.5 ↑ 54: 9.0 ↖ 55: 9.9 → 56: 8.0 → 57: 9.5 → 58: 10.5x ↗ 59: 9.9 ↓ 60: 8.8 →</p> <p>Series 90 (1x) 548 (8x)</p>

Relay **1** Lane **28** **AASA Toomas**

2023 SFC Pistol Nationals ON MA MP

15.07.2023 PN23AP-Q-1 Alberta Handgun Association

Comment Signature

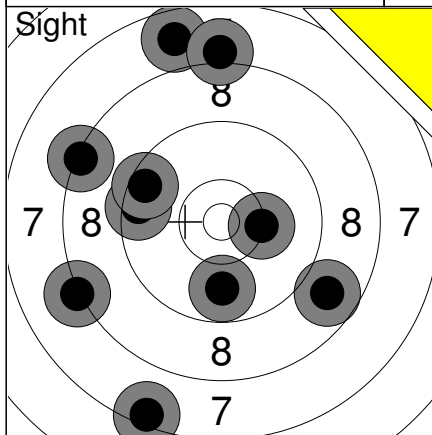

1:	10.3	→
2:	8.8	↘
3:	7.7	↗
4:	9.8	↘
5:	9.5	←
6:	8.2	↙
7:	7.4	↘
8:	8.0	↑
9:	8.3	↗
10:	9.5	↖
Series	83 (0x)	
	0 (0x)	

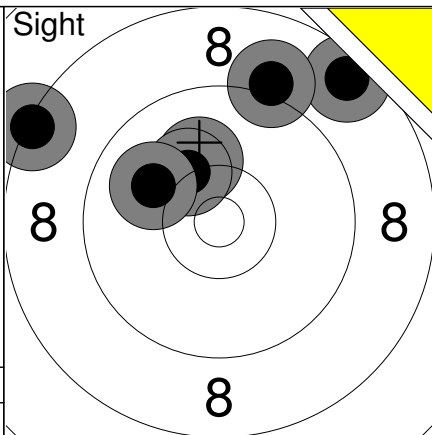

11:	8.3	↖
12:	10.1	↑
13:	8.5	↗
14:	10.2	↗
15:	9.1	↑
16:	10.0	↖
Series	55 (0x)	
	0 (0x)	

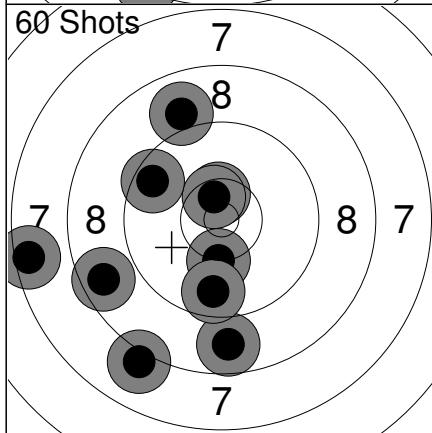

1:	10.5x	↑
2:	7.5	←
3:	10.5x	↗
4:	9.6	↖
5:	10.2	↘
6:	8.9	↗
7:	8.7	↘
8:	8.6	←
9:	9.7	↘
10:	8.1	↘
Series	87 (2x)	
	87 (2x)	

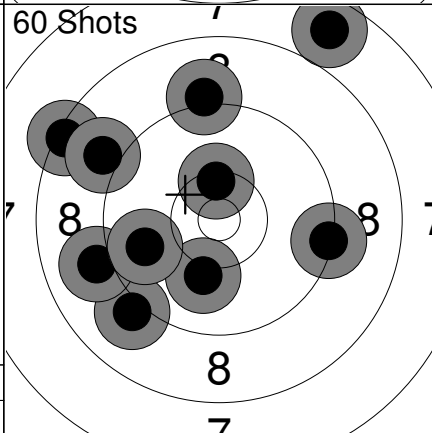

11:	8.4	↖
12:	9.1	↙
13:	9.0	↖
14:	10.1	↘
15:	9.3	→
16:	9.0	←
17:	9.8	←
18:	7.7	↗
19:	10.4x	↑
20:	9.1	↑
Series	89 (1x)	
	176 (3x)	

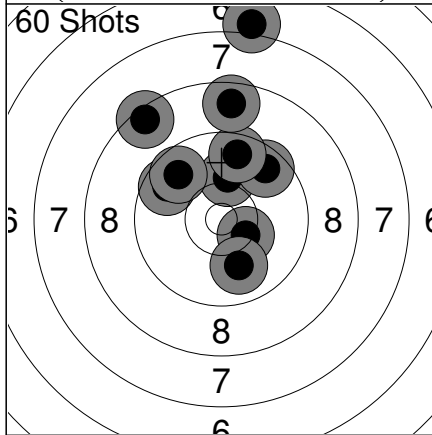

21:	10.1	↑
22:	9.7	↖
23:	7.0	↑
24:	9.7	↗
25:	9.6	↗
26:	8.5	↗
27:	10.4x	↘
28:	9.6	↑
29:	8.6	↑
30:	10.0	↘
Series	89 (1x)	
	265 (4x)	

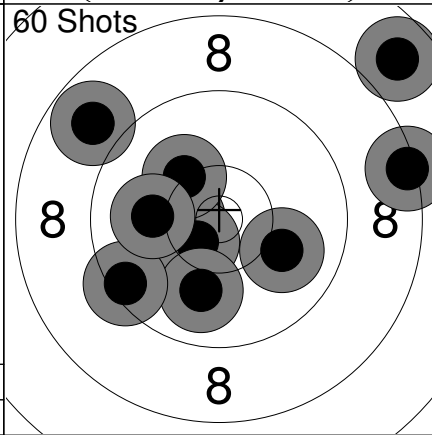

31:	7.7	↗
32:	10.5x	←
33:	10.0	→
34:	10.5x	↙
35:	10.2	↗
36:	10.0	↘
37:	8.8	↗
38:	8.3	→
39:	9.4	↙
40:	10.1	←
Series	92 (2x)	
	357 (6x)	

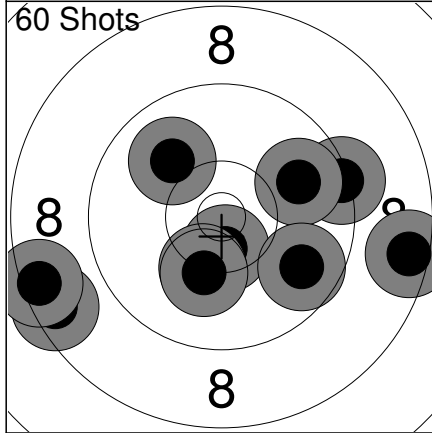

41:	10.5x	↘
42:	10.3	↘
43:	9.3	→
44:	10.2	↘
45:	9.9	→
46:	8.5	↙
47:	8.5	↙
48:	10.0	↗
49:	8.5	→
50:	9.7	↘
Series	91 (1x)	
	448 (7x)	

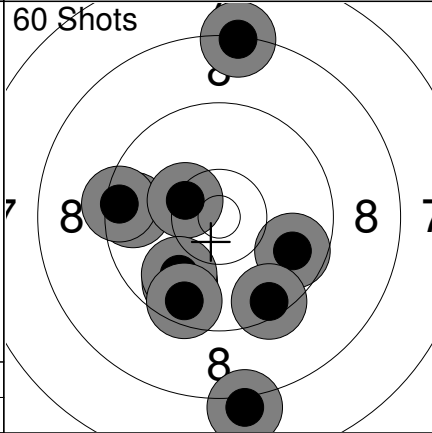

51:	9.7	←
52:	9.4	←
53:	8.1	↘
54:	10.4x	↖
55:	9.8	↘
56:	9.7	→
57:	9.9	↙
58:	9.5	↘
59:	9.6	↘
60:	8.3	↑
Series	89 (1x)	
	537 (8x)	

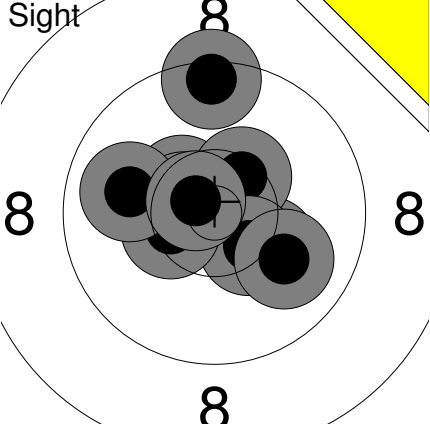
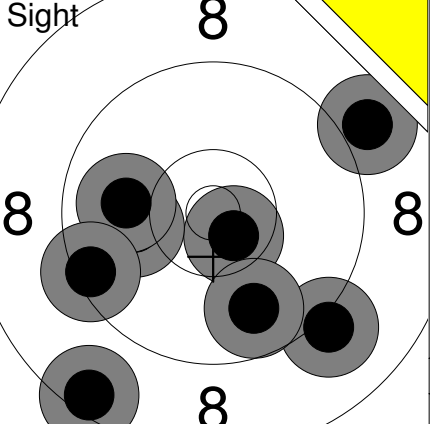
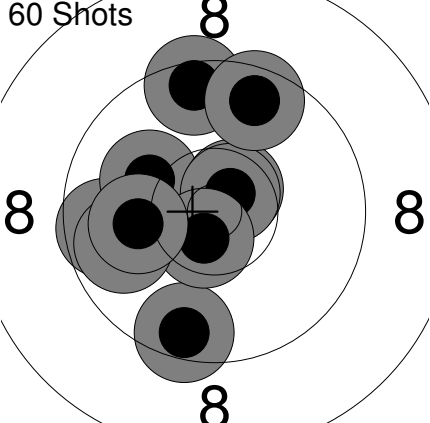
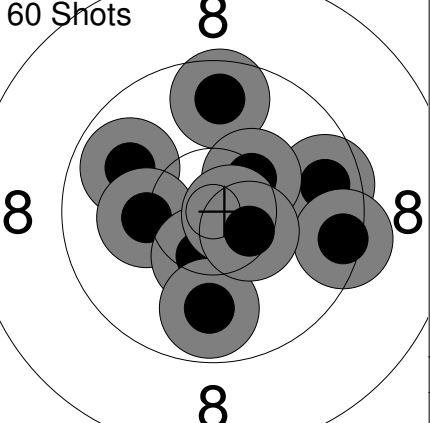
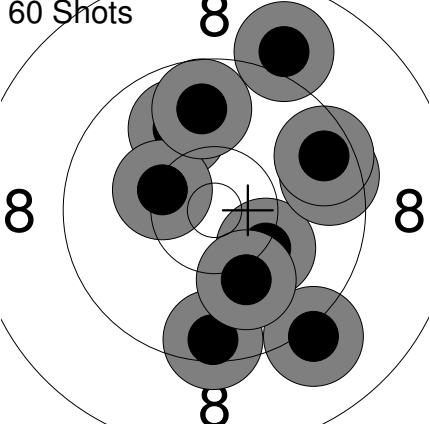
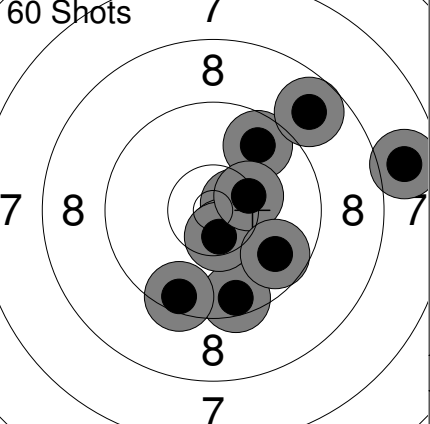
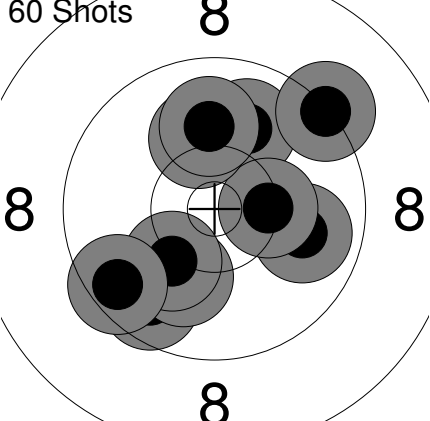
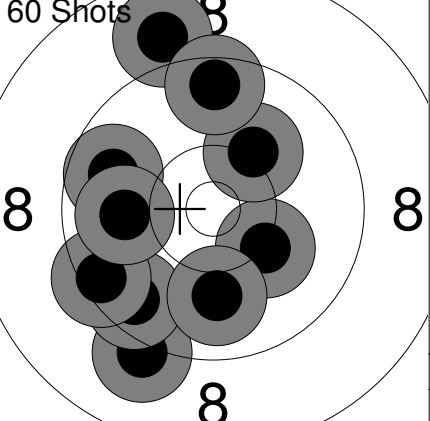

<p>Sight</p> 	<p>1: 9.4    ↑</p> <p>2: 10.2    ↓</p> <p>3: 10.5x    ↗</p> <p>4: 10.6x    ↖</p> <p>5: 10.4x    ↗</p> <p>6: 10.4x    ↓</p> <p>7: 10.4x    ↖</p> <p>8: 10.0    ↖</p> <p>9: 10.0    ↓</p> <p>10: 10.7x    ↗</p> <hr/> <p>Series            99 ( 6x)</p> <p>                    0 ( 0x)</p>	<p>Sight</p> 	<p>11: 10.6x    ↓</p> <p>12: 9.1        ↓</p> <p>13: 10.0        ←</p> <p>14: 8.9         ↗</p> <p>15: 10.0        ←</p> <p>16: 9.4         ↖</p> <p>17: 8.4         ↓</p> <p>18: 9.8         ↓</p> <hr/> <p>Series            73 ( 1x)</p> <p>                    0 ( 0x)</p>
<p>60 Shots</p> 	<p>1: 9.7        ←</p> <p>2: 10.1        ↗</p> <p>3: 10.6x        ↗</p> <p>4: 9.5         ↓</p> <p>5: 9.5         ↑</p> <p>6: 10.7x        ↗</p> <p>7: 10.6x        ↓</p> <p>8: 9.9         ↖</p> <p>9: 10.1        ←</p> <p>10: 9.6         ↑</p> <hr/> <p>Series            95 ( 3x)</p> <p>                    95 ( 3x)</p>	<p>60 Shots</p> 	<p>11: 9.9        ↖</p> <p>12: 9.6        →</p> <p>13: 10.2        ←</p> <p>14: 10.4x       ↓</p> <p>15: 9.7        ↑</p> <p>16: 10.4x       ↗</p> <p>17: 9.4        →</p> <p>18: 10.7x       →</p> <p>19: 9.8        ↓</p> <p>20: 10.5x       ↘</p> <hr/> <p>Series            95 ( 4x)</p> <p>                    190 ( 7x)</p>
<p>60 Shots</p> 	<p>21: 10.2        ↘</p> <p>22: 9.5         ↓</p> <p>23: 9.9         ↗</p> <p>24: 10.3        ↖</p> <p>25: 9.1         ↓</p> <p>26: 10.1        ↓</p> <p>27: 9.8         ↗</p> <p>28: 9.6         →</p> <p>29: 9.0         ↑</p> <p>30: 9.6         ↗</p> <hr/> <p>Series            93 ( 0x)</p> <p>                    283 ( 7x)</p>	<p>60 Shots</p> 	<p>31: 9.5        ↓</p> <p>32: 7.8        →</p> <p>33: 10.6x       →</p> <p>34: 10.5x       ↓</p> <p>35: 10.5x       ↓</p> <p>36: 9.7        ↗</p> <p>37: 10.3        →</p> <p>38: 9.7        ↘</p> <p>39: 8.8        ↗</p> <p>40: 9.5        ↓</p> <hr/> <p>Series            91 ( 3x)</p> <p>                    374 ( 10x)</p>
<p>60 Shots</p> 	<p>41: 9.9        →</p> <p>42: 9.7        ↓</p> <p>43: 10.0        ↗</p> <p>44: 10.1        ↓</p> <p>45: 10.2        ↓</p> <p>46: 10.3        →</p> <p>47: 10.1        ↑</p> <p>48: 9.6        ↖</p> <p>49: 10.0        ↑</p> <p>50: 9.3        ↗</p> <hr/> <p>Series            96 ( 0x)</p> <p>                    470 ( 10x)</p>	<p>60 Shots</p> 	<p>51: 9.8        ↖</p> <p>52: 10.2        ↘</p> <p>53: 9.1        ↓</p> <p>54: 9.6        ↖</p> <p>55: 10.2        ↗</p> <p>56: 9.5        ↖</p> <p>57: 8.9        ↑</p> <p>58: 9.5        ↑</p> <p>59: 10.0        ↓</p> <p>60: 9.9        ←</p> <hr/> <p>Series            92 ( 0x)</p> <p>                    562 ( 10x)</p>

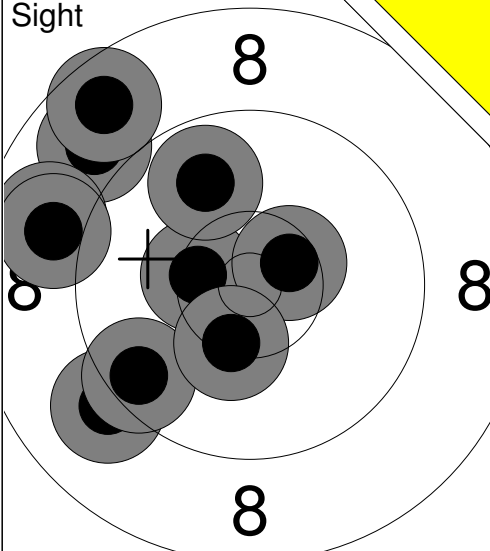
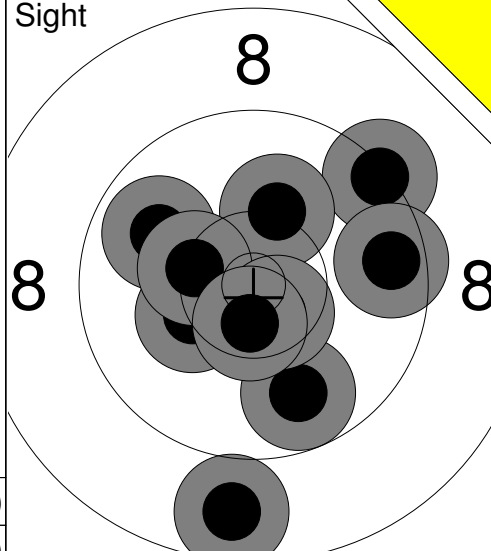

<p>Sight</p> 	<p>1: 8.9 ↗ 2: 9.1 ↙ 3: 10.4x ← 4: 10.5x → 5: 8.7 ↗ 6: 8.9 ← 7: 9.5 ↙ 8: 10.3 ↓ 9: 9.9 ↗ 10: 8.9 ←</p> <p>Series 89 ( 2x) 0 ( 0x)</p>	<p>Sight</p> 	<p>11: 9.9 ↖ 12: 10.3 ← 13: 9.3 ↗ 14: 10.2 ↑ 15: 9.8 ↓ 16: 10.3 ← 17: 8.7 ↓ 18: 10.6x ↓ 19: 9.6 → 20: 10.6x ↓</p> <p>Series 94 ( 2x) 0 ( 0x)</p>
---	---	---	--

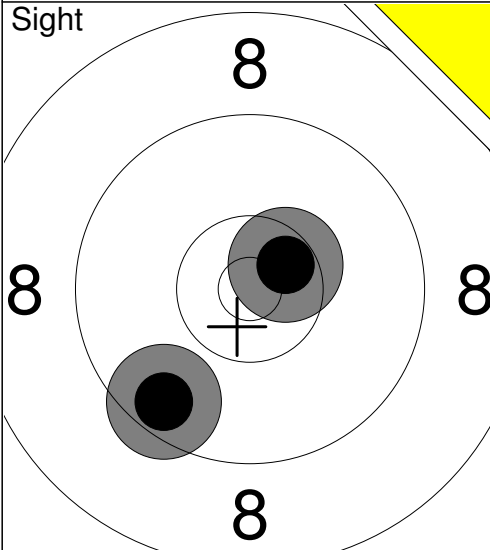
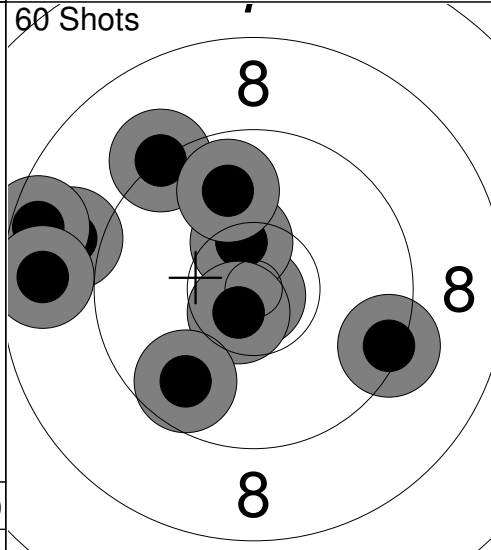
<p>Sight</p> 	<p>21: 10.5x → 22: 9.6 ↙</p> <p>Series 19 ( 1x) 0 ( 0x)</p>	<p>60 Shots</p> 	<p>1: 10.9x ↓ 2: 10.4x ↑ 3: 9.2 ↗ 4: 9.9 ↑ 5: 8.9 ← 6: 8.5 ← 7: 9.4 → 8: 8.7 ← 9: 10.7x ↓ 10: 9.7 ↓</p> <p>Series 90 ( 3x) 90 ( 3x)</p>
--	---	---	---

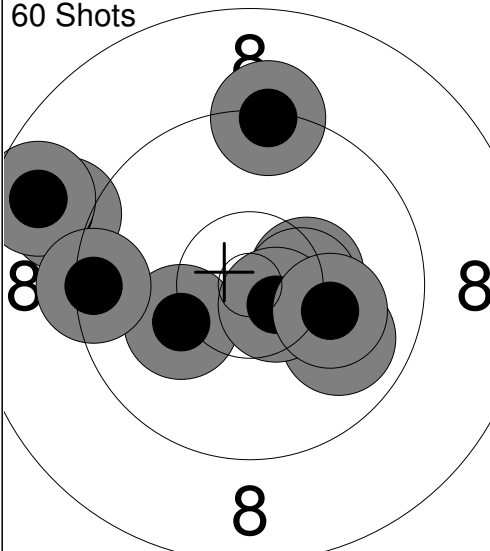
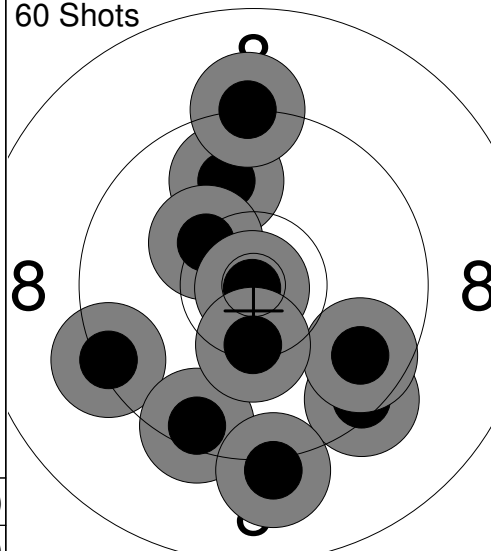
<p>60 Shots</p> 	<p>11: 10.4x → 12: 9.9 ↘ 13: 9.0 ← 14: 8.7 ← 15: 10.4x → 16: 9.3 ↑ 17: 10.2 ← 18: 10.6x ↘ 19: 9.4 ← 20: 10.1 →</p> <p>Series 94 ( 3x) 184 ( 6x)</p>	<p>60 Shots</p> 	<p>21: 9.9 ↑ 22: 9.4 ↘ 23: 9.3 ← 24: 9.2 ↑ 25: 9.7 ↘ 26: 10.3 ↗ 27: 10.9x ↓ 28: 9.5 ↓ 29: 9.1 ↓ 30: 10.4x ↓</p> <p>Series 93 ( 2x) 277 ( 8x)</p>
--	---	--	--

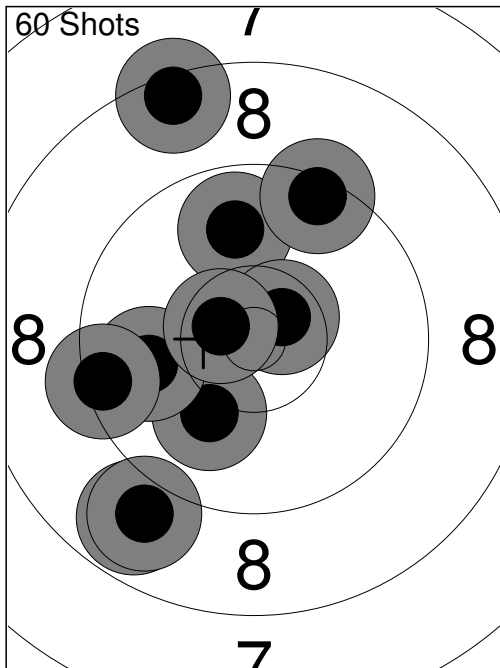

31:	8.8	↙
32:	8.9	↙
33:	8.4	↗
34:	10.1	↙
35:	9.9	↗
36:	10.6x	↗
37:	9.4	↗
38:	9.9	←
39:	10.6x	↙
40:	9.4	←
Series	90 ( 2x)	
367 (10x)		

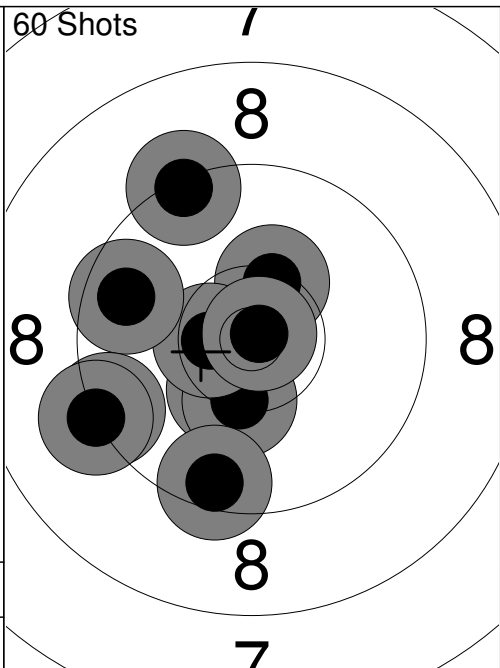

41:	10.4x	↗
42:	10.4x	↙
43:	10.3	↙
44:	10.5x	←
45:	9.6	←
46:	9.4	↙
47:	9.3	↗
48:	10.9x	↗
49:	9.5	↙
50:	9.2	↙
Series	95 ( 4x)	
462 (14x)		

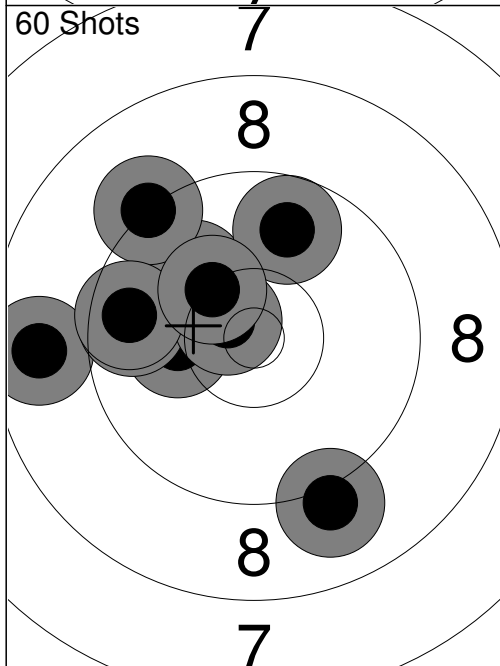

51:	8.7	←
52:	10.0	↗
53:	9.1	↙
54:	10.2	←
55:	9.7	←
56:	9.2	↗
57:	10.6x	↙
58:	9.6	←
59:	9.8	↗
60:	10.3	↙
Series	93 ( 1x)	
555 (15x)		

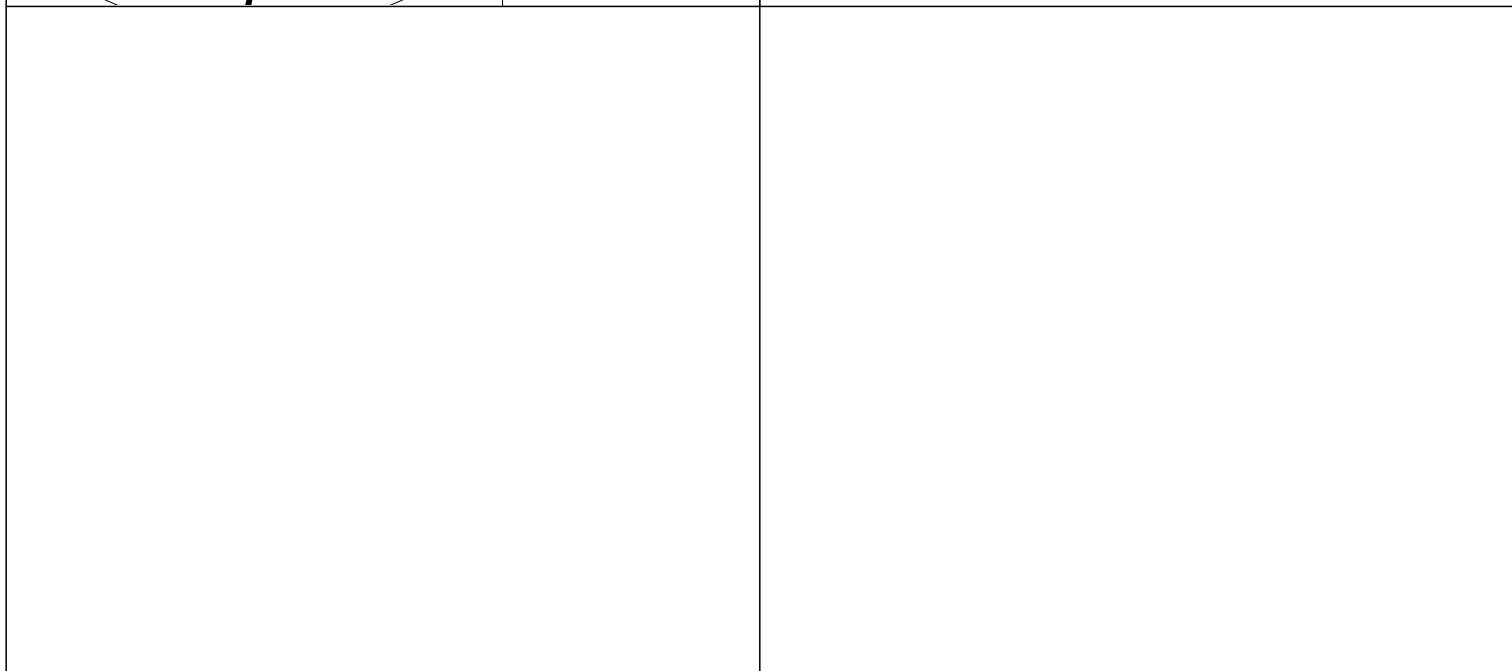

Relay **2** Lane **1** **HUANG Margaret**

2023 SFC Pistol Nationals BC SJ WP

15.07.2023 PN23AP-Q-1 Alberta Handgun Association

Comment Signature

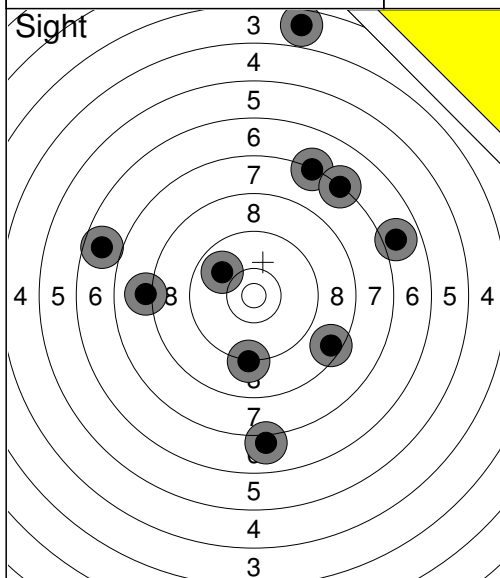

1:	3.6	↑
2:	7.0	↓
3:	7.2	↑
4:	6.9	→
5:	8.5	↘
6:	6.7	←
7:	7.3	↗
8:	9.9	↖
9:	8.1	←
10:	9.2	↓
Series	70 (0x)	
	0 (0x)	

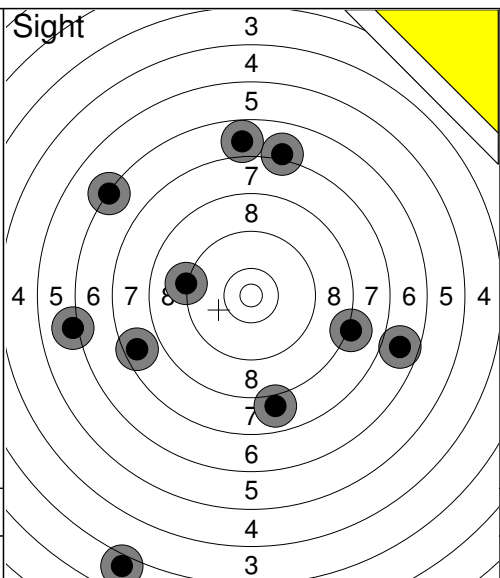

11:	6.1	←
12:	7.6	↙
13:	7.1	↑
14:	8.1	→
15:	6.8	↑
16:	7.9	↓
17:	6.7	→
18:	2.9	↓
19:	9.2	←
20:	6.3	↖
Series	64 (0x)	
	0 (0x)	

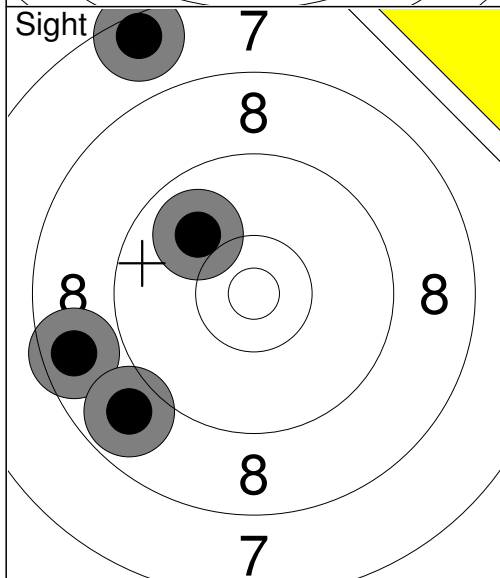

21:	8.6	←
22:	8.8	↙
23:	10.0	↗
24:	7.5	↑
Series	33 (0x)	
	0 (0x)	

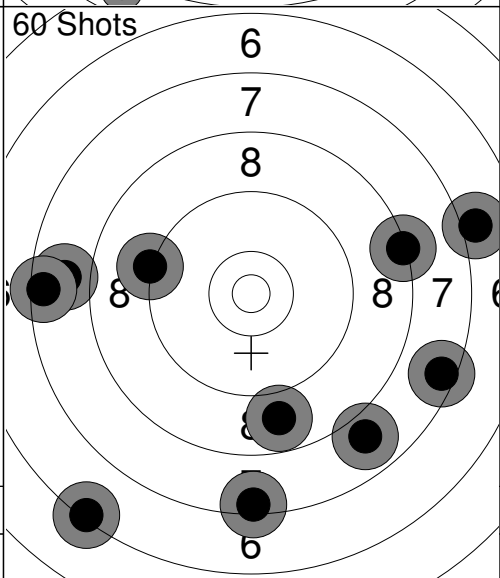

1:	7.8	←
2:	7.0	→
3:	7.4	↓
4:	7.4	←
5:	8.3	→
6:	8.8	↓
7:	6.3	↙
8:	9.2	←
9:	7.9	↓
10:	7.5	→
Series	73 (0x)	
	73 (0x)	

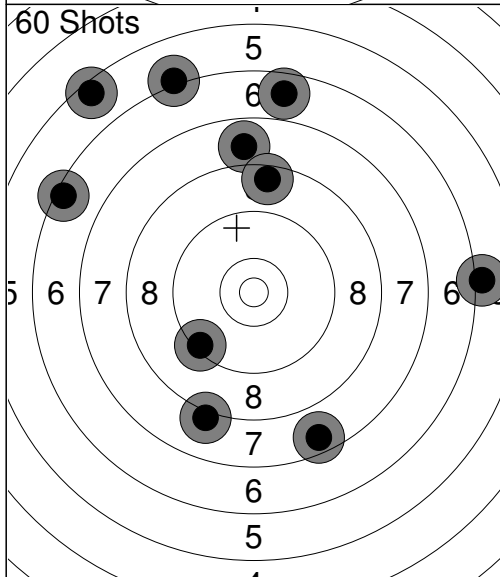

11:	7.8	↑
12:	9.3	↙
13:	7.6	↓
14:	6.4	↖
15:	8.1	↓
16:	6.1	→
17:	6.1	↑
18:	6.7	↑
19:	8.5	↑
20:	5.5	↖
Series	68 (0x)	
	141 (0x)	

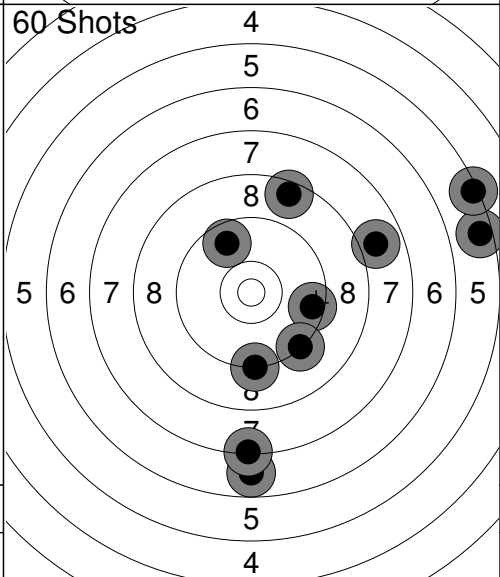

21:	9.2	↓
22:	5.5	→
23:	5.3	↗
24:	9.7	↑
25:	8.5	↑
26:	9.5	→
27:	6.8	↓
28:	7.3	↓
29:	9.3	↘
30:	7.9	↗
Series	74 (0x)	
	215 (0x)	

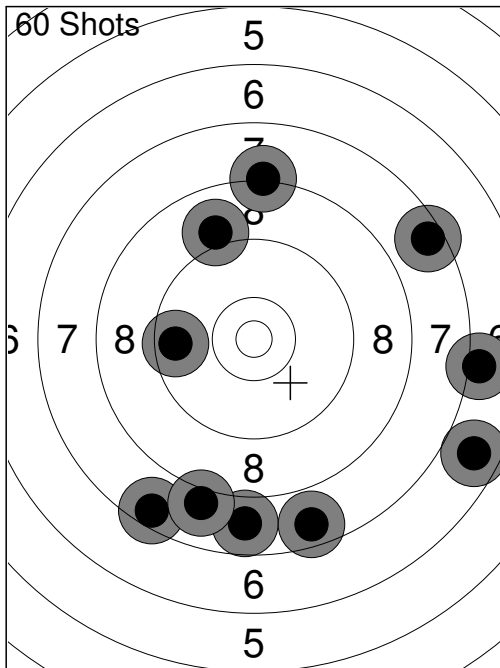

31:	6.7	↘
32:	9.6	←
33:	7.8	↓
34:	7.5	↘
35:	8.0	↓
36:	7.6	↓
37:	7.0	→
38:	7.5	↗
39:	9.0	↑
40:	8.2	↑
Series	75 ( 0x)	
	290 ( 0x)	

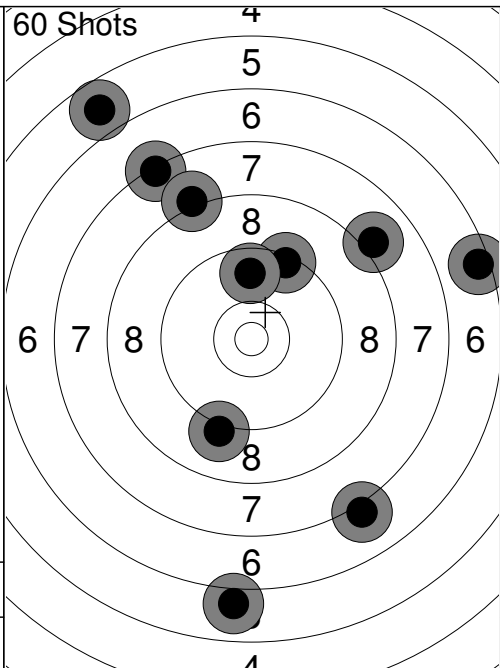

41:	5.8	↖
42:	7.3	↖
43:	8.1	↖
44:	9.4	↗
45:	8.0	↗
46:	6.4	→
47:	5.9	↓
48:	7.1	↘
49:	9.1	↓
50:	9.7	↑
Series	73 ( 0x)	
	363 ( 0x)	

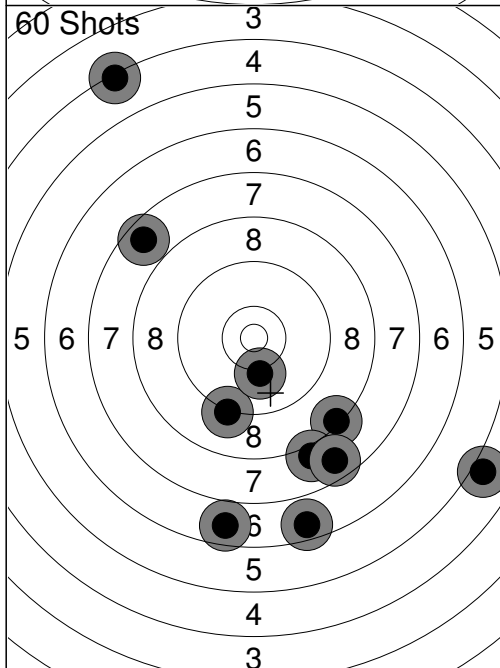

51:	4.3	↖
52:	9.2	↓
53:	6.6	↓
54:	8.3	↘
55:	7.6	↗
56:	5.0	↘
57:	10.1	↓
58:	8.0	↓
59:	6.7	↓
60:	7.6	↘
Series	70 ( 0x)	
	433 ( 0x)	

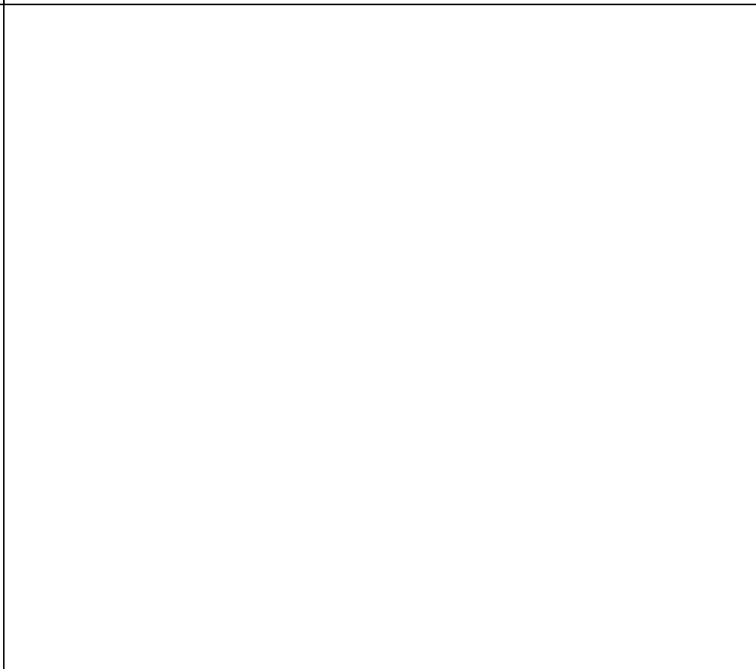
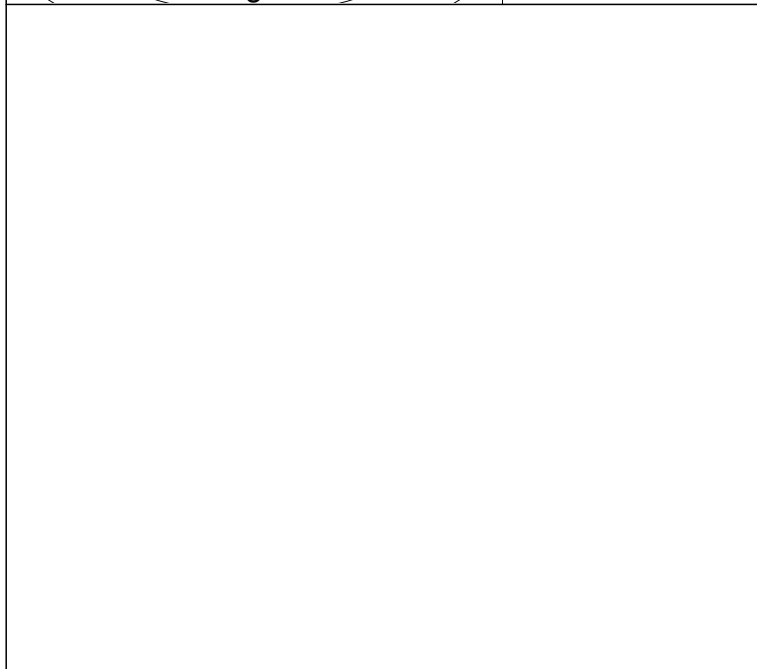

Relay <b>2</b>	Lane <b>2</b>	<b>XU Kitty</b>
-------------------	------------------	-----------------

2023 SFC Pistol Nationals BC	SJ	WP
------------------------------	----	----

15.07.2023	PN23AP-Q-1	Alberta Handgun Association
------------	------------	-----------------------------

Comment	Signature
---------	-----------

<p>Sight</p>	<p>Sight</p>	<table style="width:100%; border-collapse: collapse;"> <tr><td>1:</td><td>10.3</td><td>↖</td></tr> <tr><td>2:</td><td>9.0</td><td>↗</td></tr> <tr><td>3:</td><td>5.1</td><td>↑</td></tr> <tr><td>4:</td><td>1.9</td><td>↗</td></tr> <tr><td>5:</td><td>5.4</td><td>↑</td></tr> <tr><td>6:</td><td>5.8</td><td>←</td></tr> <tr><td>7:</td><td>7.3</td><td>↓</td></tr> <tr><td>8:</td><td>7.9</td><td>←</td></tr> <tr><td>9:</td><td>4.5</td><td>↘</td></tr> <tr><td>10:</td><td>7.9</td><td>↖</td></tr> <tr><td colspan="2"><b>Series 60 (0x)</b></td></tr> <tr><td colspan="2">0 (0x)</td></tr> </table>	1:	10.3	↖	2:	9.0	↗	3:	5.1	↑	4:	1.9	↗	5:	5.4	↑	6:	5.8	←	7:	7.3	↓	8:	7.9	←	9:	4.5	↘	10:	7.9	↖	<b>Series 60 (0x)</b>		0 (0x)	
1:	10.3	↖																																		
2:	9.0	↗																																		
3:	5.1	↑																																		
4:	1.9	↗																																		
5:	5.4	↑																																		
6:	5.8	←																																		
7:	7.3	↓																																		
8:	7.9	←																																		
9:	4.5	↘																																		
10:	7.9	↖																																		
<b>Series 60 (0x)</b>																																				
0 (0x)																																				

<p>Sight</p>	<p>60 Shots</p>	<table style="width:100%; border-collapse: collapse;"> <tr><td>21:</td><td>2.2</td><td>↗</td></tr> <tr><td>22:</td><td>9.3</td><td>↓</td></tr> <tr><td>23:</td><td>6.3</td><td>←</td></tr> <tr><td colspan="2"><b>Series 17 (0x)</b></td></tr> <tr><td colspan="2">0 (0x)</td></tr> </table>	21:	2.2	↗	22:	9.3	↓	23:	6.3	←	<b>Series 17 (0x)</b>		0 (0x)	
21:	2.2	↗													
22:	9.3	↓													
23:	6.3	←													
<b>Series 17 (0x)</b>															
0 (0x)															

<p>60 Shots</p>	<p>60 Shots</p>	<table style="width:100%; border-collapse: collapse;"> <tr><td>11:</td><td>6.1</td><td>↓</td></tr> <tr><td>12:</td><td>6.0</td><td>→</td></tr> <tr><td>13:</td><td>4.4</td><td>↓</td></tr> <tr><td>14:</td><td>6.1</td><td>↓</td></tr> <tr><td>15:</td><td>6.1</td><td>↘</td></tr> <tr><td>16:</td><td>8.3</td><td>←</td></tr> <tr><td>17:</td><td>6.6</td><td>←</td></tr> <tr><td>18:</td><td>6.2</td><td>↘</td></tr> <tr><td>19:</td><td>8.0</td><td>←</td></tr> <tr><td>20:</td><td>2.5</td><td>↑</td></tr> <tr><td colspan="2"><b>Series 58 (0x)</b></td></tr> <tr><td colspan="2">130 (0x)</td></tr> </table>	11:	6.1	↓	12:	6.0	→	13:	4.4	↓	14:	6.1	↓	15:	6.1	↘	16:	8.3	←	17:	6.6	←	18:	6.2	↘	19:	8.0	←	20:	2.5	↑	<b>Series 58 (0x)</b>		130 (0x)	
11:	6.1	↓																																		
12:	6.0	→																																		
13:	4.4	↓																																		
14:	6.1	↓																																		
15:	6.1	↘																																		
16:	8.3	←																																		
17:	6.6	←																																		
18:	6.2	↘																																		
19:	8.0	←																																		
20:	2.5	↑																																		
<b>Series 58 (0x)</b>																																				
130 (0x)																																				

60 Shots

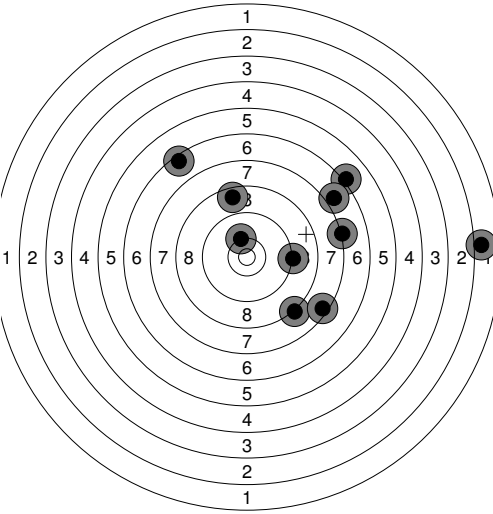

- 31: 8.2 ↘
- 32: 9.2 →
- 33: 8.6 ↑
- 34: 2.0 →
- 35: 6.1 ↗
- 36: 7.4 ↘
- 37: 7.2 →
- 38: 10.2 ↑
- 39: 6.9 ↗
- 40: 6.5 ↖

Series 69 ( 0x)  
254 ( 0x)

60 Shots

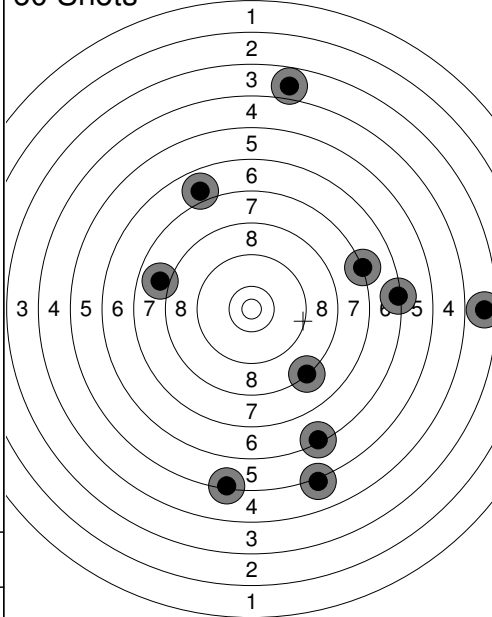

- 41: 6.3 ↘
- 42: 3.8 ↑
- 43: 5.1 ↘
- 44: 6.9 ↗
- 45: 8.3 ↘
- 46: 5.3 ↓
- 47: 7.9 ←
- 48: 7.2 →
- 49: 3.6 →
- 50: 6.3 →

Series 56 ( 0x)  
310 ( 0x)

60 Shots

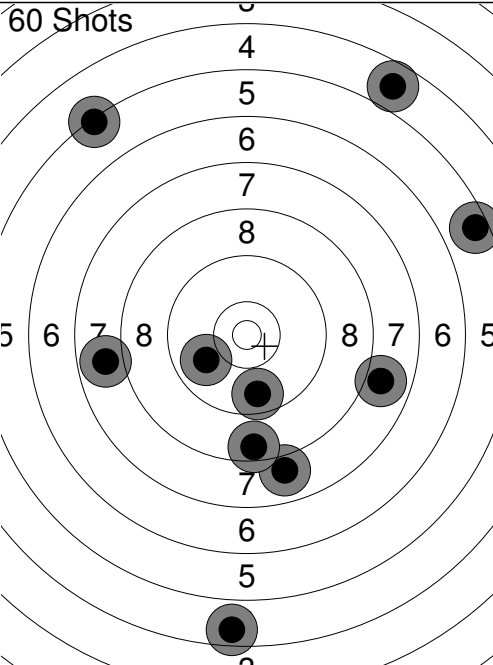

- 51: 5.5 ↗
- 52: 4.7 ↗
- 53: 7.9 ←
- 54: 7.9 ↓
- 55: 9.7 ↓
- 56: 5.3 ↗
- 57: 8.5 ↓
- 58: 4.6 ↓
- 59: 9.9 ↖
- 60: 7.9 →

Series 65 ( 0x)  
375 ( 0x)



Relay **2** Lane **3** **ZHENG Tingxi**

2023 SFC Pistol Nationals BC SJ WP

15.07.2023 PN23AP-Q-1 Alberta Handgun Association

Comment Signature

<p>Sight</p>	<p>1: 7.6 ↓            2: 6.8 ↖            3: 8.4 ↗            4: 8.8 ←            5: 10.7x ←            6: 8.6 ↗            7: 8.6 ←            8: 10.0 ↓            9: 9.3 →            10: 8.6 →</p> <p>Series 82 (1x) 0 (0x)</p>	<p>Sight</p>	<p>11: 6.4 →            12: 5.9 →            13: 7.4 ↓            14: 9.2 →            15: 6.7 ↘            16: 9.0 ↓</p> <p>Series 42 (0x) 0 (0x)</p>
<p>60 Shots</p>	<p>1: 8.0 ↓            2: 9.8 ↗            3: 8.9 ↖            4: 8.6 →            5: 8.1 ↓            6: 8.0 ↓            7: 9.5 ↗            8: 7.2 ←            9: 9.4 →            10: 9.6 ↑</p> <p>Series 83 (0x) 83 (0x)</p>	<p>60 Shots</p>	<p>11: 10.1 ↘            12: 8.3 →            13: 8.2 ↗            14: 6.9 ↑            15: 8.3 ↗            16: 8.1 ↓            17: 6.1 →            18: 9.5 →            19: 5.8 ↑            20: 8.6 ↗</p> <p>Series 76 (0x) 159 (0x)</p>
<p>60 Shots</p>	<p>21: 8.2 ←            22: 8.4 ↓            23: 9.4 ↗            24: 10.0 ←            25: 8.4 ↓            26: 8.6 ↘            27: 9.1 ←            28: 9.9 ↑            29: 6.5 →            30: 9.4 ↗</p> <p>Series 84 (0x) 243 (0x)</p>	<p>60 Shots</p>	<p>31: 6.9 ↑            32: 9.2 →            33: 8.4 ↗            34: 9.2 ↗            35: 8.6 ↑            36: 8.7 ←            37: 8.3 ←            38: 8.1 ↗            39: 6.6 ↗            40: 7.5 →</p> <p>Series 77 (0x) 320 (0x)</p>
<p>60 Shots</p>	<p>41: 10.1 →            42: 8.0 →            43: 8.2 ↗            44: 7.7 ↘            45: 6.7 ↓            46: 6.9 ↖            47: 8.0 ↑            48: 7.7 ↑            49: 9.7 ↗            50: 9.4 →</p> <p>Series 78 (0x) 398 (0x)</p>	<p>60 Shots</p>	<p>51: 9.3 ↖            52: 9.9 →            53: 4.8 ←            54: 9.0 ←            55: 7.0 ↓            56: 9.9 →            57: 7.3 ↖            58: 9.3 ↗            59: 6.8 ↓            60: 6.9 ↑</p> <p>Series 75 (0x) 473 (0x)</p>

Relay <b>2</b>	Lane <b>4</b>	<b>YIN Jinxi</b>
-------------------	------------------	------------------

2023 SFC Pistol Nationals	BC	SJ	WP
---------------------------	----	----	----

15.07.2023	PN23AP-Q-1	Alberta Handgun Association
------------	------------	-----------------------------

Comment	Signature
---------	-----------

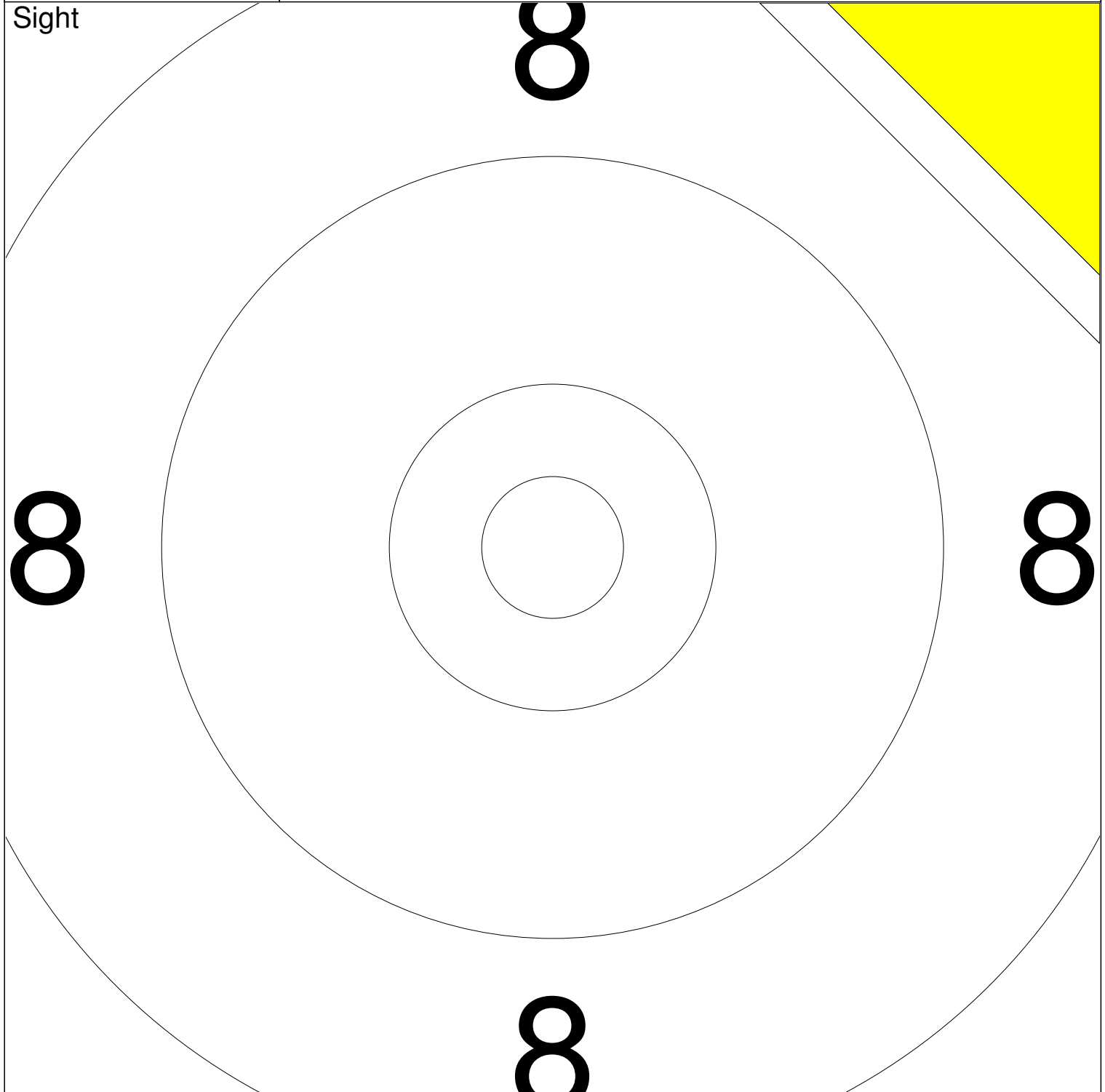

	Series	0 ( 0x)
		0 ( 0x)



Relay **2** Lane **6** **NICOL Sophia ting**

2023 SFC Pistol Nationals BC SJ WP

15.07.2023 PN23AP-Q-1 Alberta Handgun Association

Comment Signature

<p>Sight</p>	<p>1: 8.8 ↑ 2: 7.5 ↗ 3: 6.6 ← 4: 9.2 ↓ 5: 8.6 ← 6: 8.4 ↗ 7: 9.5 ↓ 8: 9.2 ↑ 9: 10.1 ↗ 10: 10.3 ↓</p> <p>Series 84 (0x) 0 (0x)</p>	<p>Sight</p>	<p>11: 9.5 → 12: 9.3 ↓ 13: 6.8 → 14: 7.5 ↗ 15: 9.7 ↓ 16: 9.5 ←</p> <p>Series 49 (0x) 0 (0x)</p>
<p>60 Shots</p>	<p>1: 6.9 ↓ 2: 9.5 ↗ 3: 9.1 ↑ 4: 5.5 ↗ 5: 9.4 ← 6: 9.2 ↗ 7: 8.2 ↓ 8: 10.6x ↓ 9: 7.8 ↓ 10: 9.0 ↓</p> <p>Series 81 (1x) 81 (1x)</p>	<p>60 Shots</p>	<p>11: 10.2 ↑ 12: 10.4x ↓ 13: 9.5 → 14: 9.2 ↓ 15: 8.8 ↓ 16: 8.6 → 17: 8.1 ↑ 18: 9.1 ← 19: 7.9 ← 20: 9.0 ←</p> <p>Series 87 (1x) 168 (2x)</p>
<p>60 Shots</p>	<p>21: 8.3 → 22: 9.8 ← 23: 8.6 → 24: 10.1 ← 25: 8.9 ↓ 26: 8.1 ↑ 27: 8.6 ↓ 28: 9.3 → 29: 8.9 ← 30: 8.9 ↑</p> <p>Series 84 (0x) 252 (2x)</p>	<p>60 Shots</p>	<p>31: 10.5x ↑ 32: 9.9 → 33: 8.8 ↑ 34: 9.7 ← 35: 8.6 ↓ 36: 8.1 ↑ 37: 9.8 → 38: 8.1 ← 39: 8.6 ↑ 40: 8.6 ←</p> <p>Series 85 (1x) 337 (3x)</p>
<p>60 Shots</p>	<p>41: 10.7x ↗ 42: 10.4x ↓ 43: 10.3 ↗ 44: 8.6 ↓ 45: 9.4 ↓ 46: 9.5 ↓ 47: 9.1 ↗ 48: 10.1 ↓ 49: 9.5 ← 50: 8.4 ↓</p> <p>Series 92 (2x) 429 (5x)</p>	<p>60 Shots</p>	<p>51: 9.1 ↑ 52: 9.1 ↑ 53: 9.1 ↗ 54: 8.7 ↓ 55: 9.4 ← 56: 10.4x ← 57: 9.7 ↓ 58: 6.8 ↓ 59: 10.3 ↓ 60: 10.1 ↑</p> <p>Series 89 (1x) 518 (6x)</p>

Relay **2** Lane **7** **HAN Kally**

2023 SFC Pistol Nationals BC JR WP

15.07.2023 PN23AP-Q-1 Alberta Handgun Association

Comment Signature

	1: 9.0 → 2: 8.9 ↘ 3: 9.3 ↓ 4: 10.0 ↗ 5: 10.1 ↗ 6: 8.7 ↗ 7: 9.3 ↓ 8: 7.8 ↑ 9: 10.6x ↗ 10: 10.0 ↑		11: 9.2 → 12: 10.2 ↓ 13: 9.7 ↗ 14: 10.0 ↗ 15: 9.2 ↗ 16: 9.6 ↗ 17: 10.0 ↓ 18: 10.5x ↗ 19: 9.2 ↗ 20: 10.2 ↓
	Series 90 (1x) 0 (0x)		Series 95 (1x) 0 (0x)
	1: 8.9 ↘ 2: 10.0 ↖ 3: 10.3 ↓ 4: 10.1 → 5: 7.6 ↓ 6: 9.3 → 7: 10.2 ↑ 8: 8.8 ↘ 9: 9.4 ↑ 10: 8.9 ↑		11: 9.5 → 12: 9.4 ↑ 13: 9.7 ↑ 14: 9.6 ↖ 15: 9.8 ↑ 16: 9.7 ↓ 17: 9.0 → 18: 9.3 ↑ 19: 7.6 ↑ 20: 8.9 →
	Series 89 (0x) 89 (0x)		Series 87 (0x) 176 (0x)
	21: 9.4 ↖ 22: 9.4 ↗ 23: 10.0 ↑ 24: 9.6 ↑ 25: 8.6 ↗ 26: 8.0 ↖ 27: 9.7 ↑ 28: 9.5 ↖ 29: 10.6x ↖ 30: 10.0 ↗		31: 7.8 ↗ 32: 8.9 ↗ 33: 10.0 ↑ 34: 9.1 → 35: 8.2 ↖ 36: 9.1 ↓ 37: 10.0 ↖ 38: 9.3 ↑ 39: 9.8 ↖ 40: 10.2 ↖
	Series 91 (1x) 267 (1x)		Series 89 (0x) 356 (1x)
	41: 9.4 → 42: 8.5 ↖ 43: 10.2 ↖ 44: 8.6 ↖ 45: 10.2 ↗ 46: 9.9 ↗ 47: 8.8 ↘ 48: 8.8 → 49: 9.3 ↓ 50: 8.5 ↑		51: 9.2 ↗ 52: 9.8 ↑ 53: 9.7 ↖ 54: 8.5 ↖ 55: 10.3 ↖ 56: 10.7x ↘ 57: 8.7 ↑ 58: 9.7 → 59: 8.0 → 60: 7.7 ↗
	Series 87 (0x) 443 (1x)		Series 87 (1x) 530 (2x)

Relay **2** Lane **8** **LIU Nina jia rui**

2023 SFC Pistol Nationals BC JR WP

15.07.2023 PN23AP-Q-1 Alberta Handgun Association

Comment Signature

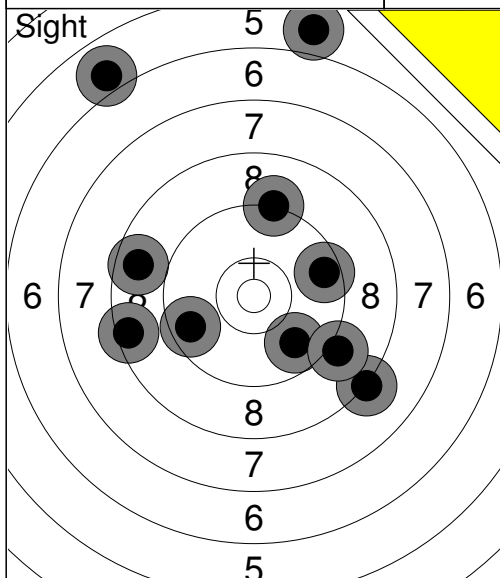

1:	8.7	←
2:	9.6	←
3:	9.2	↑
4:	5.9	↗
5:	8.5	←
6:	8.2	↘
7:	9.5	→
8:	5.8	↑
9:	9.8	↘
10:	9.0	↘
Series	79 (0x)	
	0 (0x)	

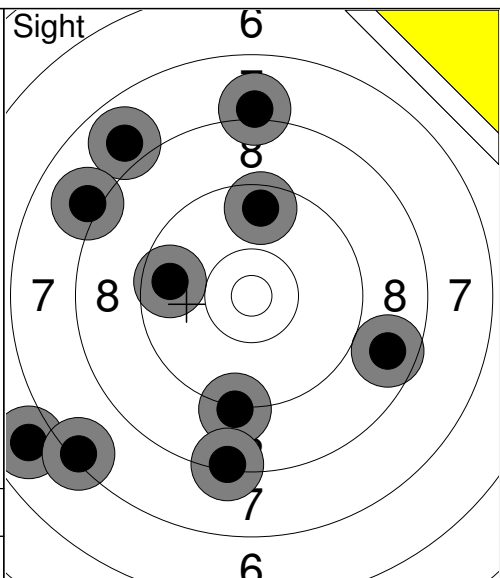

11:	9.2	↓
12:	8.3	↓
13:	7.9	↗
14:	6.8	←
15:	7.3	←
16:	8.1	↑
17:	9.7	←
18:	8.7	→
19:	9.6	↑
20:	8.0	←
Series	79 (0x)	
	0 (0x)	

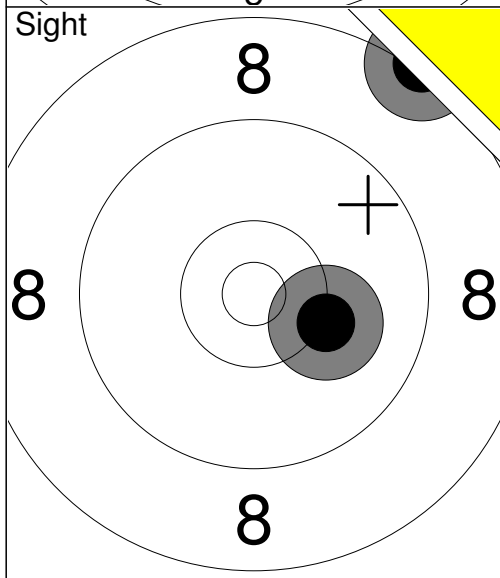

21:	8.1	↗
22:	10.2	→
Series	18 (0x)	
	0 (0x)	

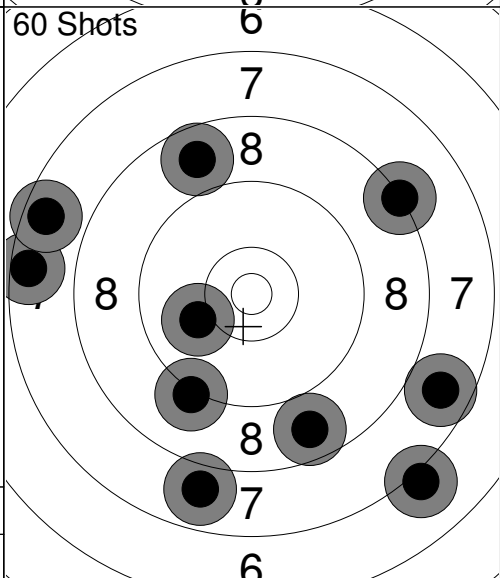

1:	7.5	←
2:	7.6	←
3:	7.9	↓
4:	8.2	↗
5:	8.7	↑
6:	8.7	↓
7:	9.2	↓
8:	10.0	←
9:	7.7	→
10:	7.1	↘
Series	78 (0x)	
	78 (0x)	

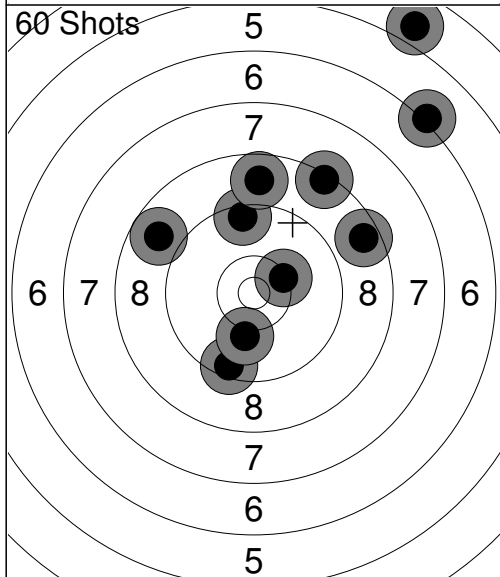

11:	9.4	↑
12:	8.8	↑
13:	8.8	←
14:	9.5	↓
15:	8.6	→
16:	10.1	↓
17:	4.9	↗
18:	8.4	↗
19:	6.2	↗
20:	10.3	↗
Series	80 (0x)	
	158 (0x)	

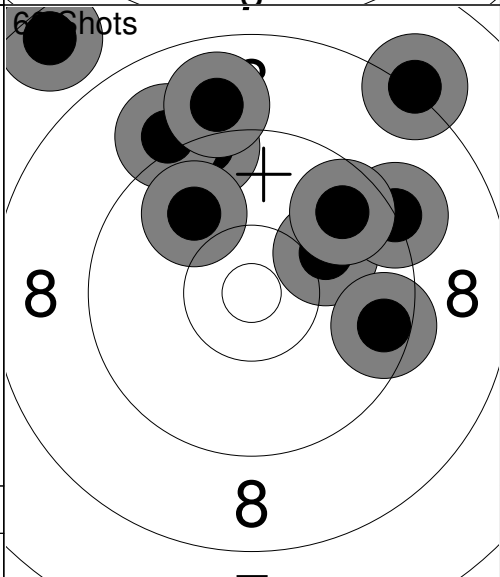

21:	8.2	↗
22:	10.1	↗
23:	9.3	↑
24:	9.2	↗
25:	7.5	↗
26:	9.1	↗
27:	8.9	↑
28:	9.5	→
29:	9.9	↗
30:	9.7	↗
Series	87 (0x)	
	245 (0x)	



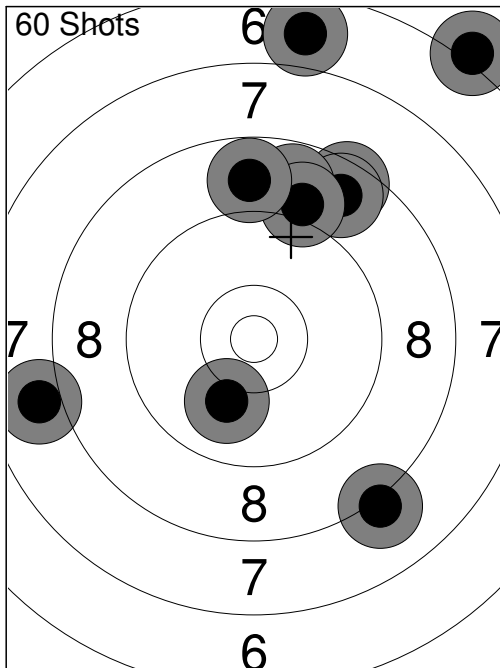

31:	8.5	↗
32:	8.1	↘
33:	8.7	↗
34:	6.8	↑
35:	6.1	↗
36:	7.9	←
37:	8.8	↑
38:	9.0	↑
39:	10.0	↘
40:	8.8	↑

Series	78 (0x)
	323 (0x)

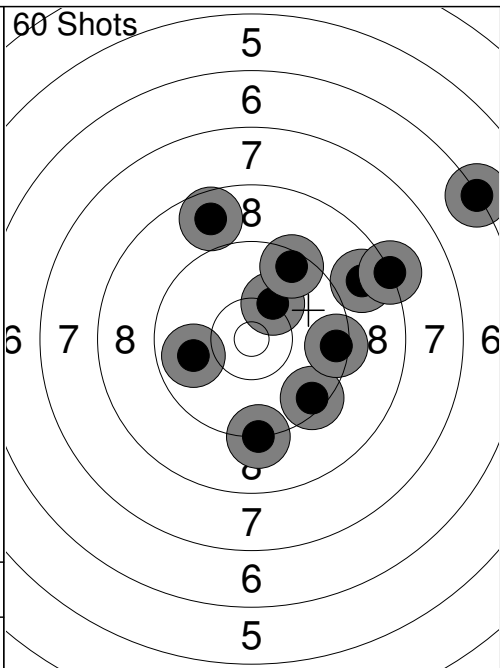

41:	10.2	↗
42:	9.5	↘
43:	9.5	↗
44:	6.2	↗
45:	8.7	↑
46:	9.2	↓
47:	9.5	→
48:	8.8	↗
49:	9.9	←
50:	8.2	↗

Series	85 (0x)
	408 (0x)

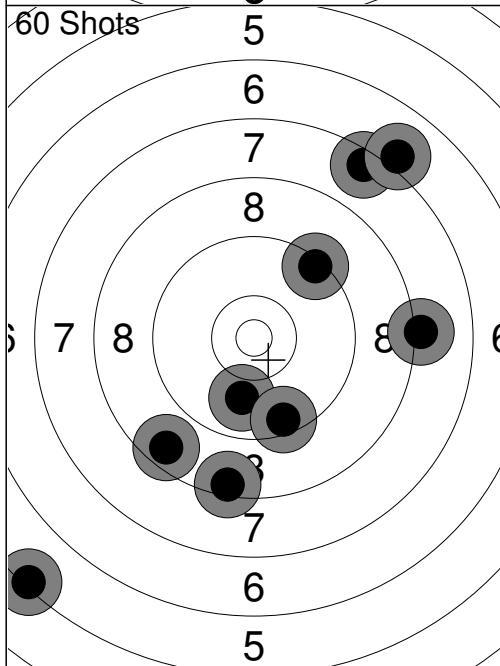

51:	8.4	↓
52:	9.9	↓
53:	9.5	↓
54:	9.3	↗
55:	7.5	↗
56:	8.1	→
57:	5.3	↙
58:	7.0	↗
59:	8.6	↙

Series	70 (0x)
	478 (0x)

--	--

Relay <b>2</b>	Lane <b>9</b>	<b>XU Helen</b>
-------------------	------------------	-----------------

2023 SFC Pistol Nationals	BC	IJ	WP
---------------------------	----	----	----

15.07.2023	PN23AP-Q-1	Alberta Handgun Association
------------	------------	-----------------------------

Comment	Signature
---------	-----------

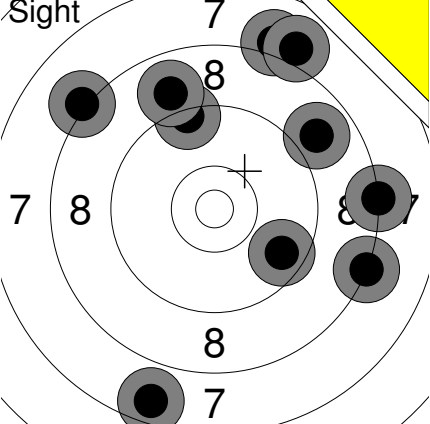
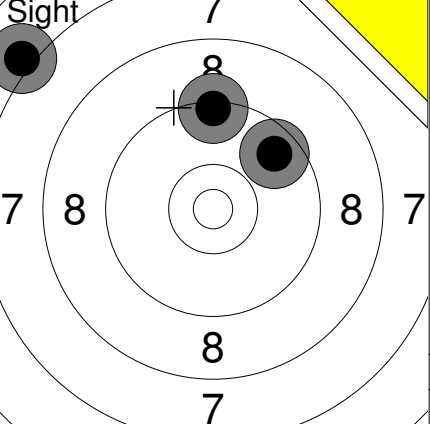
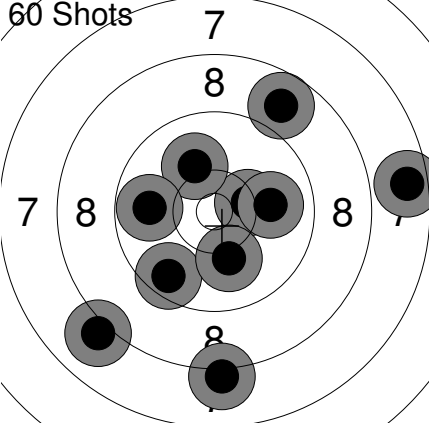
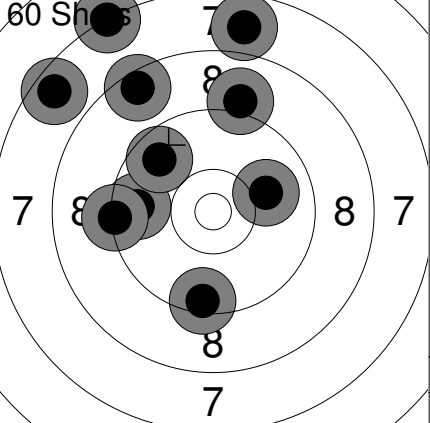
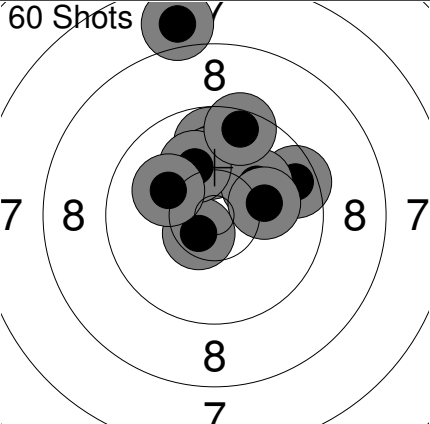
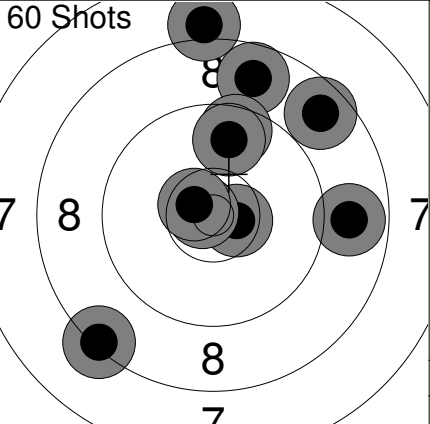
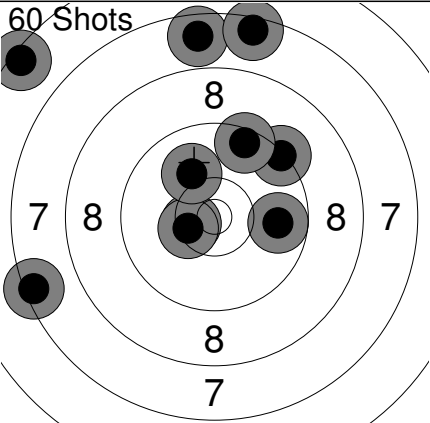
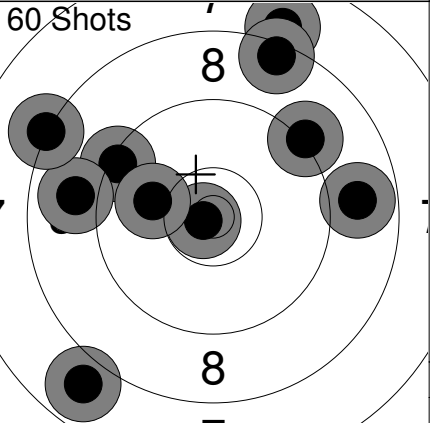
	1: 8.2 →		11: 9.6 ↗
	2: 8.2 ↘		12: 9.3 ↑
	3: 7.6 ↓		13: 7.1 ↖
	4: 9.6 ↘		
	5: 8.0 ↑		
	6: 8.0 ↗		
	7: 8.2 ↗		
	8: 9.3 ↑		
	9: 8.9 ↗		
	10: 8.9 ↑		
	Series 81 (0x)		Series 25 (0x)
	0 (0x)		0 (0x)
	1: 8.8 ↗		11: 10.0 →
	2: 10.4 →		12: 9.7 ←
	3: 9.6 ↘		13: 7.8 ↑
	4: 7.6 →		14: 9.0 ↑
	5: 10.0 →		15: 7.6 ↖
	6: 8.1 ↖		16: 9.7 ↗
	7: 10.1 ↗		17: 9.4 ↓
	8: 10.1 ↓		18: 8.5 ↗
	9: 8.1 ↓		19: 7.2 ↗
	10: 9.8 ←		20: 9.3 ←
	Series 89 (0x)		Series 84 (0x)
	89 (0x)		173 (0x)
	21: 9.8 ↑		31: 10.6x →
	22: 7.9 ↑		32: 10.8x ←
	23: 10.6x ↘		33: 10.6x ↖
	24: 10.1 ↑		34: 8.7 ↗
	25: 9.6 →		35: 8.3 ↘
	26: 10.1 ↗		36: 8.7 ↑
	27: 10.1 →		37: 9.6 ↑
	28: 10.1 ↑		38: 9.8 ↑
	29: 10.1 ↖		39: 8.8 →
	30: 9.5 ↑		40: 8.0 ↑
	Series 94 (1x)		Series 88 (3x)
	267 (1x)		355 (4x)
	41: 9.3 ↗		51: 9.4 ↖
	42: 7.4 ←		52: 9.2 ↗
	43: 7.6 ↑		53: 7.8 ↘
	44: 9.5 ↑		54: 8.0 ↑
	45: 10.5x ←		55: 10.8x ←
	46: 9.8 →		56: 8.9 ←
	47: 7.5 ↑		57: 10.0 ←
	48: 10.4x ←		58: 8.8 →
	49: 10.1 ↗		59: 8.2 ↖
	50: 6.4 ↖		60: 8.4 ↑
	Series 84 (2x)		Series 85 (1x)
	439 (6x)		524 (7x)

Relay **2** Lane **10** **SONG Miya**

2023 SFC Pistol Nationals BC SS WP

15.07.2023 PN23AP-Q-1 Alberta Handgun Association

Comment Signature

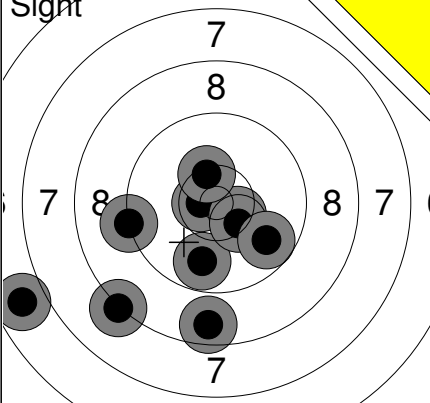
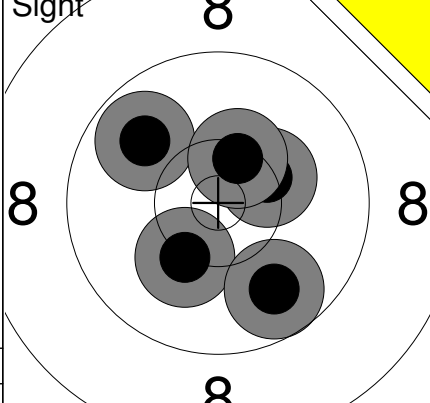
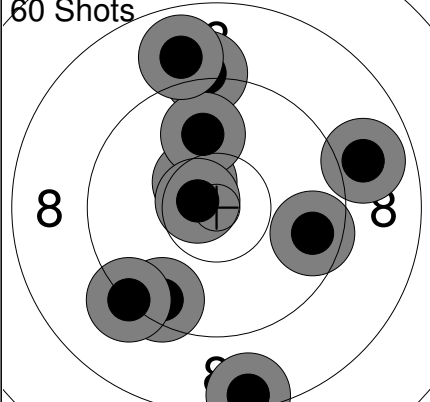
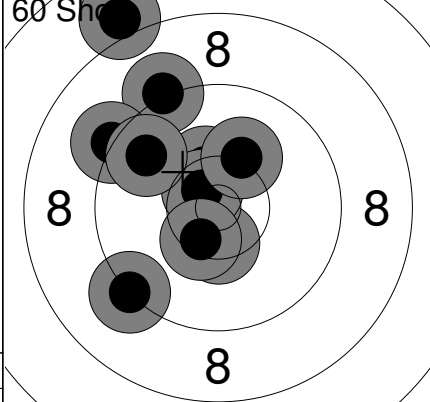
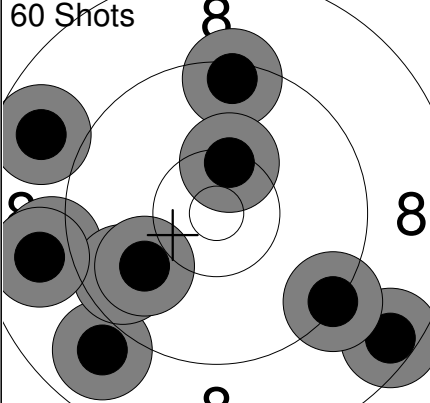
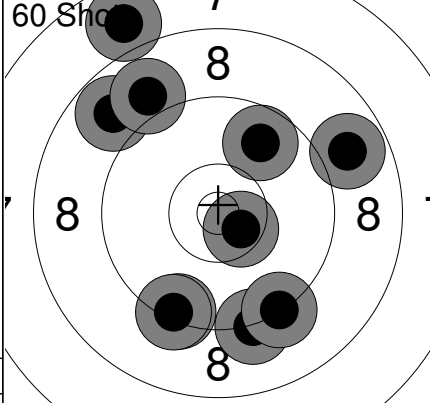
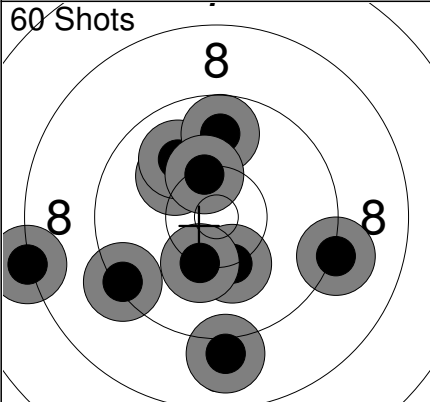
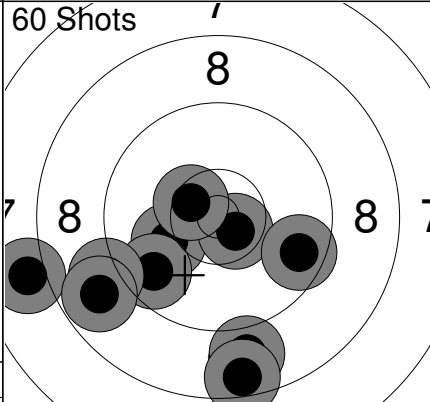
<p>Sight</p> 	<p>1: 6.8 ← 2: 10.6x ← 3: 8.6 ↓ 4: 9.8 ↓ 5: 10.5x ↓ 6: 8.2 ← 7: 9.2 ← 8: 10.4x ↓ 9: 10.4x ↑ 10: 9.8 ↓</p> <p>Series 89 (4x) 0 (0x)</p>	<p>Sight</p> 	<p>11: 9.9 ↖ 12: 10.3 → 13: 10.2 ↓ 14: 9.8 ↓ 15: 10.4x ↑</p> <p>Series 48 (1x) 0 (0x)</p>
<p>60 Shots</p> 	<p>1: 9.2 ↑ 2: 9.5 ↓ 3: 9.6 → 4: 8.9 → 5: 10.5x ↑ 6: 9.3 ← 7: 10.0 ↑ 8: 10.7x ← 9: 8.4 ↓ 10: 8.9 ↑</p> <p>Series 90 (2x) 90 (2x)</p>	<p>60 Shots</p> 	<p>11: 9.2 ↘ 12: 10.3 ↑ 13: 10.4x ↓ 14: 9.2 ↑ 15: 8.0 ↑ 16: 9.2 ↖ 17: 10.6x ↖ 18: 10.4x ↓ 19: 10.2 ↑ 20: 9.7 ↖</p> <p>Series 94 (3x) 184 (5x)</p>
<p>60 Shots</p> 	<p>21: 8.8 ← 22: 9.4 ↑ 23: 9.0 ← 24: 8.5 ↓ 25: 8.9 ↓ 26: 9.7 ← 27: 9.9 ← 28: 9.3 ↓ 29: 10.4x ↑ 30: 8.9 ←</p> <p>Series 87 (1x) 271 (6x)</p>	<p>60 Shots</p> 	<p>31: 8.8 ↖ 32: 10.5x ↓ 33: 9.2 ↓ 34: 8.8 → 35: 8.9 ↖ 36: 9.7 ↑ 37: 9.4 ↓ 38: 7.8 ↖ 39: 9.3 ↓ 40: 9.3 ↓</p> <p>Series 86 (1x) 357 (7x)</p>
<p>60 Shots</p> 	<p>41: 10.2 ↓ 42: 8.2 ← 43: 9.2 → 44: 9.3 ← 45: 10.1 ↖ 46: 10.0 ↖ 47: 9.8 ↑ 48: 10.3 ↑ 49: 9.0 ↓ 50: 10.3 ↓</p> <p>Series 94 (0x) 451 (7x)</p>	<p>60 Shots</p> 	<p>51: 10.1 ↖ 52: 9.7 ↖ 53: 10.6x ↓ 54: 9.0 ← 55: 8.8 ↓ 56: 8.0 ← 57: 8.5 ↓ 58: 8.8 ← 59: 9.6 → 60: 10.5x ↖</p> <p>Series 89 (2x) 540 (9x)</p>

Relay <b>2</b>	Lane <b>11</b>	<b>BRITTON Kim</b>
-------------------	-------------------	--------------------

2023 SFC Pistol Nationals	AB	EX	WP
---------------------------	----	----	----

15.07.2023	PN23AP-Q-1	Alberta Handgun Association
------------	------------	-----------------------------

Comment	Signature
---------	-----------

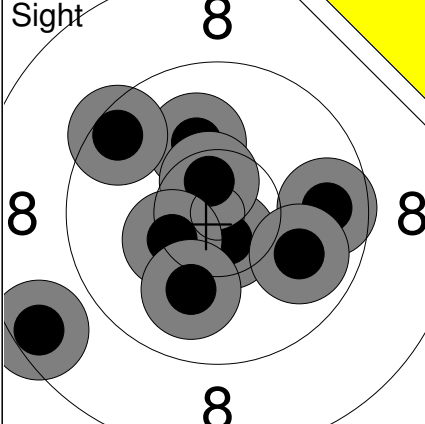
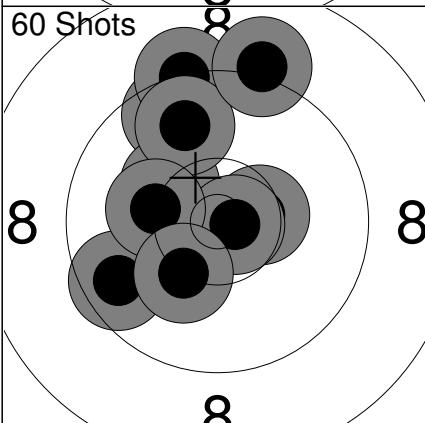
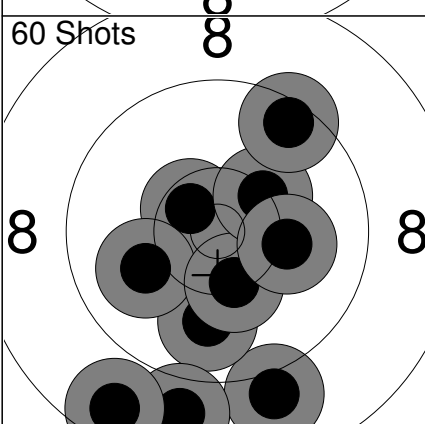
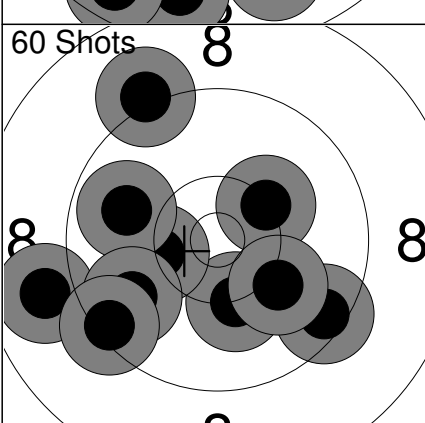
<p>Sight</p> 	<p>60 Shots</p> 	<p>60 Shots</p> 	<p>60 Shots</p> 	<table border="1" style="width:100%; border-collapse: collapse;"> <tr><td>1:</td><td>10.1</td><td>↑</td></tr> <tr><td>2:</td><td>9.5</td><td>↗</td></tr> <tr><td>3:</td><td>9.7</td><td>→</td></tr> <tr><td>4:</td><td>10.6x</td><td>↘</td></tr> <tr><td>5:</td><td>10.6x</td><td>↑</td></tr> <tr><td>6:</td><td>10.4</td><td>←</td></tr> <tr><td>7:</td><td>8.5</td><td>↙</td></tr> <tr><td>8:</td><td>9.9</td><td>↘</td></tr> <tr><td>9:</td><td>10.0</td><td>↓</td></tr> <tr><td colspan="2">Series</td><td>85 (2x)</td></tr> <tr><td colspan="2"></td><td>0 (0x)</td></tr> </table>	1:	10.1	↑	2:	9.5	↗	3:	9.7	→	4:	10.6x	↘	5:	10.6x	↑	6:	10.4	←	7:	8.5	↙	8:	9.9	↘	9:	10.0	↓	Series		85 (2x)			0 (0x)	<table border="1" style="width:100%; border-collapse: collapse;"> <tr><td>1:</td><td>10.4x</td><td>↖</td></tr> <tr><td>2:</td><td>9.7</td><td>↑</td></tr> <tr><td>3:</td><td>9.3</td><td>↓</td></tr> <tr><td>4:</td><td>9.5</td><td>←</td></tr> <tr><td>5:</td><td>9.0</td><td>↙</td></tr> <tr><td>6:</td><td>10.5x</td><td>←</td></tr> <tr><td>7:</td><td>10.5x</td><td>↑</td></tr> <tr><td>8:</td><td>9.8</td><td>↓</td></tr> <tr><td>9:</td><td>9.3</td><td>↘</td></tr> <tr><td>10:</td><td>10.0</td><td>↘</td></tr> <tr><td colspan="2">Series</td><td>94 (3x)</td></tr> <tr><td colspan="2"></td><td>94 (3x)</td></tr> </table>	1:	10.4x	↖	2:	9.7	↑	3:	9.3	↓	4:	9.5	←	5:	9.0	↙	6:	10.5x	←	7:	10.5x	↑	8:	9.8	↓	9:	9.3	↘	10:	10.0	↘	Series		94 (3x)			94 (3x)	<table border="1" style="width:100%; border-collapse: collapse;"> <tr><td>11:</td><td>10.5x</td><td>→</td></tr> <tr><td>12:</td><td>9.6</td><td>↗</td></tr> <tr><td>13:</td><td>10.3</td><td>↗</td></tr> <tr><td>14:</td><td>9.6</td><td>←</td></tr> <tr><td>15:</td><td>10.8x</td><td>→</td></tr> <tr><td>16:</td><td>9.3</td><td>↗</td></tr> <tr><td>17:</td><td>9.8</td><td>↗</td></tr> <tr><td>18:</td><td>10.2</td><td>←</td></tr> <tr><td>19:</td><td>10.2</td><td>↘</td></tr> <tr><td>20:</td><td>9.1</td><td>↑</td></tr> <tr><td colspan="2">Series</td><td>95 (2x)</td></tr> <tr><td colspan="2"></td><td>189 (5x)</td></tr> </table>	11:	10.5x	→	12:	9.6	↗	13:	10.3	↗	14:	9.6	←	15:	10.8x	→	16:	9.3	↗	17:	9.8	↗	18:	10.2	←	19:	10.2	↘	20:	9.1	↑	Series		95 (2x)			189 (5x)	<table border="1" style="width:100%; border-collapse: collapse;"> <tr><td>21:</td><td>10.3</td><td>→</td></tr> <tr><td>22:</td><td>10.3</td><td>→</td></tr> <tr><td>23:</td><td>9.7</td><td>→</td></tr> <tr><td>24:</td><td>8.5</td><td>←</td></tr> <tr><td>25:</td><td>10.6x</td><td>→</td></tr> <tr><td>26:</td><td>10.0</td><td>→</td></tr> <tr><td>27:</td><td>9.9</td><td>↑</td></tr> <tr><td>28:</td><td>10.5x</td><td>↗</td></tr> <tr><td>29:</td><td>9.8</td><td>←</td></tr> <tr><td>30:</td><td>9.6</td><td>↖</td></tr> <tr><td colspan="2">Series</td><td>94 (2x)</td></tr> <tr><td colspan="2"></td><td>283 (7x)</td></tr> </table>	21:	10.3	→	22:	10.3	→	23:	9.7	→	24:	8.5	←	25:	10.6x	→	26:	10.0	→	27:	9.9	↑	28:	10.5x	↗	29:	9.8	←	30:	9.6	↖	Series		94 (2x)			283 (7x)	<table border="1" style="width:100%; border-collapse: collapse;"> <tr><td>31:</td><td>9.0</td><td>↓</td></tr> <tr><td>32:</td><td>9.9</td><td>↓</td></tr> <tr><td>33:</td><td>10.5x</td><td>↗</td></tr> <tr><td>34:</td><td>8.8</td><td>↓</td></tr> <tr><td>35:</td><td>8.6</td><td>↓</td></tr> <tr><td>36:</td><td>10.0</td><td>←</td></tr> <tr><td>37:</td><td>10.3</td><td>↓</td></tr> <tr><td>38:</td><td>10.3</td><td>↗</td></tr> <tr><td>39:</td><td>9.5</td><td>↗</td></tr> <tr><td>40:</td><td>10.2</td><td>→</td></tr> <tr><td colspan="2">Series</td><td>93 (1x)</td></tr> <tr><td colspan="2"></td><td>376 (8x)</td></tr> </table>	31:	9.0	↓	32:	9.9	↓	33:	10.5x	↗	34:	8.8	↓	35:	8.6	↓	36:	10.0	←	37:	10.3	↓	38:	10.3	↗	39:	9.5	↗	40:	10.2	→	Series		93 (1x)			376 (8x)	<table border="1" style="width:100%; border-collapse: collapse;"> <tr><td>41:</td><td>10.0</td><td>↑</td></tr> <tr><td>42:</td><td>10.1</td><td>↑</td></tr> <tr><td>43:</td><td>10.0</td><td>↙</td></tr> <tr><td>44:</td><td>9.6</td><td>←</td></tr> <tr><td>45:</td><td>9.6</td><td>↑</td></tr> <tr><td>46:</td><td>10.4x</td><td>↗</td></tr> <tr><td>47:</td><td>9.8</td><td>→</td></tr> <tr><td>48:</td><td>10.3</td><td>↗</td></tr> <tr><td>49:</td><td>10.4x</td><td>→</td></tr> <tr><td>50:</td><td>9.7</td><td>↑</td></tr> <tr><td colspan="2">Series</td><td>96 (2x)</td></tr> <tr><td colspan="2"></td><td>472 (10x)</td></tr> </table>	41:	10.0	↑	42:	10.1	↑	43:	10.0	↙	44:	9.6	←	45:	9.6	↑	46:	10.4x	↗	47:	9.8	→	48:	10.3	↗	49:	10.4x	→	50:	9.7	↑	Series		96 (2x)			472 (10x)	<table border="1" style="width:100%; border-collapse: collapse;"> <tr><td>51:</td><td>10.2</td><td>↓</td></tr> <tr><td>52:</td><td>10.3</td><td>↗</td></tr> <tr><td>53:</td><td>8.9</td><td>←</td></tr> <tr><td>54:</td><td>10.3</td><td>←</td></tr> <tr><td>55:</td><td>9.5</td><td>↓</td></tr> <tr><td>56:</td><td>10.1</td><td>↓</td></tr> <tr><td>57:</td><td>9.1</td><td>↗</td></tr> <tr><td>58:</td><td>9.9</td><td>←</td></tr> <tr><td>59:</td><td>9.8</td><td>↙</td></tr> <tr><td>60:</td><td>9.4</td><td>↙</td></tr> <tr><td colspan="2">Series</td><td>93 (0x)</td></tr> <tr><td colspan="2"></td><td>565 (10x)</td></tr> </table>	51:	10.2	↓	52:	10.3	↗	53:	8.9	←	54:	10.3	←	55:	9.5	↓	56:	10.1	↓	57:	9.1	↗	58:	9.9	←	59:	9.8	↙	60:	9.4	↙	Series		93 (0x)			565 (10x)
1:	10.1	↑																																																																																																																																																																																																																																																																	
2:	9.5	↗																																																																																																																																																																																																																																																																	
3:	9.7	→																																																																																																																																																																																																																																																																	
4:	10.6x	↘																																																																																																																																																																																																																																																																	
5:	10.6x	↑																																																																																																																																																																																																																																																																	
6:	10.4	←																																																																																																																																																																																																																																																																	
7:	8.5	↙																																																																																																																																																																																																																																																																	
8:	9.9	↘																																																																																																																																																																																																																																																																	
9:	10.0	↓																																																																																																																																																																																																																																																																	
Series		85 (2x)																																																																																																																																																																																																																																																																	
		0 (0x)																																																																																																																																																																																																																																																																	
1:	10.4x	↖																																																																																																																																																																																																																																																																	
2:	9.7	↑																																																																																																																																																																																																																																																																	
3:	9.3	↓																																																																																																																																																																																																																																																																	
4:	9.5	←																																																																																																																																																																																																																																																																	
5:	9.0	↙																																																																																																																																																																																																																																																																	
6:	10.5x	←																																																																																																																																																																																																																																																																	
7:	10.5x	↑																																																																																																																																																																																																																																																																	
8:	9.8	↓																																																																																																																																																																																																																																																																	
9:	9.3	↘																																																																																																																																																																																																																																																																	
10:	10.0	↘																																																																																																																																																																																																																																																																	
Series		94 (3x)																																																																																																																																																																																																																																																																	
		94 (3x)																																																																																																																																																																																																																																																																	
11:	10.5x	→																																																																																																																																																																																																																																																																	
12:	9.6	↗																																																																																																																																																																																																																																																																	
13:	10.3	↗																																																																																																																																																																																																																																																																	
14:	9.6	←																																																																																																																																																																																																																																																																	
15:	10.8x	→																																																																																																																																																																																																																																																																	
16:	9.3	↗																																																																																																																																																																																																																																																																	
17:	9.8	↗																																																																																																																																																																																																																																																																	
18:	10.2	←																																																																																																																																																																																																																																																																	
19:	10.2	↘																																																																																																																																																																																																																																																																	
20:	9.1	↑																																																																																																																																																																																																																																																																	
Series		95 (2x)																																																																																																																																																																																																																																																																	
		189 (5x)																																																																																																																																																																																																																																																																	
21:	10.3	→																																																																																																																																																																																																																																																																	
22:	10.3	→																																																																																																																																																																																																																																																																	
23:	9.7	→																																																																																																																																																																																																																																																																	
24:	8.5	←																																																																																																																																																																																																																																																																	
25:	10.6x	→																																																																																																																																																																																																																																																																	
26:	10.0	→																																																																																																																																																																																																																																																																	
27:	9.9	↑																																																																																																																																																																																																																																																																	
28:	10.5x	↗																																																																																																																																																																																																																																																																	
29:	9.8	←																																																																																																																																																																																																																																																																	
30:	9.6	↖																																																																																																																																																																																																																																																																	
Series		94 (2x)																																																																																																																																																																																																																																																																	
		283 (7x)																																																																																																																																																																																																																																																																	
31:	9.0	↓																																																																																																																																																																																																																																																																	
32:	9.9	↓																																																																																																																																																																																																																																																																	
33:	10.5x	↗																																																																																																																																																																																																																																																																	
34:	8.8	↓																																																																																																																																																																																																																																																																	
35:	8.6	↓																																																																																																																																																																																																																																																																	
36:	10.0	←																																																																																																																																																																																																																																																																	
37:	10.3	↓																																																																																																																																																																																																																																																																	
38:	10.3	↗																																																																																																																																																																																																																																																																	
39:	9.5	↗																																																																																																																																																																																																																																																																	
40:	10.2	→																																																																																																																																																																																																																																																																	
Series		93 (1x)																																																																																																																																																																																																																																																																	
		376 (8x)																																																																																																																																																																																																																																																																	
41:	10.0	↑																																																																																																																																																																																																																																																																	
42:	10.1	↑																																																																																																																																																																																																																																																																	
43:	10.0	↙																																																																																																																																																																																																																																																																	
44:	9.6	←																																																																																																																																																																																																																																																																	
45:	9.6	↑																																																																																																																																																																																																																																																																	
46:	10.4x	↗																																																																																																																																																																																																																																																																	
47:	9.8	→																																																																																																																																																																																																																																																																	
48:	10.3	↗																																																																																																																																																																																																																																																																	
49:	10.4x	→																																																																																																																																																																																																																																																																	
50:	9.7	↑																																																																																																																																																																																																																																																																	
Series		96 (2x)																																																																																																																																																																																																																																																																	
		472 (10x)																																																																																																																																																																																																																																																																	
51:	10.2	↓																																																																																																																																																																																																																																																																	
52:	10.3	↗																																																																																																																																																																																																																																																																	
53:	8.9	←																																																																																																																																																																																																																																																																	
54:	10.3	←																																																																																																																																																																																																																																																																	
55:	9.5	↓																																																																																																																																																																																																																																																																	
56:	10.1	↓																																																																																																																																																																																																																																																																	
57:	9.1	↗																																																																																																																																																																																																																																																																	
58:	9.9	←																																																																																																																																																																																																																																																																	
59:	9.8	↙																																																																																																																																																																																																																																																																	
60:	9.4	↙																																																																																																																																																																																																																																																																	
Series		93 (0x)																																																																																																																																																																																																																																																																	
		565 (10x)																																																																																																																																																																																																																																																																	

Relay <b>2</b>	Lane <b>12</b>	<b>GUSTAFSON Liz</b>
-------------------	-------------------	----------------------

2023 SFC Pistol Nationals	AB	EX	WP
---------------------------	----	----	----

15.07.2023	PN23AP-Q-1	Alberta Handgun Association
------------	------------	-----------------------------

Comment	Signature
---------	-----------

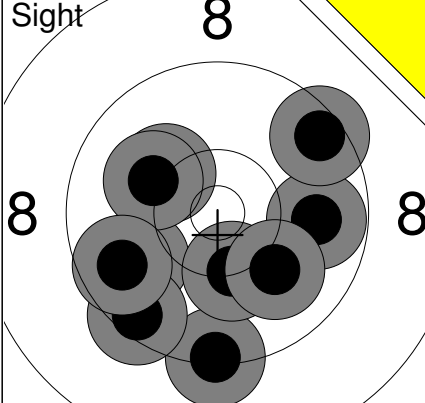
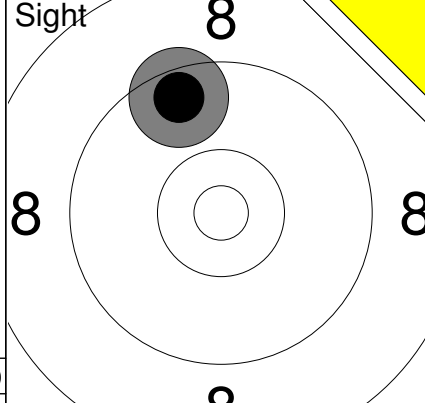
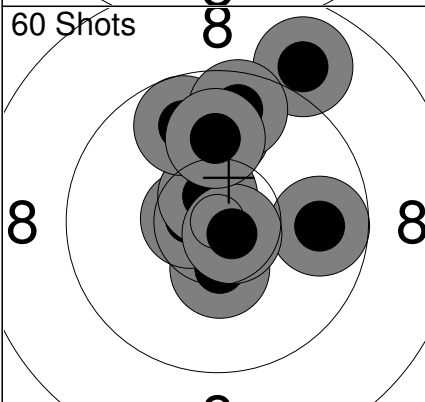
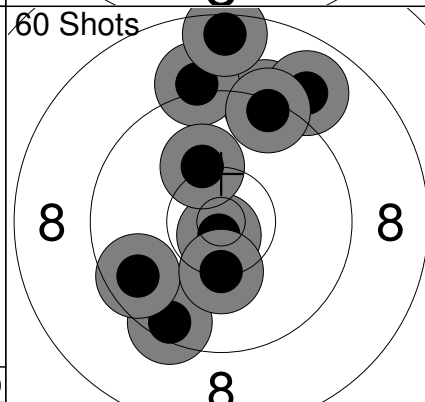
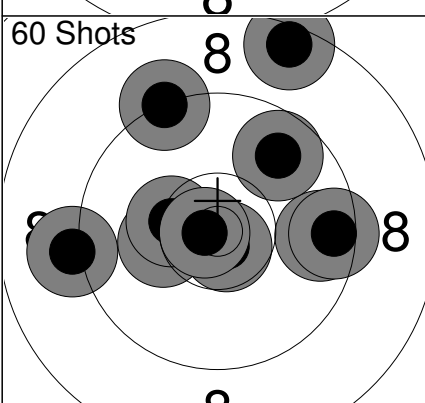
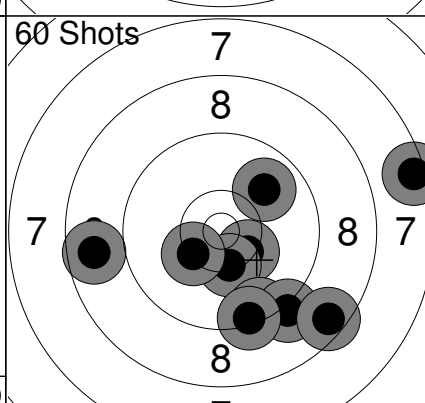
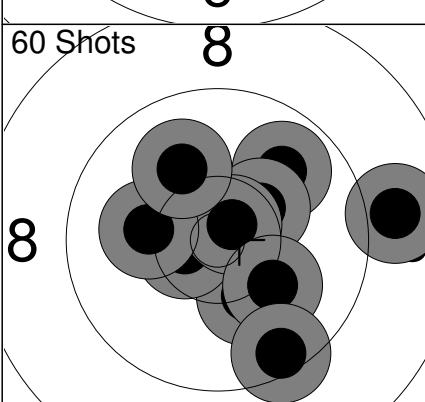
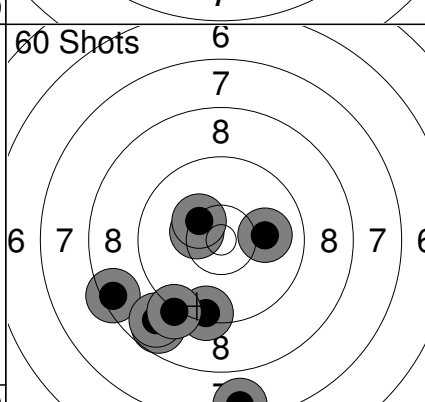
<p>Sight</p> 	<p>1: 9.9 ←</p> <p>2: 9.8 →</p> <p>3: 9.3 ↓</p> <p>4: 10.3 ↓</p> <p>5: 9.5 ←</p> <p>6: 10.2 ↗</p> <p>7: 10.1 ↗</p> <p>8: 9.5 →</p> <p>9: 10.0 ↓</p> <p>10: 9.7 ←</p> <p>Series 94 (0x)</p> <p>0 (0x)</p>	<p>Sight</p>  <p>11: 9.6 ↗</p> <p>Series 9 (0x)</p> <p>0 (0x)</p>	
<p>60 Shots</p> 	<p>1: 10.4x ↓</p> <p>2: 9.9 ↑</p> <p>3: 10.6x ←</p> <p>4: 8.9 ↗</p> <p>5: 10.6x ↗</p> <p>6: 9.8 ↗</p> <p>7: 9.7 ↗</p> <p>8: 9.8 →</p> <p>9: 10.7x ↓</p> <p>10: 10.0 ↑</p> <p>Series 94 (4x)</p> <p>94 (4x)</p>	<p>60 Shots</p>  <p>11: 9.5 ↓</p> <p>12: 9.3 ↑</p> <p>13: 9.6 ←</p> <p>14: 10.8x ↓</p> <p>15: 9.1 ↑</p> <p>16: 8.5 ↑</p> <p>17: 10.2 ↗</p> <p>18: 10.3 ↓</p> <p>19: 8.9 ↗</p> <p>20: 9.4 ↗</p> <p>Series 91 (1x)</p> <p>185 (5x)</p>	
<p>60 Shots</p> 	<p>21: 9.7 →</p> <p>22: 9.7 ↗</p> <p>23: 9.2 ↗</p> <p>24: 10.3 ←</p> <p>25: 9.1 ←</p> <p>26: 10.7x ↓</p> <p>27: 10.4x ←</p> <p>28: 9.5 →</p> <p>29: 8.5 ↑</p> <p>30: 10.8x ←</p> <p>Series 93 (3x)</p> <p>278 (8x)</p>	<p>60 Shots</p>  <p>31: 10.4x ↘</p> <p>32: 10.3 ↓</p> <p>33: 9.9 ↗</p> <p>34: 8.7 ←</p> <p>35: 9.4 ↓</p> <p>36: 9.1 ↓</p> <p>37: 7.4 →</p> <p>38: 10.3 ←</p> <p>39: 8.5 ↘</p> <p>40: 9.3 ↓</p> <p>Series 89 (1x)</p> <p>367 (9x)</p>	
<p>60 Shots</p> 	<p>41: 9.9 ↗</p> <p>42: 10.3 ↗</p> <p>43: 10.2 ↓</p> <p>44: 10.6x ←</p> <p>45: 10.7x ↗</p> <p>46: 10.1 ↓</p> <p>47: 8.9 →</p> <p>48: 10.2 ←</p> <p>49: 10.0 ↗</p> <p>50: 9.5 ↓</p> <p>Series 96 (2x)</p> <p>463 (11x)</p>	<p>60 Shots</p>  <p>51: 8.8 ↓</p> <p>52: 10.4x ←</p> <p>53: 10.3 ↗</p> <p>54: 8.4 ←</p> <p>55: 7.5 ↓</p> <p>56: 10.0 →</p> <p>57: 8.8 ↓</p> <p>58: 6.9 ↓</p> <p>59: 9.4 ↓</p> <p>60: 9.2 ↓</p> <p>Series 85 (1x)</p> <p>548 (12x)</p>	

<p>Sight</p>	<table border="1" style="width:100%; border-collapse: collapse;"> <tr><td>1:</td><td>8.1</td><td>↗</td></tr> <tr><td>2:</td><td>9.3</td><td>↗</td></tr> <tr><td>3:</td><td>9.6</td><td>↗</td></tr> <tr><td>4:</td><td>9.5</td><td>↗</td></tr> <tr><td>5:</td><td>10.0</td><td>↘</td></tr> <tr><td>6:</td><td>10.9x</td><td>↘</td></tr> <tr><td>7:</td><td>10.4x</td><td>↘</td></tr> <tr><td colspan="2">Series</td><td>65 (2x)</td></tr> <tr><td colspan="2"></td><td>0 (0x)</td></tr> </table>	1:	8.1	↗	2:	9.3	↗	3:	9.6	↗	4:	9.5	↗	5:	10.0	↘	6:	10.9x	↘	7:	10.4x	↘	Series		65 (2x)			0 (0x)	<p>60 Shots</p> <table border="1" style="width:100%; border-collapse: collapse;"> <tr><td>1:</td><td>10.0</td><td>↗</td></tr> <tr><td>2:</td><td>9.2</td><td>↘</td></tr> <tr><td>3:</td><td>10.4x</td><td>↖</td></tr> <tr><td>4:</td><td>8.8</td><td>→</td></tr> <tr><td>5:</td><td>9.1</td><td>→</td></tr> <tr><td>6:</td><td>8.6</td><td>↘</td></tr> <tr><td>7:</td><td>10.4x</td><td>↘</td></tr> <tr><td>8:</td><td>9.8</td><td>↘</td></tr> <tr><td>9:</td><td>10.1</td><td>←</td></tr> <tr><td>10:</td><td>9.2</td><td>→</td></tr> <tr><td colspan="2">Series</td><td>92 (2x)</td></tr> <tr><td colspan="2"></td><td>92 (2x)</td></tr> </table>	1:	10.0	↗	2:	9.2	↘	3:	10.4x	↖	4:	8.8	→	5:	9.1	→	6:	8.6	↘	7:	10.4x	↘	8:	9.8	↘	9:	10.1	←	10:	9.2	→	Series		92 (2x)			92 (2x)										
1:	8.1	↗																																																																									
2:	9.3	↗																																																																									
3:	9.6	↗																																																																									
4:	9.5	↗																																																																									
5:	10.0	↘																																																																									
6:	10.9x	↘																																																																									
7:	10.4x	↘																																																																									
Series		65 (2x)																																																																									
		0 (0x)																																																																									
1:	10.0	↗																																																																									
2:	9.2	↘																																																																									
3:	10.4x	↖																																																																									
4:	8.8	→																																																																									
5:	9.1	→																																																																									
6:	8.6	↘																																																																									
7:	10.4x	↘																																																																									
8:	9.8	↘																																																																									
9:	10.1	←																																																																									
10:	9.2	→																																																																									
Series		92 (2x)																																																																									
		92 (2x)																																																																									
<p>60 Shots</p>	<table border="1" style="width:100%; border-collapse: collapse;"> <tr><td>11:</td><td>10.5x</td><td>↖</td></tr> <tr><td>12:</td><td>10.6x</td><td>→</td></tr> <tr><td>13:</td><td>9.8</td><td>→</td></tr> <tr><td>14:</td><td>10.1</td><td>→</td></tr> <tr><td>15:</td><td>9.7</td><td>→</td></tr> <tr><td>16:</td><td>10.3</td><td>↗</td></tr> <tr><td>17:</td><td>10.4x</td><td>↗</td></tr> <tr><td>18:</td><td>9.2</td><td>↘</td></tr> <tr><td>19:</td><td>9.7</td><td>↗</td></tr> <tr><td>20:</td><td>9.4</td><td>↗</td></tr> <tr><td colspan="2">Series</td><td>95 (3x)</td></tr> <tr><td colspan="2"></td><td>187 (5x)</td></tr> </table>	11:	10.5x	↖	12:	10.6x	→	13:	9.8	→	14:	10.1	→	15:	9.7	→	16:	10.3	↗	17:	10.4x	↗	18:	9.2	↘	19:	9.7	↗	20:	9.4	↗	Series		95 (3x)			187 (5x)	<p>60 Shots</p> <table border="1" style="width:100%; border-collapse: collapse;"> <tr><td>21:</td><td>9.3</td><td>↘</td></tr> <tr><td>22:</td><td>9.9</td><td>↗</td></tr> <tr><td>23:</td><td>8.9</td><td>↖</td></tr> <tr><td>24:</td><td>10.6x</td><td>↘</td></tr> <tr><td>25:</td><td>9.8</td><td>↗</td></tr> <tr><td>26:</td><td>10.7x</td><td>↖</td></tr> <tr><td>27:</td><td>10.5x</td><td>↘</td></tr> <tr><td>28:</td><td>9.7</td><td>←</td></tr> <tr><td>29:</td><td>9.3</td><td>↘</td></tr> <tr><td>30:</td><td>10.4x</td><td>↘</td></tr> <tr><td colspan="2">Series</td><td>93 (4x)</td></tr> <tr><td colspan="2"></td><td>280 (9x)</td></tr> </table>	21:	9.3	↘	22:	9.9	↗	23:	8.9	↖	24:	10.6x	↘	25:	9.8	↗	26:	10.7x	↖	27:	10.5x	↘	28:	9.7	←	29:	9.3	↘	30:	10.4x	↘	Series		93 (4x)			280 (9x)	
11:	10.5x	↖																																																																									
12:	10.6x	→																																																																									
13:	9.8	→																																																																									
14:	10.1	→																																																																									
15:	9.7	→																																																																									
16:	10.3	↗																																																																									
17:	10.4x	↗																																																																									
18:	9.2	↘																																																																									
19:	9.7	↗																																																																									
20:	9.4	↗																																																																									
Series		95 (3x)																																																																									
		187 (5x)																																																																									
21:	9.3	↘																																																																									
22:	9.9	↗																																																																									
23:	8.9	↖																																																																									
24:	10.6x	↘																																																																									
25:	9.8	↗																																																																									
26:	10.7x	↖																																																																									
27:	10.5x	↘																																																																									
28:	9.7	←																																																																									
29:	9.3	↘																																																																									
30:	10.4x	↘																																																																									
Series		93 (4x)																																																																									
		280 (9x)																																																																									
<p>60 Shots</p>	<table border="1" style="width:100%; border-collapse: collapse;"> <tr><td>31:</td><td>10.4x</td><td>↗</td></tr> <tr><td>32:</td><td>8.9</td><td>↗</td></tr> <tr><td>33:</td><td>7.6</td><td>↗</td></tr> <tr><td>34:</td><td>10.7x</td><td>↘</td></tr> <tr><td>35:</td><td>7.6</td><td>→</td></tr> <tr><td>36:</td><td>9.1</td><td>↗</td></tr> <tr><td>37:</td><td>9.9</td><td>↘</td></tr> <tr><td>38:</td><td>9.9</td><td>↗</td></tr> <tr><td>39:</td><td>10.5x</td><td>↗</td></tr> <tr><td>40:</td><td>7.8</td><td>↗</td></tr> <tr><td colspan="2">Series</td><td>86 (3x)</td></tr> <tr><td colspan="2"></td><td>366 (12x)</td></tr> </table>	31:	10.4x	↗	32:	8.9	↗	33:	7.6	↗	34:	10.7x	↘	35:	7.6	→	36:	9.1	↗	37:	9.9	↘	38:	9.9	↗	39:	10.5x	↗	40:	7.8	↗	Series		86 (3x)			366 (12x)	<p>60 Shots</p> <table border="1" style="width:100%; border-collapse: collapse;"> <tr><td>41:</td><td>10.5x</td><td>↘</td></tr> <tr><td>42:</td><td>10.9x</td><td>↖</td></tr> <tr><td>43:</td><td>9.7</td><td>↘</td></tr> <tr><td>44:</td><td>9.5</td><td>↗</td></tr> <tr><td>45:</td><td>8.8</td><td>↖</td></tr> <tr><td>46:</td><td>9.9</td><td>↗</td></tr> <tr><td>47:</td><td>9.1</td><td>→</td></tr> <tr><td>48:</td><td>9.2</td><td>↗</td></tr> <tr><td>49:</td><td>9.3</td><td>↗</td></tr> <tr><td>50:</td><td>10.3</td><td>→</td></tr> <tr><td colspan="2">Series</td><td>92 (2x)</td></tr> <tr><td colspan="2"></td><td>458 (14x)</td></tr> </table>	41:	10.5x	↘	42:	10.9x	↖	43:	9.7	↘	44:	9.5	↗	45:	8.8	↖	46:	9.9	↗	47:	9.1	→	48:	9.2	↗	49:	9.3	↗	50:	10.3	→	Series		92 (2x)			458 (14x)	
31:	10.4x	↗																																																																									
32:	8.9	↗																																																																									
33:	7.6	↗																																																																									
34:	10.7x	↘																																																																									
35:	7.6	→																																																																									
36:	9.1	↗																																																																									
37:	9.9	↘																																																																									
38:	9.9	↗																																																																									
39:	10.5x	↗																																																																									
40:	7.8	↗																																																																									
Series		86 (3x)																																																																									
		366 (12x)																																																																									
41:	10.5x	↘																																																																									
42:	10.9x	↖																																																																									
43:	9.7	↘																																																																									
44:	9.5	↗																																																																									
45:	8.8	↖																																																																									
46:	9.9	↗																																																																									
47:	9.1	→																																																																									
48:	9.2	↗																																																																									
49:	9.3	↗																																																																									
50:	10.3	→																																																																									
Series		92 (2x)																																																																									
		458 (14x)																																																																									
<p>60 Shots</p>	<table border="1" style="width:100%; border-collapse: collapse;"> <tr><td>51:</td><td>9.6</td><td>↘</td></tr> <tr><td>52:</td><td>9.4</td><td>→</td></tr> <tr><td>53:</td><td>10.1</td><td>↘</td></tr> <tr><td>54:</td><td>9.7</td><td>↘</td></tr> <tr><td>55:</td><td>8.4</td><td>↗</td></tr> <tr><td>56:</td><td>8.6</td><td>↗</td></tr> <tr><td>57:</td><td>8.5</td><td>↗</td></tr> <tr><td>58:</td><td>10.8x</td><td>↖</td></tr> <tr><td>59:</td><td>10.1</td><td>↘</td></tr> <tr><td>60:</td><td>8.9</td><td>↖</td></tr> <tr><td colspan="2">Series</td><td>89 (1x)</td></tr> <tr><td colspan="2"></td><td>547 (15x)</td></tr> </table>	51:	9.6	↘	52:	9.4	→	53:	10.1	↘	54:	9.7	↘	55:	8.4	↗	56:	8.6	↗	57:	8.5	↗	58:	10.8x	↖	59:	10.1	↘	60:	8.9	↖	Series		89 (1x)			547 (15x)																																						
51:	9.6	↘																																																																									
52:	9.4	→																																																																									
53:	10.1	↘																																																																									
54:	9.7	↘																																																																									
55:	8.4	↗																																																																									
56:	8.6	↗																																																																									
57:	8.5	↗																																																																									
58:	10.8x	↖																																																																									
59:	10.1	↘																																																																									
60:	8.9	↖																																																																									
Series		89 (1x)																																																																									
		547 (15x)																																																																									



Relay **2** Lane **14** **KRANENBURG Lori**

2023 SFC Pistol Nationals ON EX WP

15.07.2023 PN23AP-Q-1 Alberta Handgun Association

Comment Signature

<b>Sight</b> 	1: 10.7x ↗ 2: 9.7 ← 3: 9.2 → 4: 9.5 → 5: 7.6 ← 6: 8.5 ↗ 7: 10.8x ↙ 8: 8.3 ← 9: 9.9 ↙ 10: 9.3 ↑	<b>60 Shots</b> 	1: 9.1 ← 2: 6.9 ↓ 3: 9.9 ↙ 4: 9.2 ← 5: 10.5x ↙ 6: 9.4 ↙ 7: 10.1 ← 8: 10.5x → 9: 9.3 ↗ 10: 10.0 →
	Series 88 (2x) 0 (0x)		Series 91 (2x) 91 (2x)
<b>60 Shots</b> 	11: 9.4 ↙ 12: 8.5 ← 13: 9.8 → 14: 8.7 ↑ 15: 9.7 ↗ 16: 9.5 → 17: 9.3 ↙ 18: 9.0 ↗ 19: 10.4x ↑ 20: 8.7 ↘	<b>60 Shots</b> 	21: 9.7 ↑ 22: 8.8 ↙ 23: 9.9 ↗ 24: 9.6 ↗ 25: 7.7 ↙ 26: 10.3 ↙ 27: 10.3 ↙ 28: 8.7 ↘ 29: 10.1 ↑ 30: 6.7 ↗
	Series 88 (1x) 179 (3x)		Series 86 (0x) 265 (3x)
<b>60 Shots</b> 	31: 9.6 ↗ 32: 9.2 → 33: 8.4 ← 34: 10.4x → 35: 9.0 → 36: 8.7 ↗ 37: 10.8x ← 38: 8.8 ↙ 39: 8.1 ↗ 40: 9.8 ←	<b>60 Shots</b> 	41: 10.4x ↙ 42: 10.1 → 43: 10.4x ← 44: 10.4x ← 45: 10.0 ← 46: 10.8x ← 47: 8.6 ← 48: 10.3 ↘ 49: 9.0 ↘ 50: 10.5x ↗
	Series 88 (2x) 353 (5x)		Series 97 (5x) 450 (10x)
<b>60 Shots</b> 	51: 9.7 ← 52: 10.2 ↓ 53: 10.6x ↙ 54: 8.4 → 55: 9.2 ← 56: 10.0 → 57: 10.3 ↗ 58: 9.2 ← 59: 8.5 ↗ 60: 8.6 ←		
	Series 91 (1x) 541 (11x)		

Relay **2** Lane **15** **LE SIEUR Audrey anne**

2023 SFC Pistol Nationals QC EX WP

15.07.2023 PN23AP-Q-1 Alberta Handgun Association

Comment Signature

	1: 10.0 ↘ 2: 10.6x → 3: 9.4 → 4: 10.1 ↘ 5: 8.5 ↗ 6: 9.9 ↘ 7: 8.2 ↘ 8: 9.8 → 9: 9.3 ↘ 10: 10.0 ←		1: 10.5x ↑ 2: 10.0 ↘ 3: 9.8 → 4: 9.7 ↘ 5: 8.4 → 6: 9.5 → 7: 9.7 ↘ 8: 10.7x ← 9: 10.0 ↘ 10: 9.9 ↘
	Series 92 ( 1x) 0 ( 0x)		Series 93 ( 2x) 93 ( 2x)

	11: 9.4 ↘ 12: 10.6x ↗ 13: 10.8x ↘ 14: 9.8 ↘ 15: 10.3 ↗ 16: 9.1 → 17: 9.8 ↑ 18: 9.1 ↘ 19: 10.7x ↗ 20: 9.0 →		21: 10.1 → 22: 10.6x ↗ 23: 10.4x ↑ 24: 10.1 ↘ 25: 10.6x ↑ 26: 8.5 ↗ 27: 8.5 ↘ 28: 9.5 ↑ 29: 7.8 → 30: 10.4x ↗
	Series 94 ( 3x) 187 ( 5x)		Series 92 ( 4x) 279 ( 9x)

	31: 10.1 ↘ 32: 9.8 → 33: 7.7 → 34: 9.5 → 35: 7.7 → 36: 8.6 → 37: 10.0 ↘ 38: 7.1 → 39: 9.7 ↗ 40: 9.7 ↗		41: 8.2 → 42: 9.5 → 43: 9.9 → 44: 10.2 → 45: 10.3 ← 46: 9.0 → 47: 10.0 → 48: 9.2 → 49: 8.0 → 50: 9.8 →
	Series 85 ( 0x) 364 ( 9x)		Series 91 ( 0x) 455 ( 9x)

	51: 9.4 → 52: 9.8 ↘ 53: 10.5x ↗ 54: 8.0 → 55: 10.1 ↘ 56: 6.9 ↘ 57: 7.5 → 58: 7.6 → 59: 10.1 ↘ 60: 10.2 ↘		
	Series 86 ( 1x) 541 ( 10x)		

Comment	Signature
---------	-----------

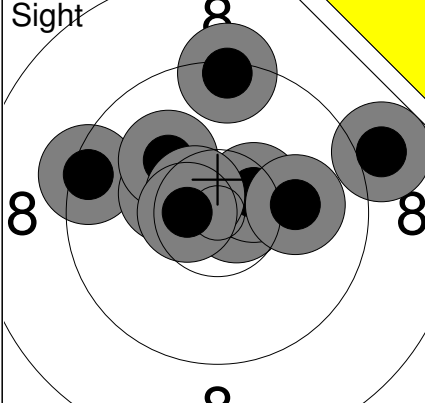
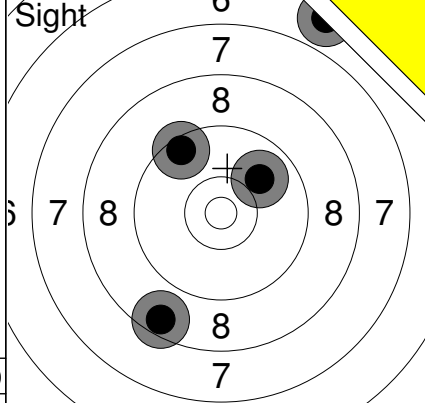
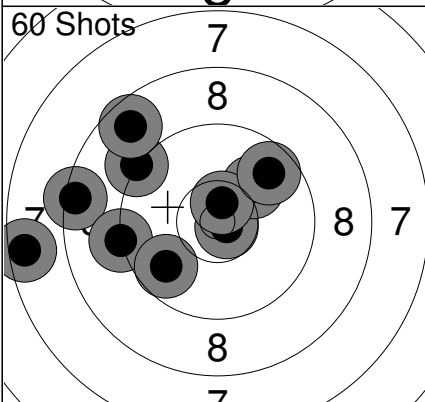
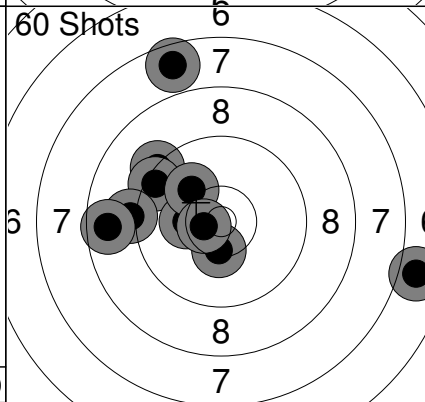
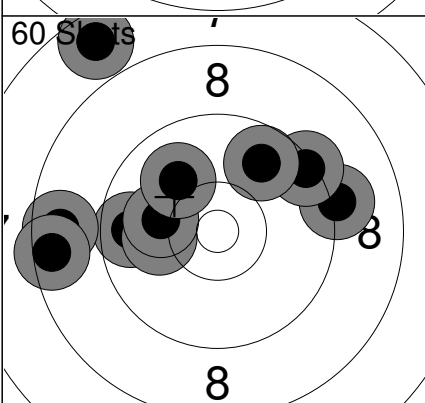
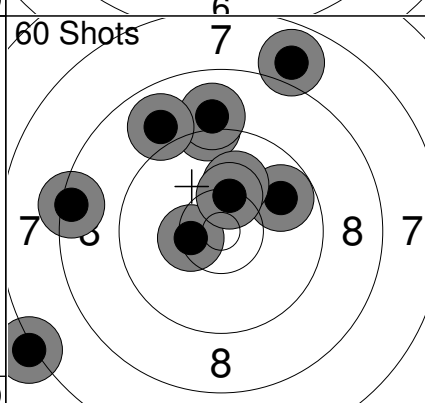
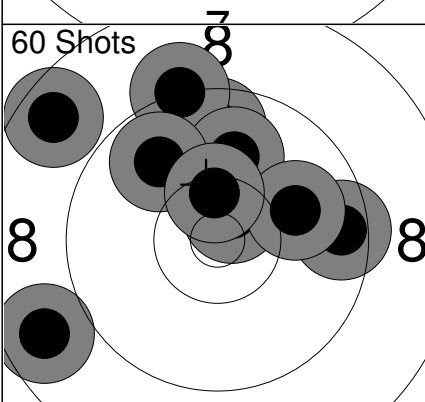
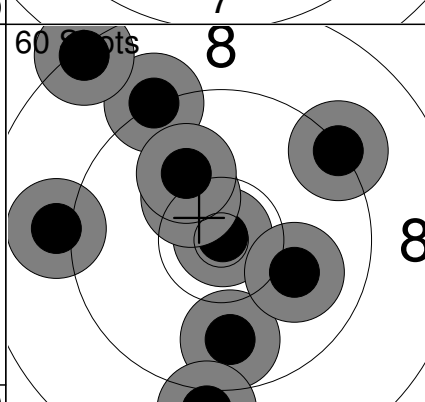
<p>Sight</p> 	<table border="1" style="width:100%; border-collapse: collapse;"> <tr><td>1:</td><td>9.0</td><td>→</td></tr> <tr><td>2:</td><td>10.7x</td><td>→</td></tr> <tr><td>3:</td><td>10.5x</td><td>→</td></tr> <tr><td>4:</td><td>9.4</td><td>←</td></tr> <tr><td>5:</td><td>10.3</td><td>←</td></tr> <tr><td>6:</td><td>10.1</td><td>↗</td></tr> <tr><td>7:</td><td>9.4</td><td>↑</td></tr> <tr><td>8:</td><td>10.1</td><td>→</td></tr> <tr><td>9:</td><td>10.6x</td><td>↗</td></tr> <tr><td>10:</td><td>10.6x</td><td>←</td></tr> <tr><td colspan="2">Series</td><td>97 (4x)</td></tr> <tr><td colspan="2"></td><td>0 (0x)</td></tr> </table>	1:	9.0	→	2:	10.7x	→	3:	10.5x	→	4:	9.4	←	5:	10.3	←	6:	10.1	↗	7:	9.4	↑	8:	10.1	→	9:	10.6x	↗	10:	10.6x	←	Series		97 (4x)			0 (0x)	<p>Sight</p>  <table border="1" style="width:100%; border-collapse: collapse;"> <tr><td>11:</td><td>6.6</td><td>↗</td></tr> <tr><td>12:</td><td>9.9</td><td>↗</td></tr> <tr><td>13:</td><td>8.5</td><td>↓</td></tr> <tr><td>14:</td><td>9.5</td><td>↖</td></tr> <tr><td colspan="2">Series</td><td>32 (0x)</td></tr> <tr><td colspan="2"></td><td>0 (0x)</td></tr> </table>	11:	6.6	↗	12:	9.9	↗	13:	8.5	↓	14:	9.5	↖	Series		32 (0x)			0 (0x)																		
1:	9.0	→																																																																								
2:	10.7x	→																																																																								
3:	10.5x	→																																																																								
4:	9.4	←																																																																								
5:	10.3	←																																																																								
6:	10.1	↗																																																																								
7:	9.4	↑																																																																								
8:	10.1	→																																																																								
9:	10.6x	↗																																																																								
10:	10.6x	←																																																																								
Series		97 (4x)																																																																								
		0 (0x)																																																																								
11:	6.6	↗																																																																								
12:	9.9	↗																																																																								
13:	8.5	↓																																																																								
14:	9.5	↖																																																																								
Series		32 (0x)																																																																								
		0 (0x)																																																																								
<p>60 Shots</p> 	<table border="1" style="width:100%; border-collapse: collapse;"> <tr><td>1:</td><td>9.2</td><td>↖</td></tr> <tr><td>2:</td><td>8.7</td><td>↗</td></tr> <tr><td>3:</td><td>8.4</td><td>←</td></tr> <tr><td>4:</td><td>10.8x</td><td>↘</td></tr> <tr><td>5:</td><td>10.1</td><td>↗</td></tr> <tr><td>6:</td><td>7.5</td><td>←</td></tr> <tr><td>7:</td><td>10.6x</td><td>↑</td></tr> <tr><td>8:</td><td>9.7</td><td>↗</td></tr> <tr><td>9:</td><td>9.2</td><td>←</td></tr> <tr><td>10:</td><td>9.8</td><td>↘</td></tr> <tr><td colspan="2">Series</td><td>89 (2x)</td></tr> <tr><td colspan="2"></td><td>89 (2x)</td></tr> </table>	1:	9.2	↖	2:	8.7	↗	3:	8.4	←	4:	10.8x	↘	5:	10.1	↗	6:	7.5	←	7:	10.6x	↑	8:	9.7	↗	9:	9.2	←	10:	9.8	↘	Series		89 (2x)			89 (2x)	<p>60 Shots</p>  <table border="1" style="width:100%; border-collapse: collapse;"> <tr><td>11:</td><td>9.3</td><td>↖</td></tr> <tr><td>12:</td><td>9.4</td><td>↖</td></tr> <tr><td>13:</td><td>6.9</td><td>→</td></tr> <tr><td>14:</td><td>9.1</td><td>←</td></tr> <tr><td>15:</td><td>8.7</td><td>←</td></tr> <tr><td>16:</td><td>7.6</td><td>↑</td></tr> <tr><td>17:</td><td>10.3</td><td>←</td></tr> <tr><td>18:</td><td>10.4x</td><td>↓</td></tr> <tr><td>19:</td><td>10.1</td><td>↖</td></tr> <tr><td>20:</td><td>10.6x</td><td>←</td></tr> <tr><td colspan="2">Series</td><td>88 (2x)</td></tr> <tr><td colspan="2"></td><td>177 (4x)</td></tr> </table>	11:	9.3	↖	12:	9.4	↖	13:	6.9	→	14:	9.1	←	15:	8.7	←	16:	7.6	↑	17:	10.3	←	18:	10.4x	↓	19:	10.1	↖	20:	10.6x	←	Series		88 (2x)			177 (4x)
1:	9.2	↖																																																																								
2:	8.7	↗																																																																								
3:	8.4	←																																																																								
4:	10.8x	↘																																																																								
5:	10.1	↗																																																																								
6:	7.5	←																																																																								
7:	10.6x	↑																																																																								
8:	9.7	↗																																																																								
9:	9.2	←																																																																								
10:	9.8	↘																																																																								
Series		89 (2x)																																																																								
		89 (2x)																																																																								
11:	9.3	↖																																																																								
12:	9.4	↖																																																																								
13:	6.9	→																																																																								
14:	9.1	←																																																																								
15:	8.7	←																																																																								
16:	7.6	↑																																																																								
17:	10.3	←																																																																								
18:	10.4x	↓																																																																								
19:	10.1	↖																																																																								
20:	10.6x	←																																																																								
Series		88 (2x)																																																																								
		177 (4x)																																																																								
<p>60 Shots</p> 	<table border="1" style="width:100%; border-collapse: collapse;"> <tr><td>21:</td><td>9.7</td><td>←</td></tr> <tr><td>22:</td><td>10.1</td><td>←</td></tr> <tr><td>23:</td><td>8.6</td><td>←</td></tr> <tr><td>24:</td><td>10.1</td><td>←</td></tr> <tr><td>25:</td><td>9.2</td><td>→</td></tr> <tr><td>26:</td><td>7.7</td><td>↗</td></tr> <tr><td>27:</td><td>10.0</td><td>↗</td></tr> <tr><td>28:</td><td>9.4</td><td>↗</td></tr> <tr><td>29:</td><td>8.5</td><td>←</td></tr> <tr><td>30:</td><td>9.8</td><td>↗</td></tr> <tr><td colspan="2">Series</td><td>89 (0x)</td></tr> <tr><td colspan="2"></td><td>266 (4x)</td></tr> </table>	21:	9.7	←	22:	10.1	←	23:	8.6	←	24:	10.1	←	25:	9.2	→	26:	7.7	↗	27:	10.0	↗	28:	9.4	↗	29:	8.5	←	30:	9.8	↗	Series		89 (0x)			266 (4x)	<p>60 Shots</p>  <table border="1" style="width:100%; border-collapse: collapse;"> <tr><td>31:</td><td>9.2</td><td>↑</td></tr> <tr><td>32:</td><td>9.8</td><td>↗</td></tr> <tr><td>33:</td><td>10.4x</td><td>←</td></tr> <tr><td>34:</td><td>7.9</td><td>↑</td></tr> <tr><td>35:</td><td>9.0</td><td>↑</td></tr> <tr><td>36:</td><td>10.1</td><td>↑</td></tr> <tr><td>37:</td><td>7.1</td><td>←</td></tr> <tr><td>38:</td><td>8.9</td><td>↖</td></tr> <tr><td>39:</td><td>10.3</td><td>↑</td></tr> <tr><td>40:</td><td>8.4</td><td>←</td></tr> <tr><td colspan="2">Series</td><td>87 (1x)</td></tr> <tr><td colspan="2"></td><td>353 (5x)</td></tr> </table>	31:	9.2	↑	32:	9.8	↗	33:	10.4x	←	34:	7.9	↑	35:	9.0	↑	36:	10.1	↑	37:	7.1	←	38:	8.9	↖	39:	10.3	↑	40:	8.4	←	Series		87 (1x)			353 (5x)
21:	9.7	←																																																																								
22:	10.1	←																																																																								
23:	8.6	←																																																																								
24:	10.1	←																																																																								
25:	9.2	→																																																																								
26:	7.7	↗																																																																								
27:	10.0	↗																																																																								
28:	9.4	↗																																																																								
29:	8.5	←																																																																								
30:	9.8	↗																																																																								
Series		89 (0x)																																																																								
		266 (4x)																																																																								
31:	9.2	↑																																																																								
32:	9.8	↗																																																																								
33:	10.4x	←																																																																								
34:	7.9	↑																																																																								
35:	9.0	↑																																																																								
36:	10.1	↑																																																																								
37:	7.1	←																																																																								
38:	8.9	↖																																																																								
39:	10.3	↑																																																																								
40:	8.4	←																																																																								
Series		87 (1x)																																																																								
		353 (5x)																																																																								
<p>60 Shots</p> 	<table border="1" style="width:100%; border-collapse: collapse;"> <tr><td>41:</td><td>8.7</td><td>←</td></tr> <tr><td>42:</td><td>10.6x</td><td>↗</td></tr> <tr><td>43:</td><td>9.7</td><td>↑</td></tr> <tr><td>44:</td><td>8.6</td><td>↗</td></tr> <tr><td>45:</td><td>9.2</td><td>↗</td></tr> <tr><td>46:</td><td>10.0</td><td>↑</td></tr> <tr><td>47:</td><td>9.5</td><td>→</td></tr> <tr><td>48:</td><td>9.8</td><td>↗</td></tr> <tr><td>49:</td><td>10.0</td><td>→</td></tr> <tr><td>50:</td><td>10.4x</td><td>↑</td></tr> <tr><td colspan="2">Series</td><td>92 (2x)</td></tr> <tr><td colspan="2"></td><td>445 (7x)</td></tr> </table>	41:	8.7	←	42:	10.6x	↗	43:	9.7	↑	44:	8.6	↗	45:	9.2	↗	46:	10.0	↑	47:	9.5	→	48:	9.8	↗	49:	10.0	→	50:	10.4x	↑	Series		92 (2x)			445 (7x)	<p>60 Shots</p>  <table border="1" style="width:100%; border-collapse: collapse;"> <tr><td>51:</td><td>10.9x</td><td>↗</td></tr> <tr><td>52:</td><td>9.8</td><td>↓</td></tr> <tr><td>53:</td><td>9.0</td><td>↓</td></tr> <tr><td>54:</td><td>10.4x</td><td>↗</td></tr> <tr><td>55:</td><td>9.2</td><td>↗</td></tr> <tr><td>56:</td><td>8.3</td><td>↖</td></tr> <tr><td>57:</td><td>9.3</td><td>↗</td></tr> <tr><td>58:</td><td>10.0</td><td>→</td></tr> <tr><td>59:</td><td>9.1</td><td>←</td></tr> <tr><td>60:</td><td>10.1</td><td>↖</td></tr> <tr><td colspan="2">Series</td><td>93 (2x)</td></tr> <tr><td colspan="2"></td><td>538 (9x)</td></tr> </table>	51:	10.9x	↗	52:	9.8	↓	53:	9.0	↓	54:	10.4x	↗	55:	9.2	↗	56:	8.3	↖	57:	9.3	↗	58:	10.0	→	59:	9.1	←	60:	10.1	↖	Series		93 (2x)			538 (9x)
41:	8.7	←																																																																								
42:	10.6x	↗																																																																								
43:	9.7	↑																																																																								
44:	8.6	↗																																																																								
45:	9.2	↗																																																																								
46:	10.0	↑																																																																								
47:	9.5	→																																																																								
48:	9.8	↗																																																																								
49:	10.0	→																																																																								
50:	10.4x	↑																																																																								
Series		92 (2x)																																																																								
		445 (7x)																																																																								
51:	10.9x	↗																																																																								
52:	9.8	↓																																																																								
53:	9.0	↓																																																																								
54:	10.4x	↗																																																																								
55:	9.2	↗																																																																								
56:	8.3	↖																																																																								
57:	9.3	↗																																																																								
58:	10.0	→																																																																								
59:	9.1	←																																																																								
60:	10.1	↖																																																																								
Series		93 (2x)																																																																								
		538 (9x)																																																																								

Sight	8	8	8																																																													
8	8	8	8																																																													
<table border="1" style="width:100%; border-collapse: collapse;"> <tr><td>1:</td><td>9.4</td><td>↑</td></tr> <tr><td>2:</td><td>10.8x</td><td>↑</td></tr> <tr><td>3:</td><td>9.6</td><td>→</td></tr> <tr><td>4:</td><td>9.1</td><td>→</td></tr> <tr><td>5:</td><td>9.2</td><td>↓</td></tr> <tr><td>6:</td><td>8.7</td><td>↓</td></tr> <tr><td>7:</td><td>9.8</td><td>←</td></tr> <tr><td>8:</td><td>9.4</td><td>→</td></tr> <tr><td>9:</td><td>10.4x</td><td>↑</td></tr> <tr><td>10:</td><td>10.1</td><td>→</td></tr> <tr><td colspan="2">Series</td><td>92 (2x)</td></tr> <tr><td colspan="2"></td><td>0 (0x)</td></tr> </table>	1:	9.4	↑	2:	10.8x	↑	3:	9.6	→	4:	9.1	→	5:	9.2	↓	6:	8.7	↓	7:	9.8	←	8:	9.4	→	9:	10.4x	↑	10:	10.1	→	Series		92 (2x)			0 (0x)	Sight	8	8																									
1:	9.4	↑																																																														
2:	10.8x	↑																																																														
3:	9.6	→																																																														
4:	9.1	→																																																														
5:	9.2	↓																																																														
6:	8.7	↓																																																														
7:	9.8	←																																																														
8:	9.4	→																																																														
9:	10.4x	↑																																																														
10:	10.1	→																																																														
Series		92 (2x)																																																														
		0 (0x)																																																														
8	8	8	8																																																													
<table border="1" style="width:100%; border-collapse: collapse;"> <tr><td>11:</td><td>10.8x</td><td>↙</td></tr> <tr><td>12:</td><td>10.2</td><td>↘</td></tr> <tr><td>13:</td><td>9.6</td><td>→</td></tr> <tr><td>14:</td><td>10.5x</td><td>↘</td></tr> <tr><td>15:</td><td>9.0</td><td>→</td></tr> <tr><td>16:</td><td>9.8</td><td>←</td></tr> <tr><td colspan="2">Series</td><td>57 (2x)</td></tr> <tr><td colspan="2"></td><td>0 (0x)</td></tr> </table>	11:	10.8x	↙	12:	10.2	↘	13:	9.6	→	14:	10.5x	↘	15:	9.0	→	16:	9.8	←	Series		57 (2x)			0 (0x)	<table border="1" style="width:100%; border-collapse: collapse;"> <tr><td>1:</td><td>9.9</td><td>↑</td></tr> <tr><td>2:</td><td>10.2</td><td>↑</td></tr> <tr><td>3:</td><td>8.7</td><td>↓</td></tr> <tr><td>4:</td><td>9.5</td><td>←</td></tr> <tr><td>5:</td><td>10.4x</td><td>↑</td></tr> <tr><td>6:</td><td>9.9</td><td>↓</td></tr> <tr><td>7:</td><td>9.4</td><td>→</td></tr> <tr><td>8:</td><td>10.2</td><td>→</td></tr> <tr><td>9:</td><td>10.1</td><td>↓</td></tr> <tr><td>10:</td><td>10.5x</td><td>→</td></tr> <tr><td colspan="2">Series</td><td>94 (2x)</td></tr> <tr><td colspan="2"></td><td>94 (2x)</td></tr> </table>	1:	9.9	↑	2:	10.2	↑	3:	8.7	↓	4:	9.5	←	5:	10.4x	↑	6:	9.9	↓	7:	9.4	→	8:	10.2	→	9:	10.1	↓	10:	10.5x	→	Series		94 (2x)			94 (2x)	Sight	8	8
11:	10.8x	↙																																																														
12:	10.2	↘																																																														
13:	9.6	→																																																														
14:	10.5x	↘																																																														
15:	9.0	→																																																														
16:	9.8	←																																																														
Series		57 (2x)																																																														
		0 (0x)																																																														
1:	9.9	↑																																																														
2:	10.2	↑																																																														
3:	8.7	↓																																																														
4:	9.5	←																																																														
5:	10.4x	↑																																																														
6:	9.9	↓																																																														
7:	9.4	→																																																														
8:	10.2	→																																																														
9:	10.1	↓																																																														
10:	10.5x	→																																																														
Series		94 (2x)																																																														
		94 (2x)																																																														
8	8	8	8																																																													
<table border="1" style="width:100%; border-collapse: collapse;"> <tr><td>11:</td><td>10.0</td><td>→</td></tr> <tr><td>12:</td><td>9.6</td><td>↗</td></tr> <tr><td>13:</td><td>10.0</td><td>↗</td></tr> <tr><td>14:</td><td>9.9</td><td>←</td></tr> <tr><td>15:</td><td>9.8</td><td>↓</td></tr> <tr><td>16:</td><td>10.1</td><td>→</td></tr> <tr><td>17:</td><td>10.1</td><td>←</td></tr> <tr><td>18:</td><td>9.8</td><td>←</td></tr> <tr><td>19:</td><td>10.0</td><td>↖</td></tr> <tr><td>20:</td><td>10.3</td><td>↘</td></tr> <tr><td colspan="2">Series</td><td>96 (0x)</td></tr> <tr><td colspan="2"></td><td>190 (2x)</td></tr> </table>	11:	10.0	→	12:	9.6	↗	13:	10.0	↗	14:	9.9	←	15:	9.8	↓	16:	10.1	→	17:	10.1	←	18:	9.8	←	19:	10.0	↖	20:	10.3	↘	Series		96 (0x)			190 (2x)	60 Shots	8	8																									
11:	10.0	→																																																														
12:	9.6	↗																																																														
13:	10.0	↗																																																														
14:	9.9	←																																																														
15:	9.8	↓																																																														
16:	10.1	→																																																														
17:	10.1	←																																																														
18:	9.8	←																																																														
19:	10.0	↖																																																														
20:	10.3	↘																																																														
Series		96 (0x)																																																														
		190 (2x)																																																														
8	8	8	8																																																													
<table border="1" style="width:100%; border-collapse: collapse;"> <tr><td>21:</td><td>10.4x</td><td>←</td></tr> <tr><td>22:</td><td>9.8</td><td>←</td></tr> <tr><td>23:</td><td>9.2</td><td>↓</td></tr> <tr><td>24:</td><td>9.3</td><td>↗</td></tr> <tr><td>25:</td><td>10.9x</td><td>↑</td></tr> <tr><td>26:</td><td>10.1</td><td>↘</td></tr> <tr><td>27:</td><td>10.0</td><td>←</td></tr> <tr><td>28:</td><td>9.3</td><td>↓</td></tr> <tr><td>29:</td><td>10.1</td><td>↓</td></tr> <tr><td>30:</td><td>10.7x</td><td>↑</td></tr> <tr><td colspan="2">Series</td><td>96 (3x)</td></tr> <tr><td colspan="2"></td><td>286 (5x)</td></tr> </table>	21:	10.4x	←	22:	9.8	←	23:	9.2	↓	24:	9.3	↗	25:	10.9x	↑	26:	10.1	↘	27:	10.0	←	28:	9.3	↓	29:	10.1	↓	30:	10.7x	↑	Series		96 (3x)			286 (5x)	60 Shots	8	8																									
21:	10.4x	←																																																														
22:	9.8	←																																																														
23:	9.2	↓																																																														
24:	9.3	↗																																																														
25:	10.9x	↑																																																														
26:	10.1	↘																																																														
27:	10.0	←																																																														
28:	9.3	↓																																																														
29:	10.1	↓																																																														
30:	10.7x	↑																																																														
Series		96 (3x)																																																														
		286 (5x)																																																														
8	8	8	8																																																													
<table border="1" style="width:100%; border-collapse: collapse;"> <tr><td>31:</td><td>9.5</td><td>↗</td></tr> <tr><td>32:</td><td>9.8</td><td>↑</td></tr> <tr><td>33:</td><td>8.7</td><td>←</td></tr> <tr><td>34:</td><td>10.2</td><td>←</td></tr> <tr><td>35:</td><td>10.2</td><td>←</td></tr> <tr><td>36:</td><td>9.0</td><td>↘</td></tr> <tr><td>37:</td><td>9.6</td><td>←</td></tr> <tr><td>38:</td><td>10.8x</td><td>→</td></tr> <tr><td>39:</td><td>10.9x</td><td>↘</td></tr> <tr><td>40:</td><td>9.6</td><td>↓</td></tr> <tr><td colspan="2">Series</td><td>93 (2x)</td></tr> <tr><td colspan="2"></td><td>379 (7x)</td></tr> </table>	31:	9.5	↗	32:	9.8	↑	33:	8.7	←	34:	10.2	←	35:	10.2	←	36:	9.0	↘	37:	9.6	←	38:	10.8x	→	39:	10.9x	↘	40:	9.6	↓	Series		93 (2x)			379 (7x)	60 Shots	8	8																									
31:	9.5	↗																																																														
32:	9.8	↑																																																														
33:	8.7	←																																																														
34:	10.2	←																																																														
35:	10.2	←																																																														
36:	9.0	↘																																																														
37:	9.6	←																																																														
38:	10.8x	→																																																														
39:	10.9x	↘																																																														
40:	9.6	↓																																																														
Series		93 (2x)																																																														
		379 (7x)																																																														
8	8	8	8																																																													
<table border="1" style="width:100%; border-collapse: collapse;"> <tr><td>41:</td><td>9.7</td><td>→</td></tr> <tr><td>42:</td><td>9.2</td><td>←</td></tr> <tr><td>43:</td><td>10.1</td><td>←</td></tr> <tr><td>44:</td><td>9.9</td><td>↗</td></tr> <tr><td>45:</td><td>9.7</td><td>←</td></tr> <tr><td>46:</td><td>10.4x</td><td>←</td></tr> <tr><td>47:</td><td>10.5x</td><td>↖</td></tr> <tr><td>48:</td><td>8.4</td><td>↓</td></tr> <tr><td>49:</td><td>8.6</td><td>←</td></tr> <tr><td>50:</td><td>9.4</td><td>←</td></tr> <tr><td colspan="2">Series</td><td>91 (2x)</td></tr> <tr><td colspan="2"></td><td>470 (9x)</td></tr> </table>	41:	9.7	→	42:	9.2	←	43:	10.1	←	44:	9.9	↗	45:	9.7	←	46:	10.4x	←	47:	10.5x	↖	48:	8.4	↓	49:	8.6	←	50:	9.4	←	Series		91 (2x)			470 (9x)	60 Shots	8	8																									
41:	9.7	→																																																														
42:	9.2	←																																																														
43:	10.1	←																																																														
44:	9.9	↗																																																														
45:	9.7	←																																																														
46:	10.4x	←																																																														
47:	10.5x	↖																																																														
48:	8.4	↓																																																														
49:	8.6	←																																																														
50:	9.4	←																																																														
Series		91 (2x)																																																														
		470 (9x)																																																														
8	8	8	8																																																													
<table border="1" style="width:100%; border-collapse: collapse;"> <tr><td>51:</td><td>9.0</td><td>↑</td></tr> <tr><td>52:</td><td>9.1</td><td>↖</td></tr> <tr><td>53:</td><td>9.7</td><td>↓</td></tr> <tr><td>54:</td><td>10.7x</td><td>↘</td></tr> <tr><td>55:</td><td>10.7x</td><td>↓</td></tr> <tr><td>56:</td><td>10.1</td><td>↓</td></tr> <tr><td>57:</td><td>8.3</td><td>←</td></tr> <tr><td>58:</td><td>8.9</td><td>←</td></tr> <tr><td>59:</td><td>8.9</td><td>↘</td></tr> <tr><td>60:</td><td>9.1</td><td>↘</td></tr> <tr><td colspan="2">Series</td><td>90 (2x)</td></tr> <tr><td colspan="2"></td><td>560 (11x)</td></tr> </table>	51:	9.0	↑	52:	9.1	↖	53:	9.7	↓	54:	10.7x	↘	55:	10.7x	↓	56:	10.1	↓	57:	8.3	←	58:	8.9	←	59:	8.9	↘	60:	9.1	↘	Series		90 (2x)			560 (11x)																												
51:	9.0	↑																																																														
52:	9.1	↖																																																														
53:	9.7	↓																																																														
54:	10.7x	↘																																																														
55:	10.7x	↓																																																														
56:	10.1	↓																																																														
57:	8.3	←																																																														
58:	8.9	←																																																														
59:	8.9	↘																																																														
60:	9.1	↘																																																														
Series		90 (2x)																																																														
		560 (11x)																																																														

Comment	Signature
---------	-----------

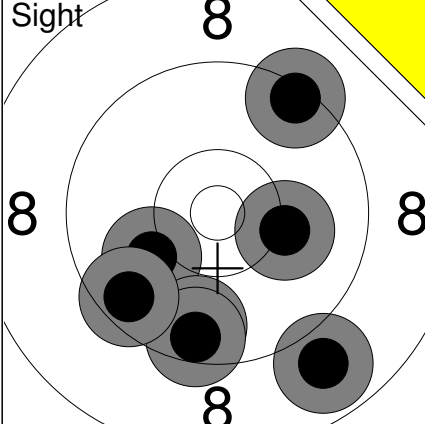
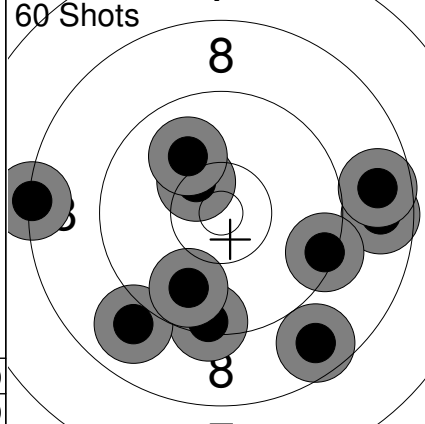
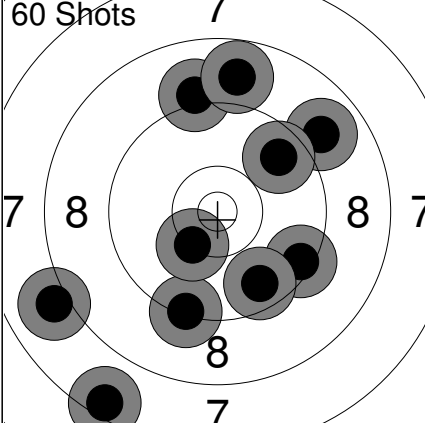
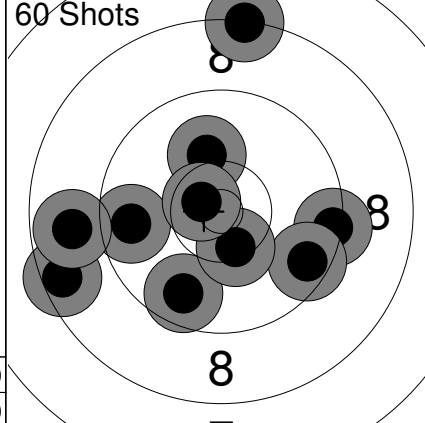
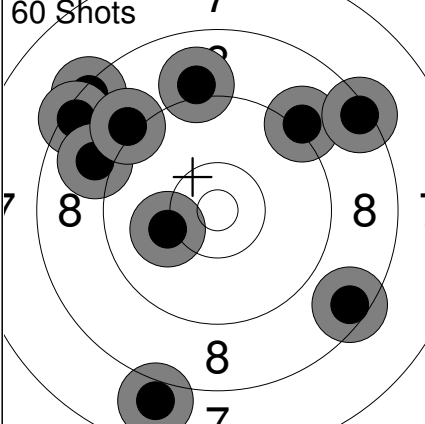
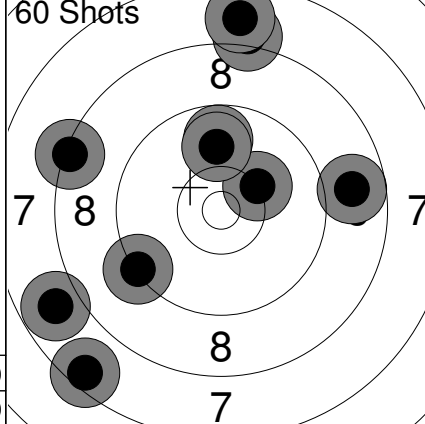
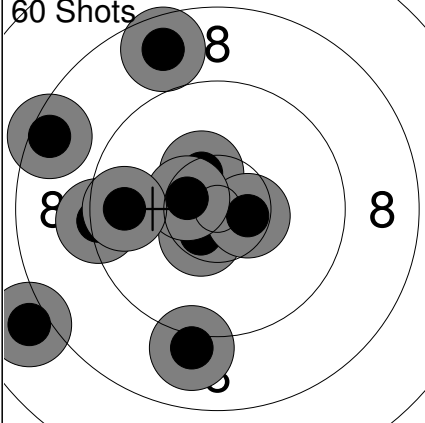
<p>Sight</p> 	<p>1: 10.1 ↙ 2: 9.7 ↓ 3: 9.4 ↗ 4: 8.9 ↓ 5: 9.5 ↓ 6: 9.6 ↙ 7: 10.2 →</p>	<p>60 Shots</p> 	<p>1: 8.7 ↓ 2: 8.7 → 3: 9.4 ↓ 4: 9.0 ↙ 5: 9.8 ↓ 6: 9.4 → 7: 10.4x ↗ 8: 8.7 → 9: 8.3 ← 10: 10.0 ↗</p>
<p>Series 64 (0x) 0 (0x)</p>		<p>Series 88 (1x) 88 (1x)</p>	
<p>60 Shots</p> 	<p>11: 8.9 ↗ 12: 7.5 ↓ 13: 9.1 ↗ 14: 9.3 ↓ 15: 8.8 ↗ 16: 9.4 → 17: 8.0 ↙ 18: 9.7 ↗ 19: 9.6 ↓ 20: 10.3 ↓</p>	<p>60 Shots</p> 	<p>21: 9.7 ← 22: 9.4 → 23: 9.5 ↗ 24: 10.1 ↗ 25: 8.5 ← 26: 9.7 ↓ 27: 8.3 ↗ 28: 10.4x ↓ 29: 10.6x ↙ 30: 8.8 ←</p>
<p>Series 86 (0x) 174 (1x)</p>		<p>Series 90 (2x) 264 (3x)</p>	
<p>60 Shots</p> 	<p>31: 9.1 ↗ 32: 8.3 ↗ 33: 8.4 ↗ 34: 9.0 ↗ 35: 10.1 ← 36: 7.9 ↓ 37: 8.4 ↗ 38: 9.0 ↗ 39: 9.1 ↗ 40: 8.5 ↓</p>	<p>60 Shots</p> 	<p>41: 10.2 ↗ 42: 8.8 → 43: 8.3 ← 44: 8.1 ↗ 45: 7.8 ↙ 46: 9.3 ↙ 47: 7.8 ↗ 48: 7.5 ↙ 49: 9.8 ↗ 50: 9.9 ↗</p>
<p>Series 85 (0x) 349 (3x)</p>		<p>Series 82 (0x) 431 (3x)</p>	
<p>60 Shots</p> 	<p>51: 9.0 ↓ 52: 10.5x ↓ 53: 10.4x ↗ 54: 8.7 ↗ 55: 10.5x → 56: 9.3 ← 57: 8.0 ← 58: 10.5x ← 59: 9.7 ← 60: 8.5 ↙</p>		
<p>Series 91 (4x) 522 (7x)</p>			

Relay <b>2</b>	Lane <b>19</b>	<b>VASILEVA Yanka</b>
-------------------	-------------------	-----------------------

2023 SFC Pistol Nationals	QC	MA	WP
---------------------------	----	----	----

15.07.2023	PN23AP-Q-1	Alberta Handgun Association
------------	------------	-----------------------------

Comment	Signature
---------	-----------

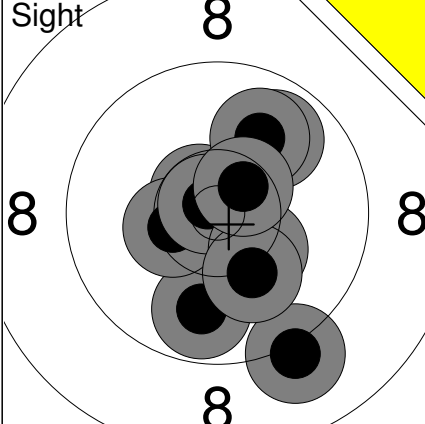
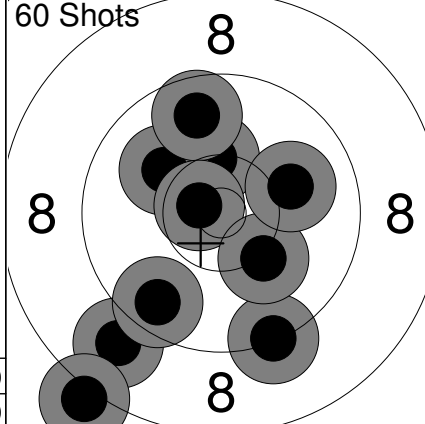
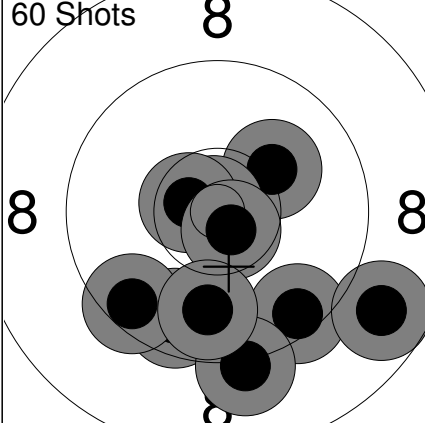
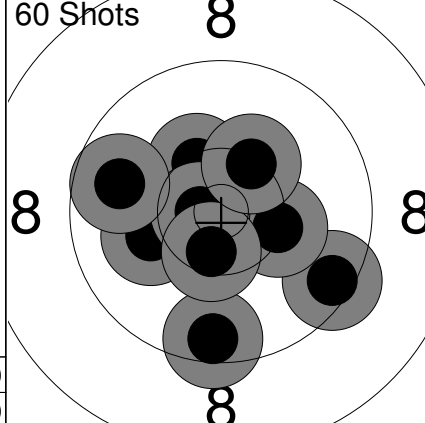
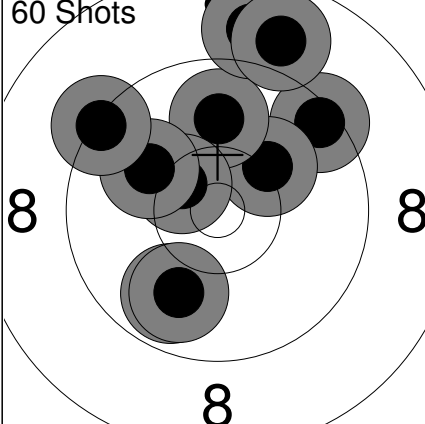
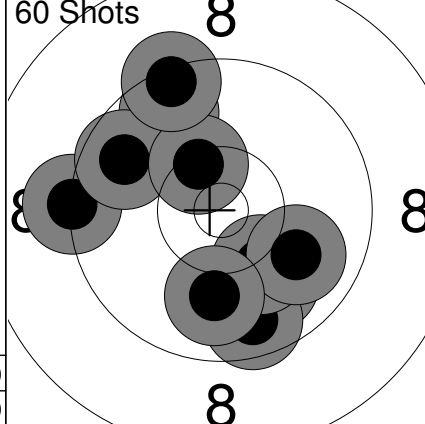
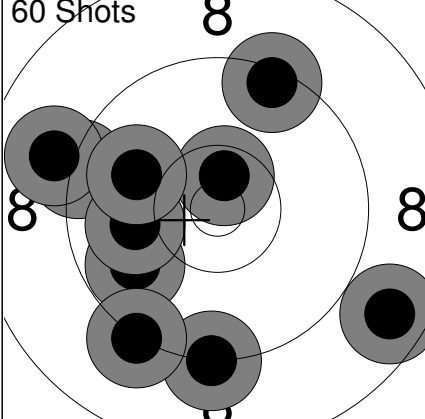
<p>Sight</p> 	<p>1: 10.6x ↗ 2: 9.9 ↗ 3: 9.8 ↓ 4: 10.4x ← 5: 9.1 ↓ 6: 10.0 ↗ 7: 10.8x ↗ 8: 10.3 ↓ 9: 10.2 ↓ 10: 10.5x ↗</p> <p>Series 97 (4x) 0 (0x)</p>	<p>60 Shots</p> 	<p>1: 10.3 ↑ 2: 9.3 ↓ 3: 10.1 ↗ 4: 9.7 ↗ 5: 10.7x ← 6: 8.9 ↓ 7: 8.1 ↓ 8: 10.2 ↓ 9: 10.0 → 10: 9.6 ↓</p> <p>Series 93 (1x) 93 (1x)</p>
<p>60 Shots</p> 	<p>11: 10.2 ↗ 12: 9.6 ↓ 13: 9.5 ↓ 14: 9.5 ← 15: 9.2 ↓ 16: 10.9x ↗ 17: 10.6x ↗ 18: 10.7x ↓ 19: 9.8 ↓ 20: 8.8 ↓</p> <p>Series 93 (3x) 186 (4x)</p>	<p>60 Shots</p> 	<p>21: 10.2 ← 22: 9.5 ↘ 23: 10.3 → 24: 9.5 ↓ 25: 10.1 ← 26: 10.3 ↗ 27: 10.7x ← 28: 10.5x ↓ 29: 10.3 ↗ 30: 9.8 ←</p> <p>Series 97 (2x) 283 (6x)</p>
<p>60 Shots</p> 	<p>31: 9.4 ↗ 32: 9.9 ↓ 33: 10.2 ↗ 34: 9.9 ↗ 35: 10.5x ↗ 36: 10.0 ↗ 37: 9.9 ↓ 38: 9.3 ↗ 39: 8.8 ↗ 40: 8.9 ↗</p> <p>Series 91 (1x) 374 (7x)</p>	<p>60 Shots</p> 	<p>41: 10.0 ↓ 42: 9.7 ↗ 43: 9.7 ↓ 44: 10.2 ↓ 45: 10.0 ↓ 46: 9.3 ← 47: 9.7 ↗ 48: 10.0 ↓ 49: 10.4x ↗ 50: 9.4 ↗</p> <p>Series 95 (1x) 469 (8x)</p>
<p>60 Shots</p> 	<p>51: 9.2 ↓ 52: 9.3 ← 53: 8.7 ↘ 54: 9.8 ← 55: 9.0 ← 56: 9.2 ↓ 57: 10.0 ← 58: 10.6x ↑ 59: 9.4 ↗ 60: 10.0 ←</p> <p>Series 92 (1x) 561 (9x)</p>		



Relay <b>2</b>	Lane <b>20</b>	<b>LI Ethan</b>
-------------------	-------------------	-----------------

2023 SFC Pistol Nationals	IJ	MP
---------------------------	----	----

15.07.2023	PN23AP-Q-1	Alberta Handgun Association
------------	------------	-----------------------------

Comment	Signature
---------	-----------

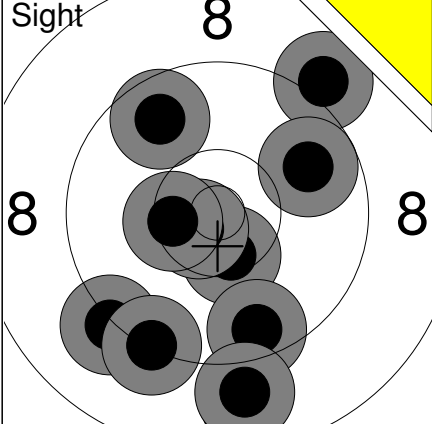
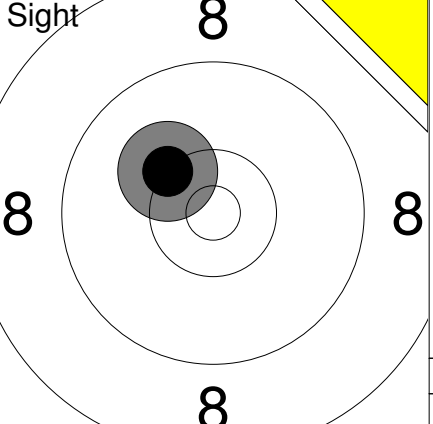
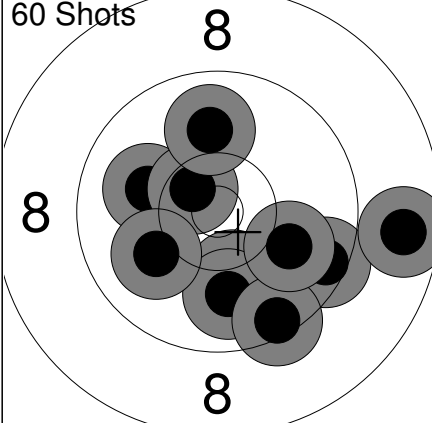
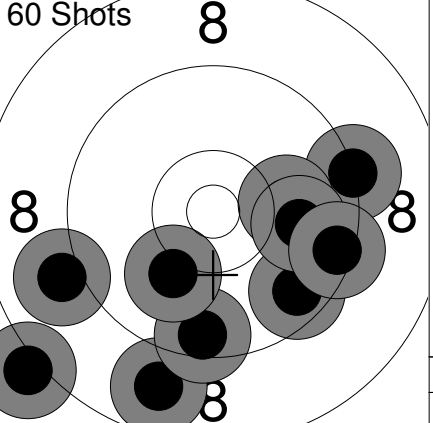
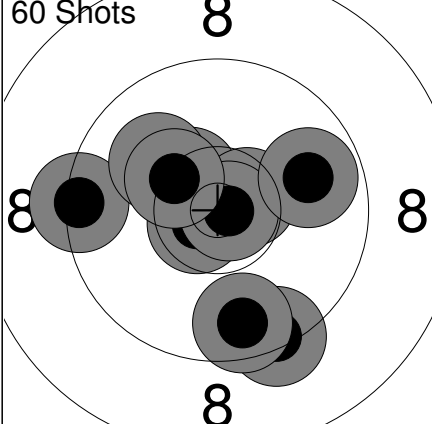
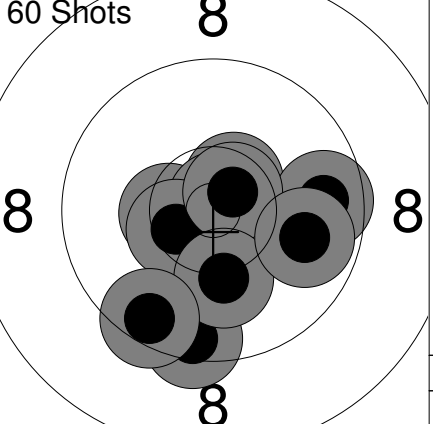
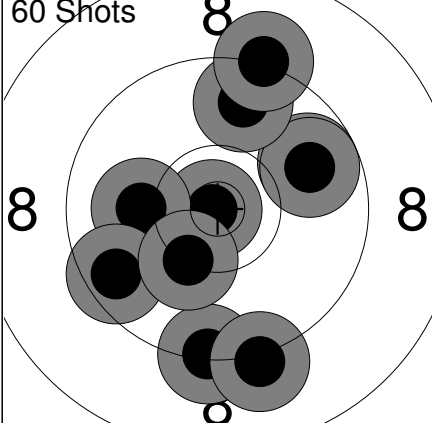
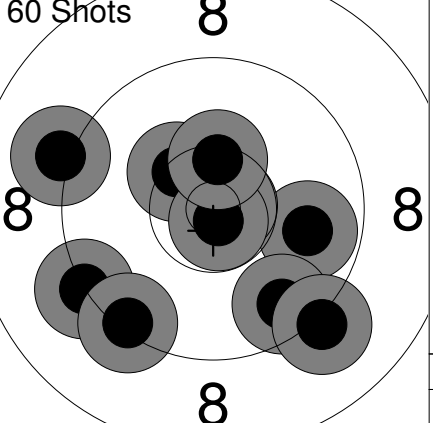
<p>Sight</p> 	<p>1: 9.2 ↙ 2: 9.0 ↗ 3: 10.4x ↓ 4: 9.8 → 5: 10.7x ↙ 6: 9.7 ↗ 7: 9.6 ↓ 8: 9.3 ↓ 9: 8.9 ↓ 10: 10.4x ←</p> <p>Series 92 (3x) 0 (0x)</p>	<p>Sight</p> 	<p>11: 10.3 ↗</p> <p>Series 10 (0x) 0 (0x)</p>
<p>60 Shots</p> 	<p>1: 10.2 ↓ 2: 10.1 ↗ 3: 9.9 ↓ 4: 10.5x ↗ 5: 10.0 ↙ 6: 9.5 ↓ 7: 9.9 ↗ 8: 9.4 ↓ 9: 10.0 ↓ 10: 8.7 →</p> <p>Series 94 (1x) 94 (1x)</p>	<p>60 Shots</p> 	<p>11: 8.8 ↓ 12: 9.6 ↘ 13: 9.0 ← 14: 9.2 → 15: 9.5 ↓ 16: 10.1 → 17: 9.9 → 18: 10.1 ↓ 19: 9.4 → 20: 8.1 ↙</p> <p>Series 90 (0x) 184 (1x)</p>
<p>60 Shots</p> 	<p>21: 10.5x ↗ 22: 10.7x ↙ 23: 9.4 ↓ 24: 10.6x → 25: 9.4 ← 26: 9.6 ↓ 27: 10.8x → 28: 10.1 ↗ 29: 9.9 → 30: 10.3 ↗</p> <p>Series 96 (4x) 280 (5x)</p>	<p>60 Shots</p> 	<p>31: 10.4x ← 32: 10.6x ↗ 33: 10.8x ↗ 34: 9.7 → 35: 10.5x ↙ 36: 10.6x ↗ 37: 9.5 ↓ 38: 10.2 ↓ 39: 9.5 ↓ 40: 9.9 →</p> <p>Series 96 (5x) 376 (10x)</p>
<p>60 Shots</p> 	<p>41: 9.8 → 42: 9.8 → 43: 10.9x ← 44: 9.3 ↓ 45: 9.1 ↓ 46: 10.1 ← 47: 9.6 ↙ 48: 10.3 ↓ 49: 9.7 ↗ 50: 9.2 ↗</p> <p>Series 93 (1x) 469 (11x)</p>	<p>60 Shots</p> 	<p>51: 9.8 → 52: 10.8x → 53: 9.6 ↓ 54: 10.4x ↗ 55: 10.8x ↓ 56: 9.2 ↙ 57: 9.1 ↙ 58: 9.3 ↓ 59: 10.4x ↗ 60: 9.1 ↓</p> <p>Series 94 (4x) 563 (15x)</p>

Comment	Signature
---------	-----------

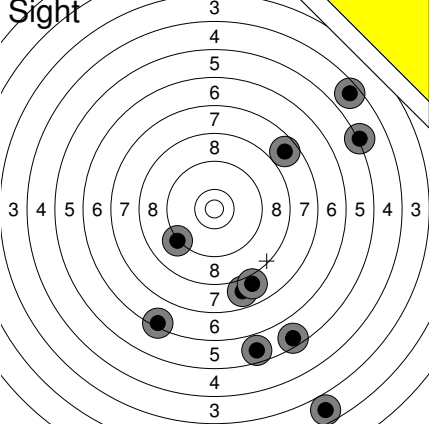
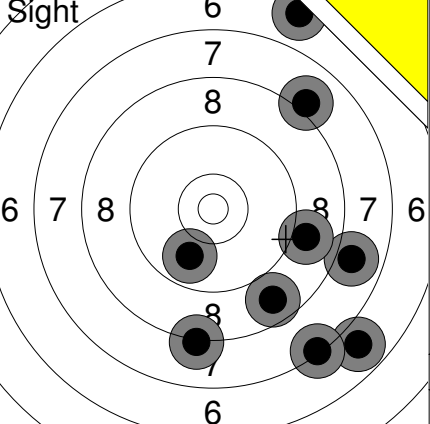
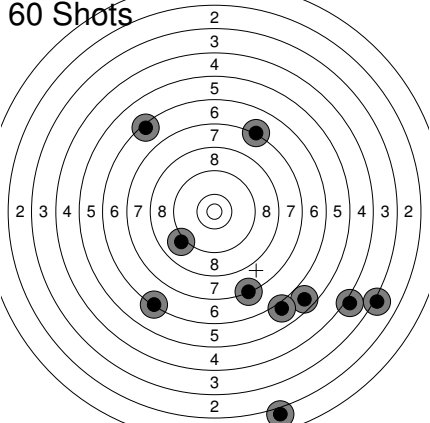
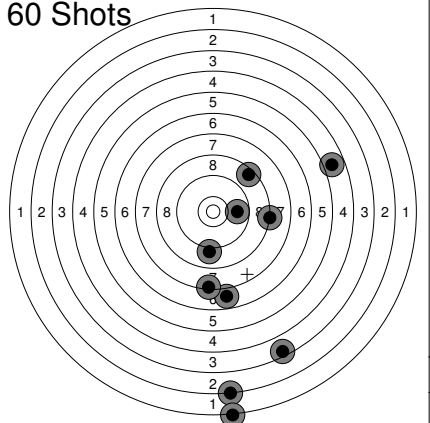
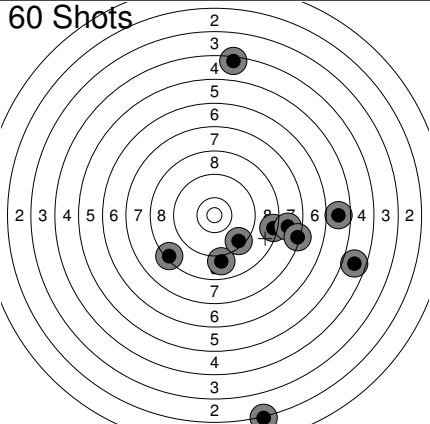
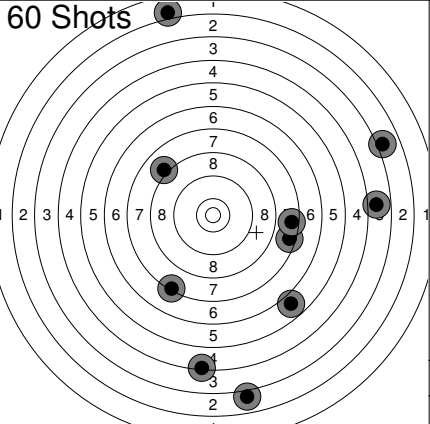
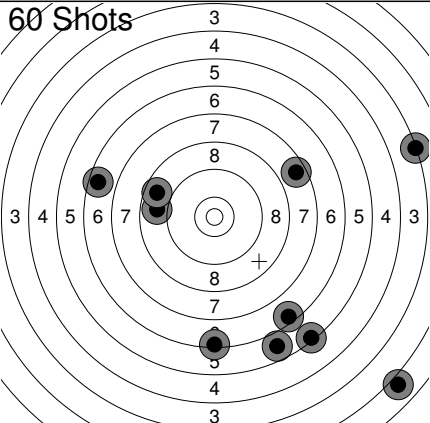
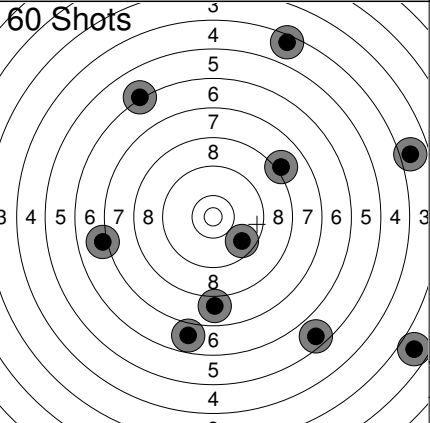
<p><b>Sight</b></p> 	<p>1: 7.7 ↗ 2: 7.8 ↓ 3: 6.4 ↓ 4: 9.2 ← 5: 5.1 → 6: 2.7 ↓ 7: 7.9 ↓ 8: 5.5 ↓ 9: 5.7 ↓ 10: 4.6 ↗</p> <p>Series 57 (0x) 0 (0x)</p>	<p><b>Sight</b></p> 	<p>11: 9.9 ↓ 12: 8.2 ↓ 13: 7.9 → 14: 6.8 ↓ 15: 6.5 ↑ 16: 8.0 ↗ 17: 7.3 ↓ 18: 8.7 ↓ 19: 8.9 →</p> <p>Series 67 (0x) 0 (0x)</p>
<p><b>60 Shots</b></p> 	<p>1: 7.2 ↗ 2: 9.0 ← 3: 3.1 ↓ 4: 2.0 ↓ 5: 6.2 ↓ 6: 7.3 ↓ 7: 4.0 ↓ 8: 6.4 ↗ 9: 5.6 ↓ 10: 6.0 ↓</p> <p>Series 55 (0x) 55 (0x)</p>	<p><b>60 Shots</b></p> 	<p>11: 9.0 ↓ 12: 9.8 → 13: 6.8 ↓ 14: 3.5 ↓ 15: 4.8 → 16: 8.2 → 17: 2.2 ↓ 18: 1.2 ↓ 19: 7.3 ↓ 20: 8.5 ↗</p> <p>Series 57 (0x) 112 (0x)</p>
<p><b>60 Shots</b></p> 	<p>21: 8.4 → 22: 9.0 ↓ 23: 5.7 → 24: 4.4 ↑ 25: 8.4 ← 26: 7.8 → 27: 2.2 ↓ 28: 4.7 → 29: 9.5 ↓ 30: 7.3 →</p> <p>Series 63 (0x) 175 (0x)</p>	<p><b>60 Shots</b></p> 	<p>31: 5.8 ↓ 32: 7.5 → 33: 4.3 ↓ 34: 3.0 ↓ 35: 7.3 ↓ 36: 7.5 → 37: 3.0 → 38: 8.1 ↗ 39: 3.8 → 40: 2.0 ↑</p> <p>Series 49 (0x) 224 (0x)</p>
<p><b>60 Shots</b></p> 	<p>41: 5.4 ↓ 42: 6.5 ↓ 43: 1.9 ↓ 44: 8.9 ← 45: 7.6 → 46: 6.6 ↗ 47: 3.3 → 48: 8.7 ↗ 49: 5.8 ↓ 50: 6.3 ↓</p> <p>Series 55 (0x) 279 (0x)</p>	<p><b>60 Shots</b></p> 	<p>51: 8.1 ↗ 52: 6.8 ↓ 53: 6.2 ↗ 54: 3.9 → 55: 2.7 ↓ 56: 7.9 ↓ 57: 5.6 ↓ 58: 7.1 ← 59: 9.7 ↓ 60: 4.5 ↑</p> <p>Series 57 (0x) 336 (0x)</p>

Relay **2** Lane **22** **WANG Eddie shihan**

2023 SFC Pistol Nationals BC SJ MP

15.07.2023 PN23AP-Q-1 Alberta Handgun Association

Comment Signature

	1: 9.6 ↗ 2: 9.8 ↘ 3: 10.4x ↗ 4: 9.4 ↗ 5: 9.1 ↗ 6: 8.5 ↑		1: 9.4 ↗ 2: 9.7 → 3: 9.0 ↗ 4: 9.6 ↘ 5: 9.5 ↘ 6: 9.7 ↗ 7: 9.8 ↓ 8: 9.1 → 9: 9.6 → 10: 10.2 ↙
	Series 54 (1x) 0 (0x)		Series 91 (0x) 91 (0x)

	11: 7.8 → 12: 8.9 ↘ 13: 8.7 ↗ 14: 7.5 ↑ 15: 9.6 ↘ 16: 9.8 ↙ 17: 7.6 → 18: 8.9 ↘ 19: 8.8 → 20: 10.5x ↙		21: 9.3 ↗ 22: 10.5x ↑ 23: 10.3 ↗ 24: 8.7 ↘ 25: 8.9 ↑ 26: 9.7 ↑ 27: 7.9 ↑ 28: 8.4 ↗ 29: 9.5 → 30: 10.1 ↑
	Series 81 (1x) 172 (1x)		Series 88 (1x) 260 (2x)

	31: 8.7 ↘ 32: 7.3 → 33: 8.7 ↑ 34: 9.1 ↙ 35: 9.8 ↘ 36: 9.4 ↗ 37: 7.4 ↘ 38: 7.9 ↘ 39: 9.2 → 40: 10.4x ↗		41: 8.8 ↘ 42: 8.0 ↗ 43: 8.2 → 44: 5.5 ↘ 45: 8.5 → 46: 9.5 ↗ 47: 8.0 → 48: 8.1 ↗ 49: 8.9 → 50: 10.1 ↙
	Series 83 (1x) 343 (3x)		Series 80 (0x) 423 (3x)

	51: 8.5 → 52: 8.6 → 53: 9.0 → 54: 8.5 → 55: 9.4 ↗ 56: 8.4 ↑ 57: 9.4 → 58: 8.9 ↘ 59: 8.1 ↘ 60: 10.8x →		
	Series 85 (1x) 508 (4x)		

Relay **2** Lane **23** **PADDA Harvir singh**

2023 SFC Pistol Nationals BC SJ MP

15.07.2023 PN23AP-Q-1 Alberta Handgun Association

Comment Signature

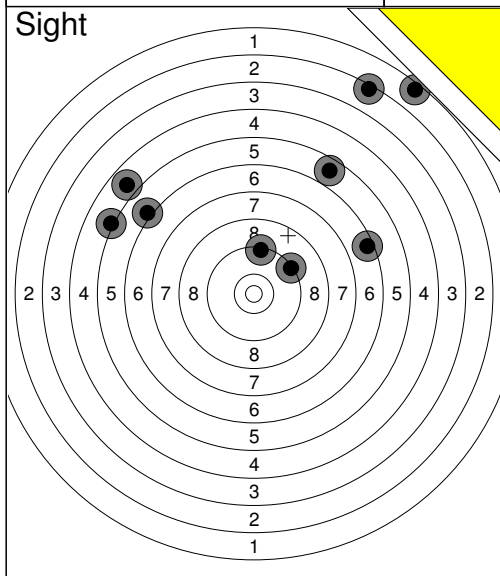

1:	2.4	↗
2:	5.2	↖
3:	9.3	↑
4:	9.3	↗
5:	0.0	↓
6:	6.1	↗
7:	5.7	↗
8:	4.8	↖
9:	1.5	↗
10:	6.5	→
Series	47 (0x)	
	0 (0x)	

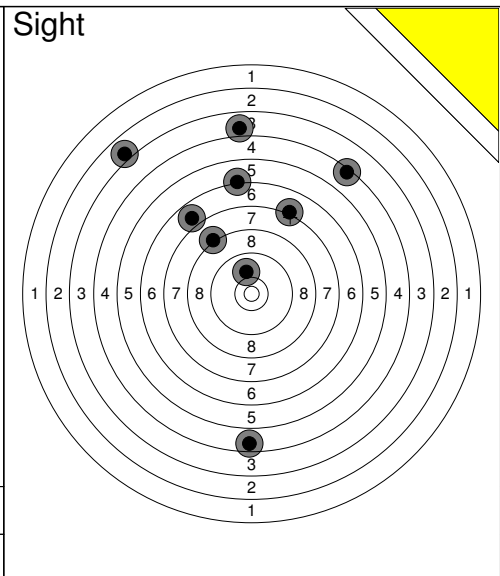

11:	10.0	↑
12:	3.9	↑
13:	8.1	↖
14:	7.1	↗
15:	4.4	↗
16:	6.9	↖
17:	6.2	↑
18:	0.0	→
19:	2.9	↖
20:	4.6	↓
Series	50 (0x)	
	0 (0x)	

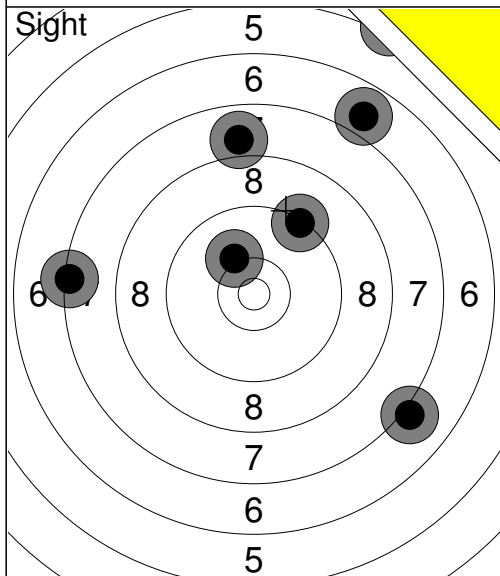

21:	6.9	↗
22:	5.1	↗
23:	7.3	←
24:	7.9	↑
25:	9.3	↗
26:	10.2	↗
27:	7.1	↓
Series	51 (0x)	
	0 (0x)	

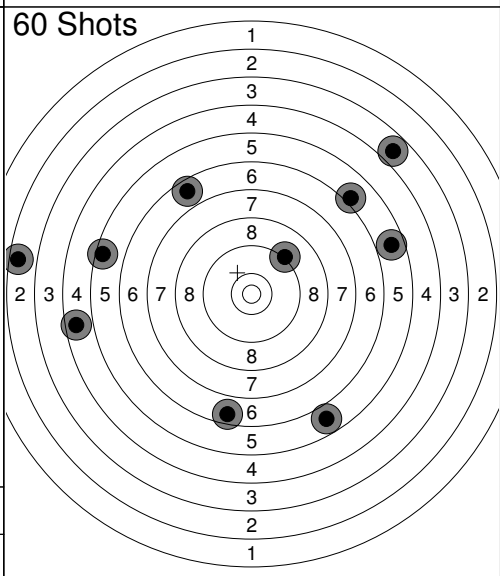

1:	6.6	↖
2:	5.5	←
3:	6.6	↓
4:	5.7	→
5:	5.8	↓
6:	3.8	↗
7:	6.0	↗
8:	4.6	←
9:	2.5	←
10:	9.2	↗
Series	51 (0x)	
	51 (0x)	

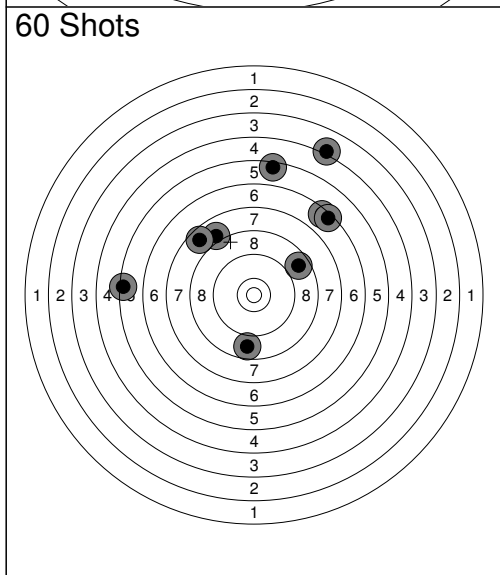

11:	8.7	↗
12:	0.0	←
13:	5.4	←
14:	8.0	↖
15:	6.4	↗
16:	4.1	↗
17:	8.7	↓
18:	5.5	↑
19:	6.4	↗
20:	7.6	↖
Series	57 (0x)	
	108 (0x)	

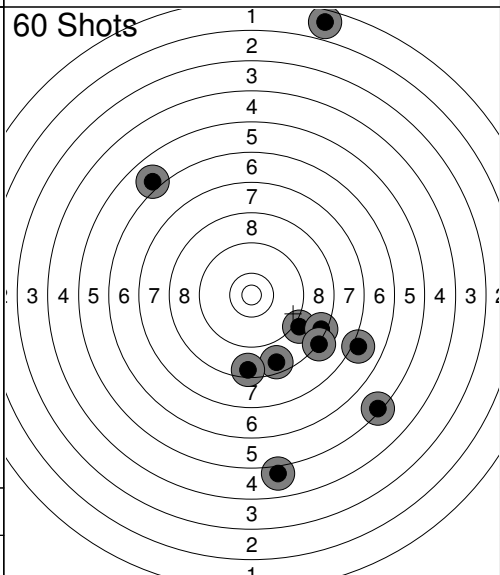

21:	9.1	↘
22:	1.6	↑
23:	8.6	↓
24:	6.0	↗
25:	8.5	↓
26:	8.4	↘
27:	8.2	↘
28:	7.0	↘
29:	5.4	↘
30:	5.0	↓
Series	65 (0x)	
	173 (0x)	

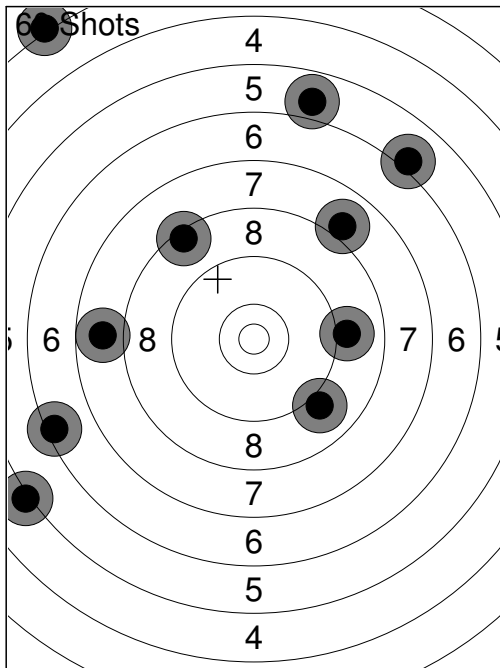

31:	8.4	↖
32:	6.4	←
33:	9.0	→
34:	8.0	↗
35:	7.8	←
36:	6.0	↗
37:	5.9	↑
38:	5.2	←
39:	9.0	↘
40:	3.2	↖
Series	66 (0x)	
	239 (0x)	

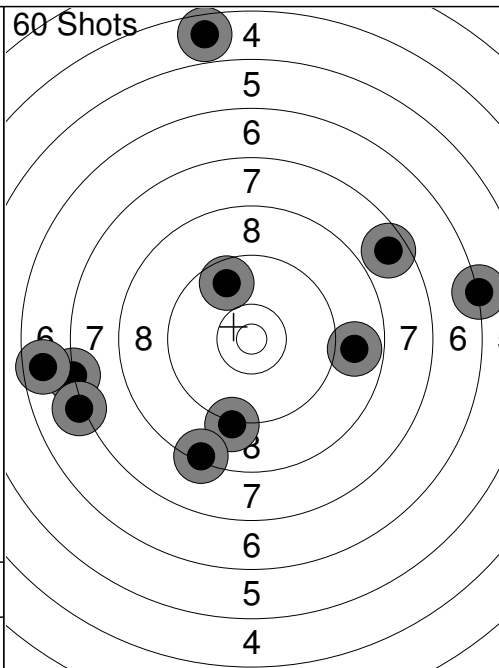

41:	6.2	→
42:	8.8	→
43:	7.2	←
44:	7.1	←
45:	4.6	↑
46:	6.6	←
47:	7.6	↗
48:	9.2	↓
49:	8.3	↓
50:	9.7	↖
Series	71 (0x)	
	310 (0x)	

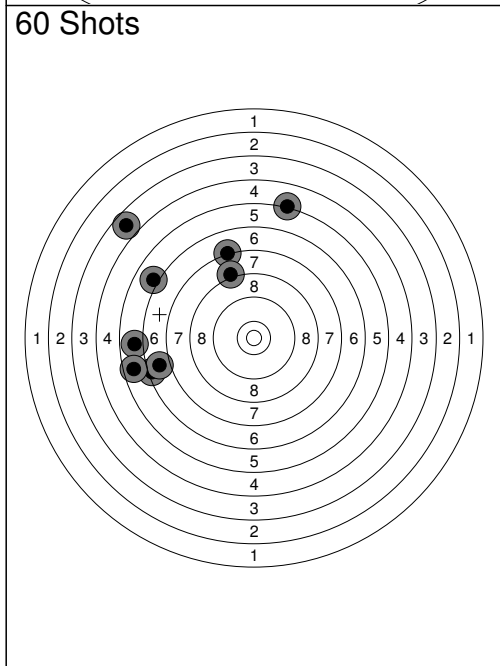

51:	6.0	↖
52:	5.2	↑
53:	7.2	↗
54:	6.4	←
55:	5.9	←
56:	6.8	←
57:	0.0	←
58:	3.7	↖
59:	5.7	←
60:	8.1	↖
Series	51 (0x)	
	361 (0x)	

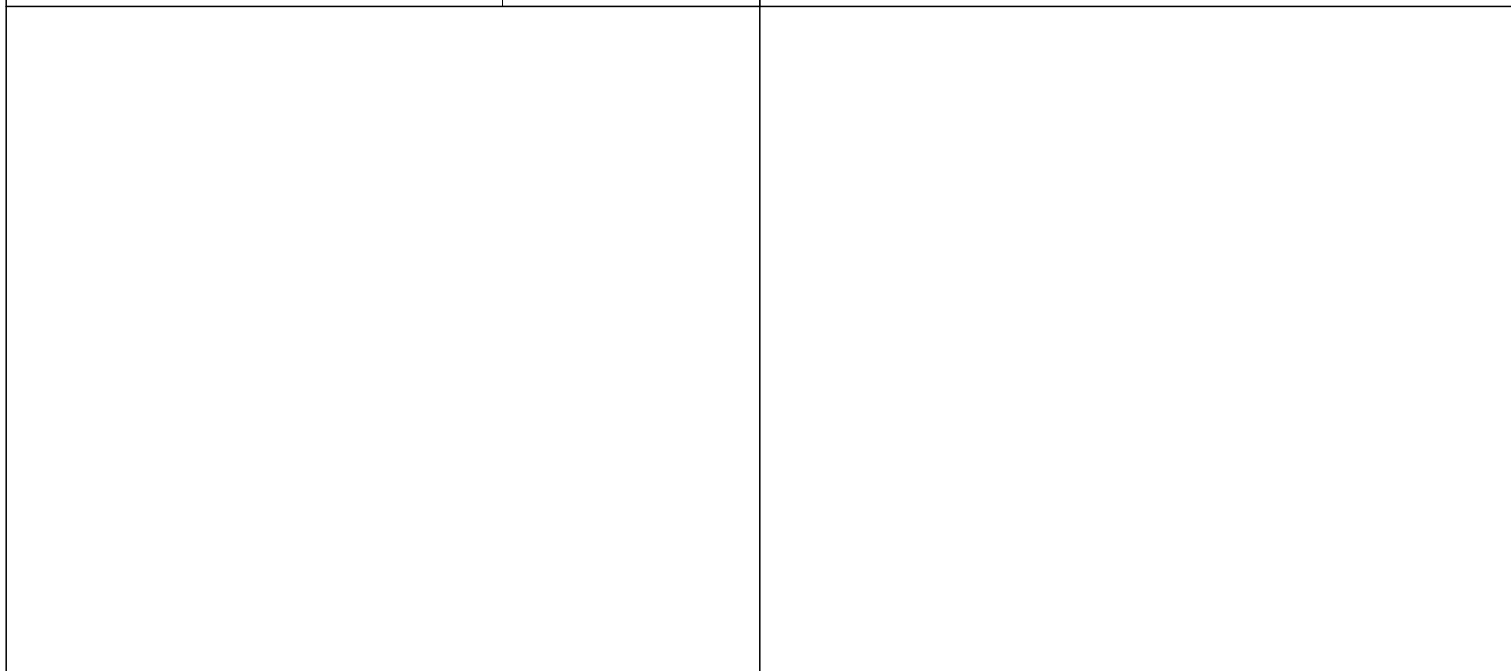

Relay **2** Lane **24** **LUO Max fangzhi**

2023 SFC Pistol Nationals BC SJ MP

15.07.2023 PN23AP-Q-1 Alberta Handgun Association

Comment Signature

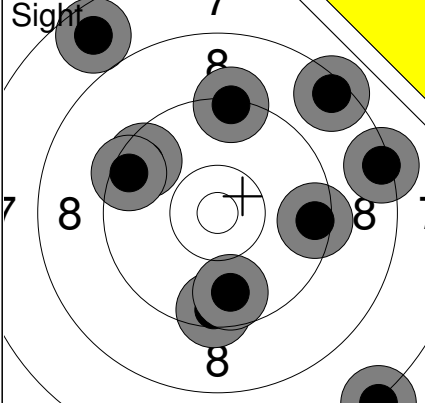
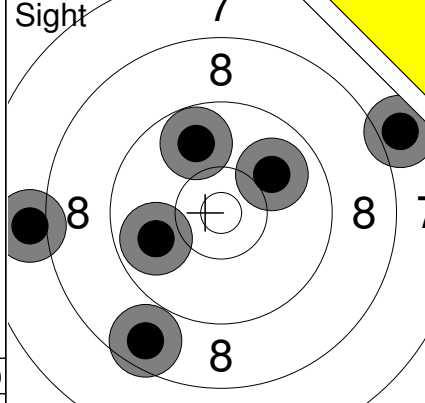
Sight		1: 9.5 ↓	Sight		11: 9.9 ←
		2: 9.6 ↗			
		3: 7.2 ↓			13: 10.0 ↗
		4: 9.7 ↓			14: 7.9 →
		5: 8.5 ↗			15: 8.6 ↓
		6: 9.5 →			16: 9.8 ↑
		7: 7.7 ↗			
		8: 9.5 ↖			
		9: 9.3 ↑			
		10: 8.4 →			
		Series 84 (0x)			Series 51 (0x)
		0 (0x)			0 (0x)

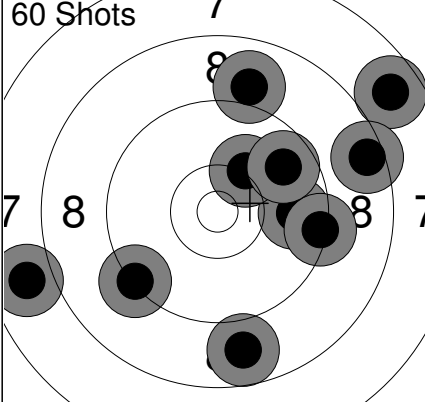
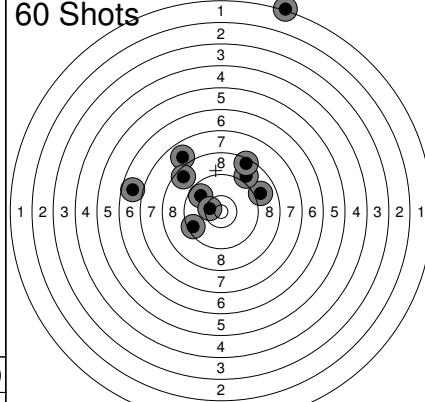
60 Shots		1: 7.7 ↗	60 Shots		11: 8.9 →
		2: 8.8 ↓			
		3: 8.5 →			13: 9.8 ↗
		4: 9.8 →			14: 8.6 ↗
		5: 9.3 →			15: 9.5 ←
		6: 10.2 ↗			16: 1.1 ↑
		7: 7.8 ←			17: 6.8 ←
		8: 9.3 ←			18: 8.9 ↗
		9: 9.0 ↑			19: 10.4x ←
		10: 9.7 ↗			20: 8.4 ↑
		Series 85 (0x)			Series 74 (1x)
		85 (0x)			159 (1x)

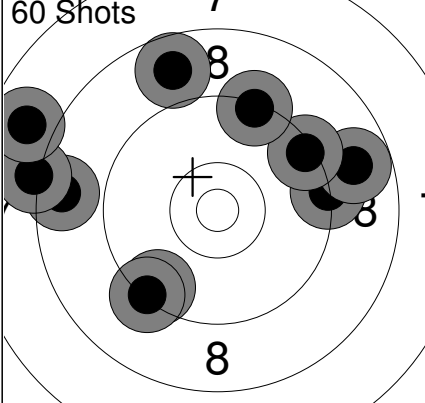
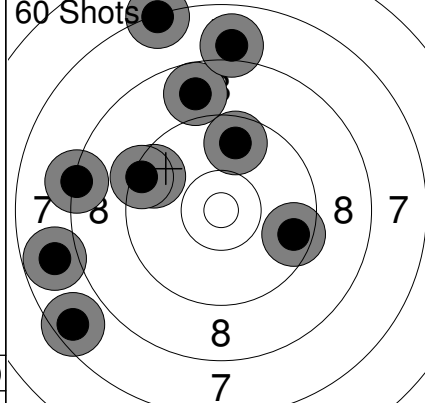
60 Shots		21: 9.5 ↓	60 Shots		31: 7.3 ↑
		22: 9.3 →			
		23: 8.8 →			33: 8.0 ↑
		24: 9.3 ↓			34: 9.6 →
		25: 9.4 ↗			35: 7.8 ←
		26: 8.6 ←			36: 9.6 ↖
		27: 9.3 ↑			37: 9.7 ↑
		28: 8.1 ←			38: 9.4 ←
		29: 8.8 ↑			39: 7.6 ↖
		30: 7.8 ←			40: 8.3 ←
		Series 84 (0x)			Series 81 (0x)
		243 (1x)			324 (1x)

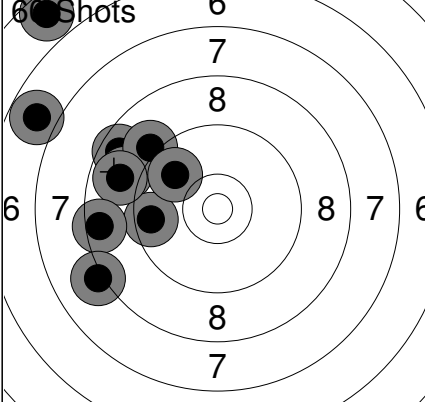
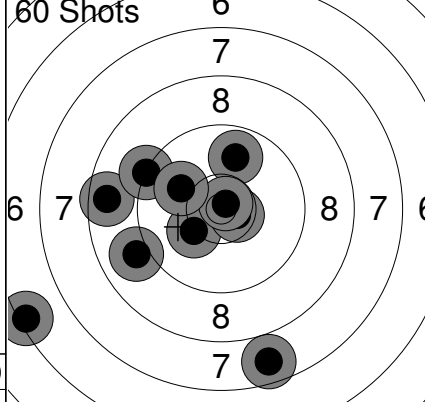
60 Shots		41: 8.6 ←	60 Shots		51: 9.9 ↑
		42: 8.9 ↖			
		43: 9.1 ↗			53: 10.2 ↖
		44: 9.6 ←			54: 10.6x →
		45: 8.9 ↖			55: 10.8x ↗
		46: 9.8 ↗			56: 7.7 ↓
		47: 8.5 ↖			57: 8.6 ←
		48: 6.8 ↗			58: 6.4 ←
		49: 5.6 ↗			59: 9.2 ↖
		50: 8.1 ←			60: 10.0 ↖
		Series 78 (0x)			Series 88 (2x)
		402 (1x)			490 (3x)

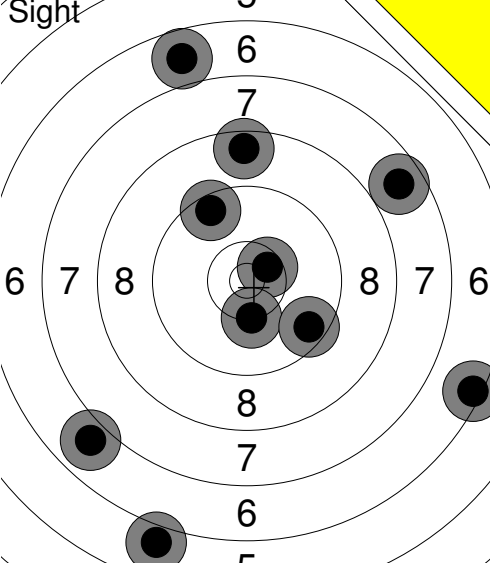
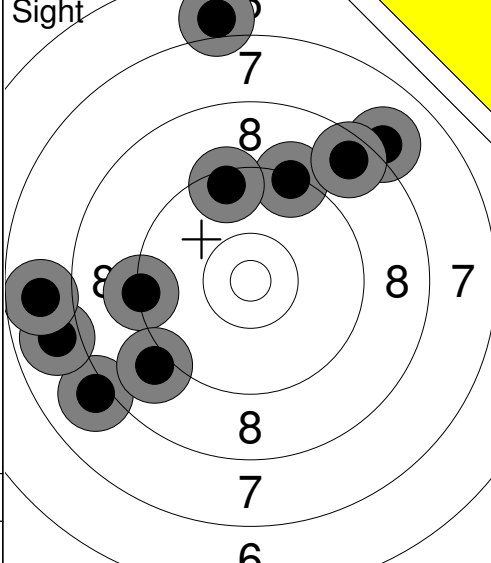
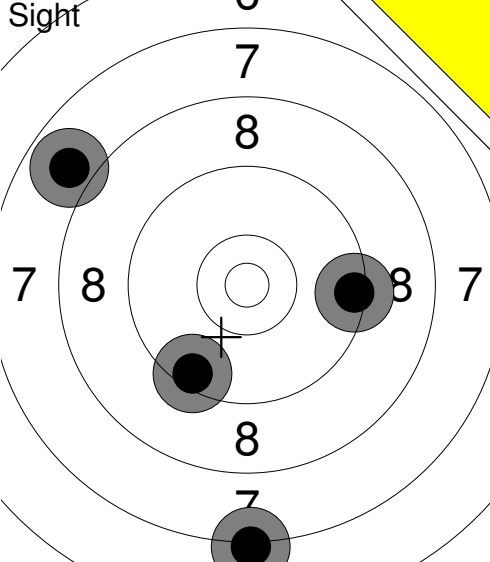
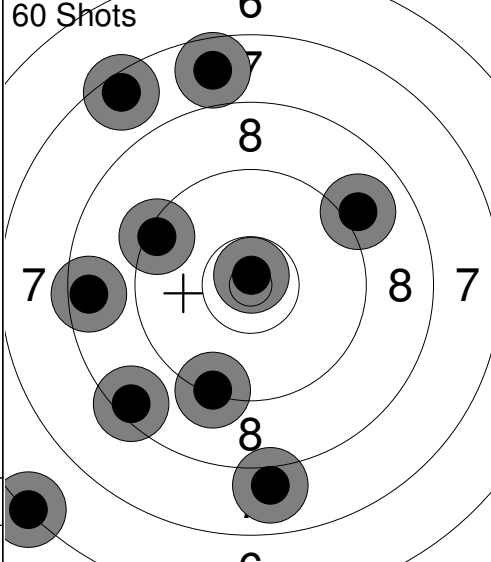
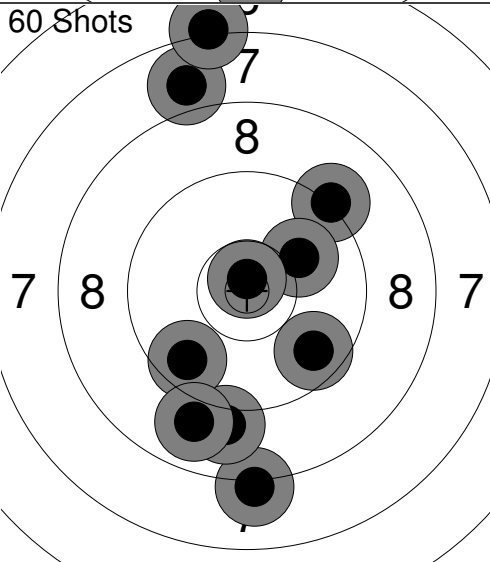
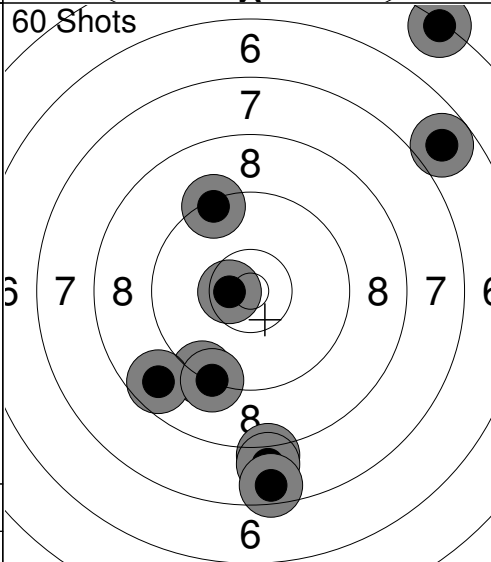

	<p>1: 9.5 ↗ 2: 6.9 ↘ 3: 6.4 → 4: 7.7 ↗ 5: 6.8 ↑ 6: 10.5x ↗ 7: 10.3 ↓ 8: 8.6 ↑ 9: 9.5 ↘ 10: 5.9 ↓</p> <p>Series 76 ( 1x) 0 ( 0x)</p>		<p>11: 9.3 ← 12: 9.3 ↑ 13: 6.9 ↑ 14: 8.0 ↘ 15: 7.9 ← 16: 8.1 ↗ 17: 9.0 ↘ 18: 9.4 ↑ 19: 7.8 ← 20: 8.6 ↗</p> <p>Series 80 ( 0x) 0 ( 0x)</p>
	<p>21: 9.4 → 22: 7.2 ↓ 23: 7.9 ↖ 24: 9.4 ↘</p> <p>Series 32 ( 0x) 0 ( 0x)</p>		<p>1: 9.4 ↖ 2: 8.5 ← 3: 7.7 ↑ 4: 8.4 ↘ 5: 7.5 ↖ 6: 10.8x ↑ 7: 9.0 ↗ 8: 6.3 ↘ 9: 9.3 ↓ 10: 8.0 ↓</p> <p>Series 81 ( 1x) 81 ( 1x)</p>
	<p>11: 7.9 ↑ 12: 9.7 ↘ 13: 7.2 ↑ 14: 8.1 ↓ 15: 9.2 ↗ 16: 10.1 ↗ 17: 9.0 ↓ 18: 10.8x ↑ 19: 9.6 ↘ 20: 8.9 ↓</p> <p>Series 86 ( 1x) 167 ( 2x)</p>		<p>21: 9.3 ↑ 22: 10.6x ← 23: 9.3 ↘ 24: 8.7 ↘ 25: 9.3 ↓ 26: 8.1 ↓ 27: 7.9 ↓ 28: 5.3 ↗ 29: 6.8 ↗ 30: 7.6 ↓</p> <p>Series 78 ( 1x) 245 ( 3x)</p>

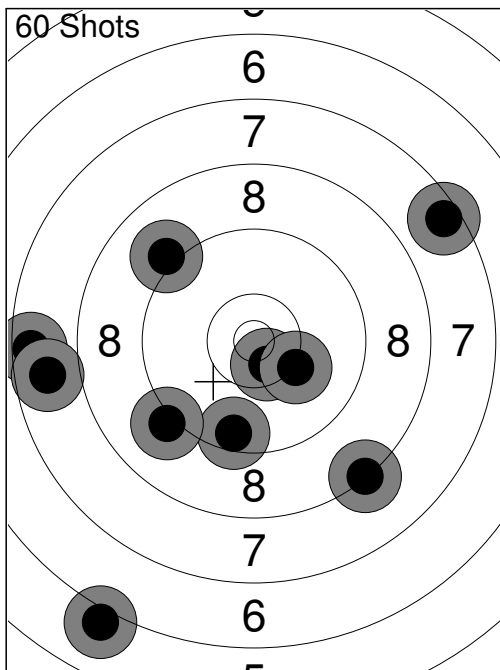

31:	7.5	←
32:	7.5	↗
33:	9.5	↓
34:	8.3	↘
35:	10.5x	↘
36:	7.7	←
37:	9.1	↙
38:	6.0	↓
39:	9.1	↗
40:	10.2	↘
Series	82 ( 1x)	
	327 ( 4x)	

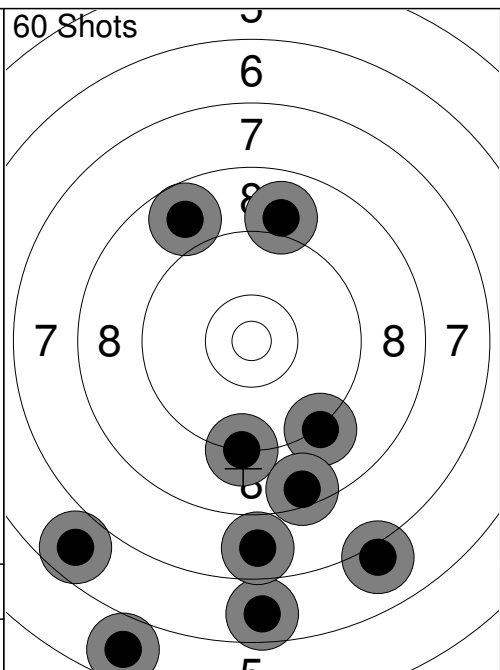

41:	5.7	↘
42:	9.0	↑
43:	8.8	↖
44:	9.2	↓
45:	6.7	↓
46:	9.2	↘
47:	7.7	↓
48:	6.7	↙
49:	7.0	↘
50:	8.5	↘
Series	74 ( 0x)	
	401 ( 4x)	

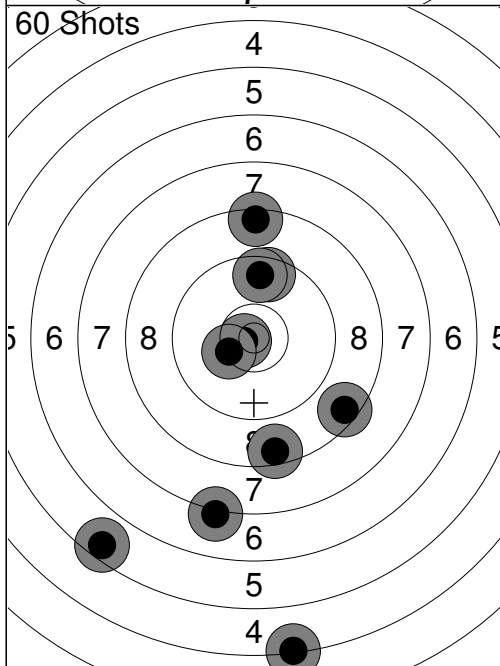

51:	9.6	↑
52:	9.6	↑
53:	5.5	↘
54:	10.7x	←
55:	8.5	↘
56:	4.3	↓
57:	8.4	↑
58:	10.3	↙
59:	8.5	↓
60:	7.1	↓
Series	78 ( 1x)	
	479 ( 5x)	

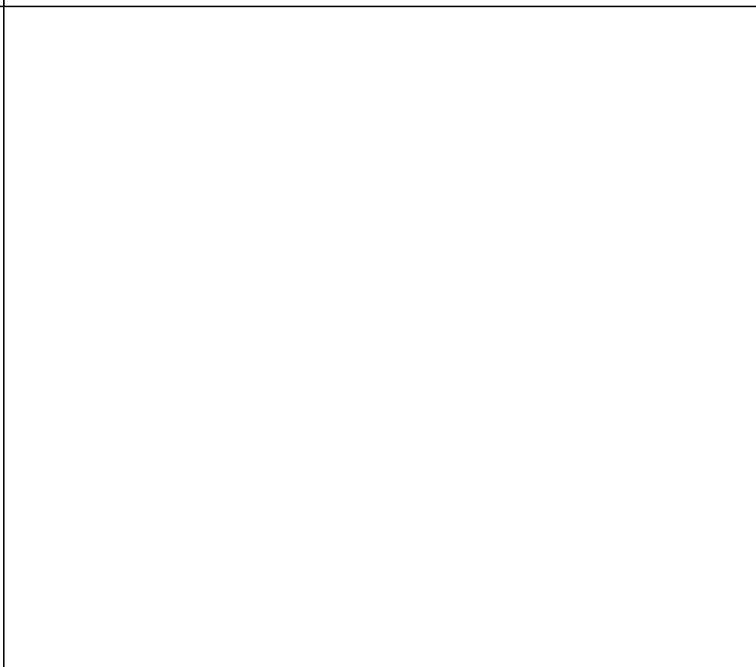
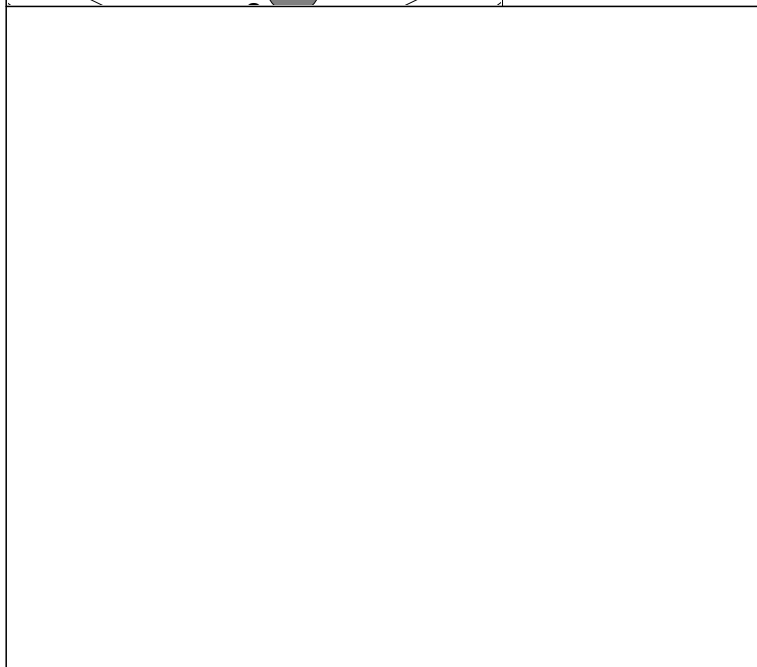

Comment	Signature		
---------	-----------	--	--

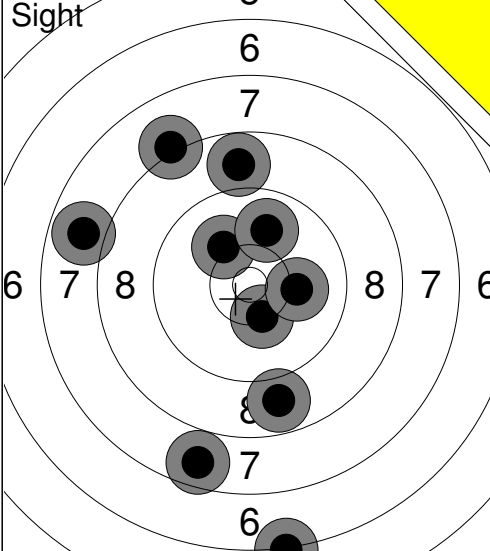
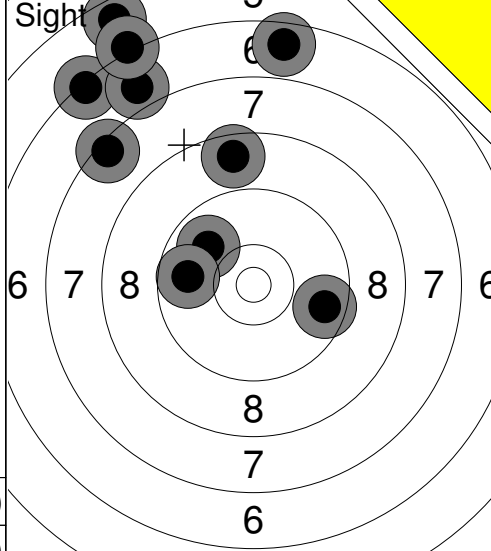
 <p>Sight</p>	<table border="1" style="width:100%; border-collapse: collapse;"> <tr><td>1:</td><td>10.3</td><td>↓</td></tr> <tr><td>2:</td><td>10.1</td><td>↗</td></tr> <tr><td>3:</td><td>9.9</td><td>↗</td></tr> <tr><td>4:</td><td>7.9</td><td>←</td></tr> <tr><td>5:</td><td>8.1</td><td>↗</td></tr> <tr><td>6:</td><td>8.8</td><td>↓</td></tr> <tr><td>7:</td><td>10.1</td><td>→</td></tr> <tr><td>8:</td><td>8.8</td><td>↑</td></tr> <tr><td>9:</td><td>6.2</td><td>↓</td></tr> <tr><td>10:</td><td>7.7</td><td>↓</td></tr> <tr><td>Series</td><td>83 (0x)</td><td></td></tr> <tr><td></td><td>0 (0x)</td><td></td></tr> </table>	1:	10.3	↓	2:	10.1	↗	3:	9.9	↗	4:	7.9	←	5:	8.1	↗	6:	8.8	↓	7:	10.1	→	8:	8.8	↑	9:	6.2	↓	10:	7.7	↓	Series	83 (0x)			0 (0x)		 <p>Sight</p> <table border="1" style="width:100%; border-collapse: collapse;"> <tr><td>11:</td><td>5.6</td><td>↗</td></tr> <tr><td>12:</td><td>6.3</td><td>↗</td></tr> <tr><td>13:</td><td>7.4</td><td>↗</td></tr> <tr><td>14:</td><td>9.6</td><td>→</td></tr> <tr><td>15:</td><td>8.6</td><td>↑</td></tr> <tr><td>16:</td><td>9.9</td><td>↗</td></tr> <tr><td>17:</td><td>6.8</td><td>↗</td></tr> <tr><td>18:</td><td>9.8</td><td>←</td></tr> <tr><td>19:</td><td>6.6</td><td>↑</td></tr> <tr><td>20:</td><td>6.1</td><td>↗</td></tr> <tr><td>Series</td><td>71 (0x)</td><td></td></tr> <tr><td></td><td>0 (0x)</td><td></td></tr> </table>	11:	5.6	↗	12:	6.3	↗	13:	7.4	↗	14:	9.6	→	15:	8.6	↑	16:	9.9	↗	17:	6.8	↗	18:	9.8	←	19:	6.6	↑	20:	6.1	↗	Series	71 (0x)			0 (0x)	
1:	10.3	↓																																																																								
2:	10.1	↗																																																																								
3:	9.9	↗																																																																								
4:	7.9	←																																																																								
5:	8.1	↗																																																																								
6:	8.8	↓																																																																								
7:	10.1	→																																																																								
8:	8.8	↑																																																																								
9:	6.2	↓																																																																								
10:	7.7	↓																																																																								
Series	83 (0x)																																																																									
	0 (0x)																																																																									
11:	5.6	↗																																																																								
12:	6.3	↗																																																																								
13:	7.4	↗																																																																								
14:	9.6	→																																																																								
15:	8.6	↑																																																																								
16:	9.9	↗																																																																								
17:	6.8	↗																																																																								
18:	9.8	←																																																																								
19:	6.6	↑																																																																								
20:	6.1	↗																																																																								
Series	71 (0x)																																																																									
	0 (0x)																																																																									

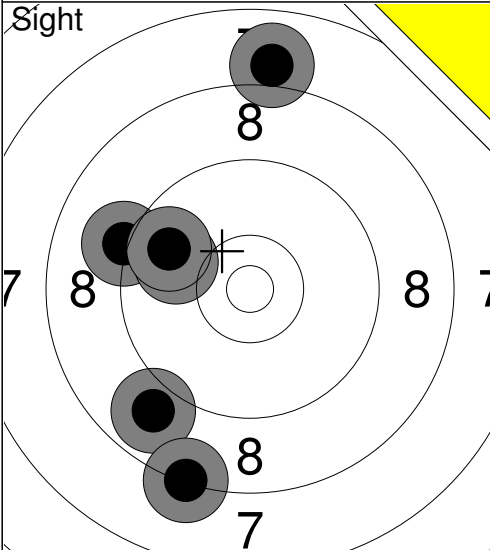
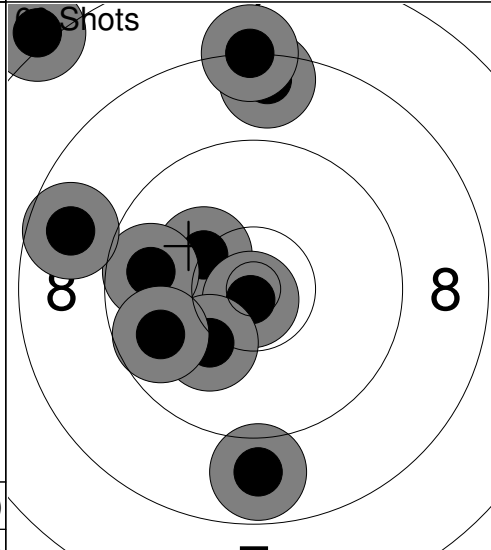
 <p>Sight</p>	<table border="1" style="width:100%; border-collapse: collapse;"> <tr><td>21:</td><td>8.9</td><td>↙</td></tr> <tr><td>22:</td><td>6.5</td><td>↗</td></tr> <tr><td>23:</td><td>9.2</td><td>←</td></tr> <tr><td>24:</td><td>9.9</td><td>←</td></tr> <tr><td>25:</td><td>9.8</td><td>←</td></tr> <tr><td>26:</td><td>8.0</td><td>↑</td></tr> <tr><td>27:</td><td>8.3</td><td>↓</td></tr> <tr><td>Series</td><td>57 (0x)</td><td></td></tr> <tr><td></td><td>0 (0x)</td><td></td></tr> </table>	21:	8.9	↙	22:	6.5	↗	23:	9.2	←	24:	9.9	←	25:	9.8	←	26:	8.0	↑	27:	8.3	↓	Series	57 (0x)			0 (0x)		 <p>Shots</p> <table border="1" style="width:100%; border-collapse: collapse;"> <tr><td>1:</td><td>10.3</td><td>←</td></tr> <tr><td>2:</td><td>8.5</td><td>↑</td></tr> <tr><td>3:</td><td>8.2</td><td>↑</td></tr> <tr><td>4:</td><td>10.8x</td><td>↓</td></tr> <tr><td>5:</td><td>9.7</td><td>←</td></tr> <tr><td>6:</td><td>8.8</td><td>↓</td></tr> <tr><td>7:</td><td>10.1</td><td>↙</td></tr> <tr><td>8:</td><td>9.8</td><td>←</td></tr> <tr><td>9:</td><td>7.1</td><td>↗</td></tr> <tr><td>10:</td><td>8.7</td><td>←</td></tr> <tr><td>Series</td><td>87 (1x)</td><td></td></tr> <tr><td></td><td>87 (1x)</td><td></td></tr> </table>	1:	10.3	←	2:	8.5	↑	3:	8.2	↑	4:	10.8x	↓	5:	9.7	←	6:	8.8	↓	7:	10.1	↙	8:	9.8	←	9:	7.1	↗	10:	8.7	←	Series	87 (1x)			87 (1x)	
21:	8.9	↙																																																															
22:	6.5	↗																																																															
23:	9.2	←																																																															
24:	9.9	←																																																															
25:	9.8	←																																																															
26:	8.0	↑																																																															
27:	8.3	↓																																																															
Series	57 (0x)																																																																
	0 (0x)																																																																
1:	10.3	←																																																															
2:	8.5	↑																																																															
3:	8.2	↑																																																															
4:	10.8x	↓																																																															
5:	9.7	←																																																															
6:	8.8	↓																																																															
7:	10.1	↙																																																															
8:	9.8	←																																																															
9:	7.1	↗																																																															
10:	8.7	←																																																															
Series	87 (1x)																																																																
	87 (1x)																																																																

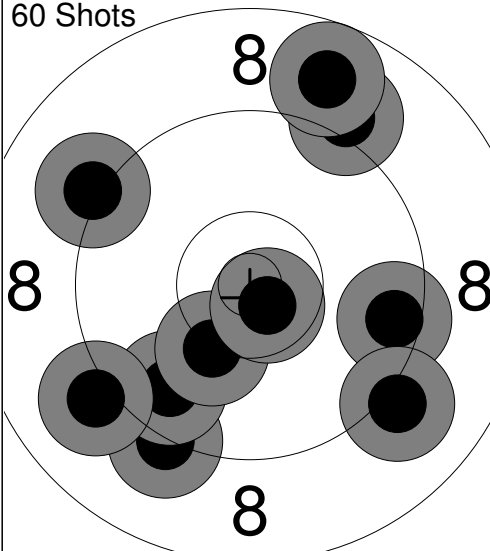
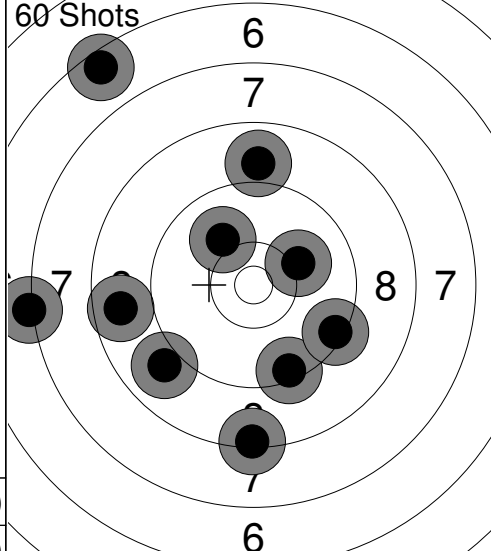
 <p>60 Shots</p>	<table border="1" style="width:100%; border-collapse: collapse;"> <tr><td>11:</td><td>9.2</td><td>↙</td></tr> <tr><td>12:</td><td>9.7</td><td>↙</td></tr> <tr><td>13:</td><td>9.1</td><td>↗</td></tr> <tr><td>14:</td><td>9.1</td><td>↗</td></tr> <tr><td>15:</td><td>10.2</td><td>↙</td></tr> <tr><td>16:</td><td>9.5</td><td>→</td></tr> <tr><td>17:</td><td>9.1</td><td>↙</td></tr> <tr><td>18:</td><td>8.8</td><td>↑</td></tr> <tr><td>19:</td><td>10.7x</td><td>↙</td></tr> <tr><td>20:</td><td>9.1</td><td>←</td></tr> <tr><td>Series</td><td>91 (1x)</td><td></td></tr> <tr><td></td><td>178 (2x)</td><td></td></tr> </table>	11:	9.2	↙	12:	9.7	↙	13:	9.1	↗	14:	9.1	↗	15:	10.2	↙	16:	9.5	→	17:	9.1	↙	18:	8.8	↑	19:	10.7x	↙	20:	9.1	←	Series	91 (1x)			178 (2x)		 <p>60 Shots</p> <table border="1" style="width:100%; border-collapse: collapse;"> <tr><td>21:</td><td>8.9</td><td>↙</td></tr> <tr><td>22:</td><td>10.0</td><td>↗</td></tr> <tr><td>23:</td><td>6.5</td><td>↗</td></tr> <tr><td>24:</td><td>9.4</td><td>↓</td></tr> <tr><td>25:</td><td>8.9</td><td>↑</td></tr> <tr><td>26:</td><td>8.7</td><td>←</td></tr> <tr><td>27:</td><td>8.3</td><td>↓</td></tr> <tr><td>28:</td><td>9.4</td><td>→</td></tr> <tr><td>29:</td><td>10.1</td><td>↗</td></tr> <tr><td>30:</td><td>7.2</td><td>←</td></tr> <tr><td>Series</td><td>83 (0x)</td><td></td></tr> <tr><td></td><td>261 (2x)</td><td></td></tr> </table>	21:	8.9	↙	22:	10.0	↗	23:	6.5	↗	24:	9.4	↓	25:	8.9	↑	26:	8.7	←	27:	8.3	↓	28:	9.4	→	29:	10.1	↗	30:	7.2	←	Series	83 (0x)			261 (2x)	
11:	9.2	↙																																																																								
12:	9.7	↙																																																																								
13:	9.1	↗																																																																								
14:	9.1	↗																																																																								
15:	10.2	↙																																																																								
16:	9.5	→																																																																								
17:	9.1	↙																																																																								
18:	8.8	↑																																																																								
19:	10.7x	↙																																																																								
20:	9.1	←																																																																								
Series	91 (1x)																																																																									
	178 (2x)																																																																									
21:	8.9	↙																																																																								
22:	10.0	↗																																																																								
23:	6.5	↗																																																																								
24:	9.4	↓																																																																								
25:	8.9	↑																																																																								
26:	8.7	←																																																																								
27:	8.3	↓																																																																								
28:	9.4	→																																																																								
29:	10.1	↗																																																																								
30:	7.2	←																																																																								
Series	83 (0x)																																																																									
	261 (2x)																																																																									

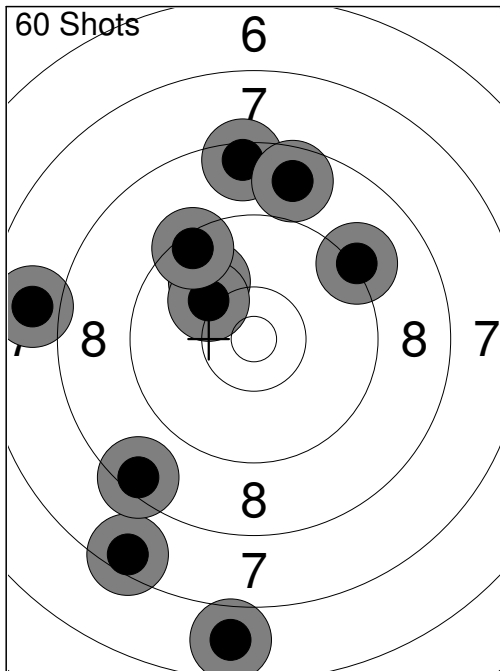

31:	9.9	↖
32:	8.5	↑
33:	6.8	↓
34:	8.7	↑
35:	7.5	↘
36:	8.5	↘
37:	9.2	↗
38:	10.1	↖
39:	7.9	←
40:	9.4	↖
Series	81 ( 0x)	
	342 ( 2x)	

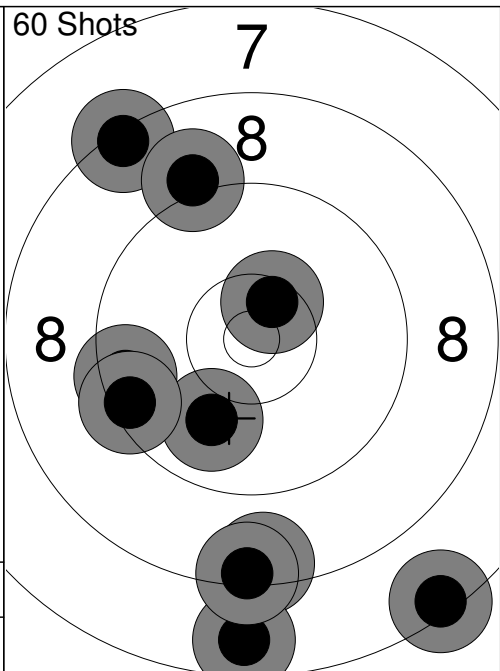

41:	7.4	↘
42:	10.0	↘
43:	10.5x	↗
44:	8.5	↓
45:	7.6	↓
46:	9.5	←
47:	9.4	←
48:	8.3	↖
49:	8.4	↓
50:	9.1	↖
Series	85 ( 1x)	
	427 ( 3x)	

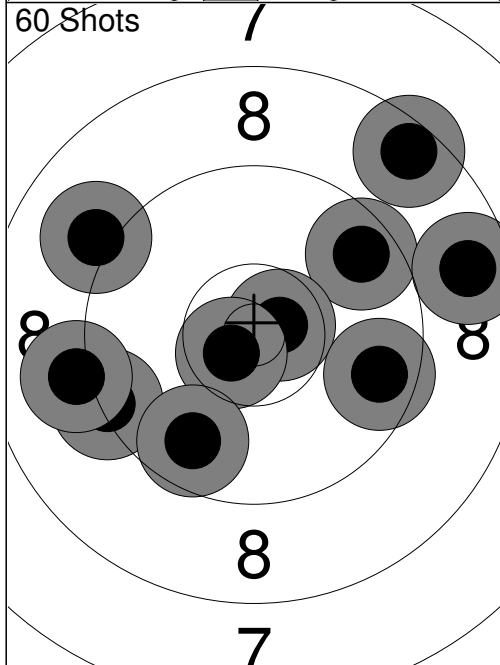

51:	9.6	↗
52:	10.7x	→
53:	10.7x	↙
54:	9.3	←
55:	8.7	→
56:	9.6	→
57:	8.5	↗
58:	9.1	←
59:	9.7	↘
60:	9.1	↖
Series	90 ( 2x)	
	517 ( 5x)	

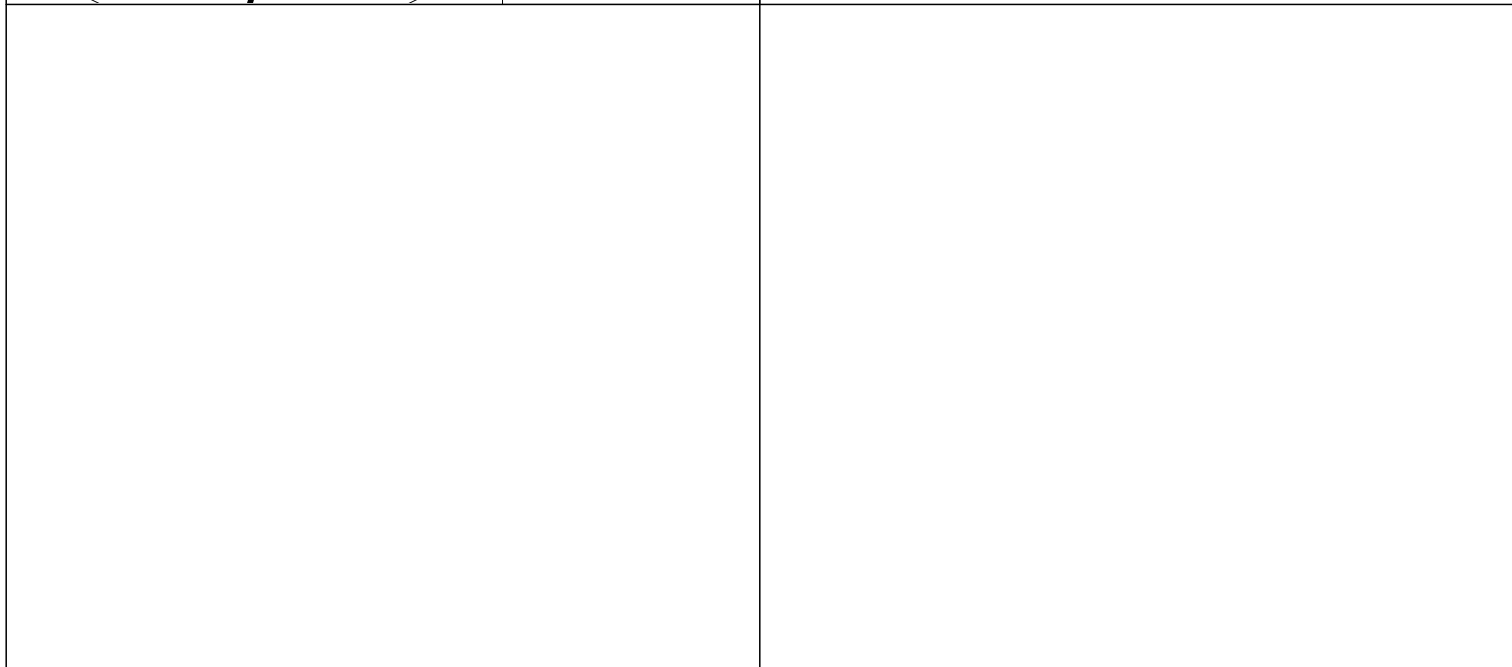

<p>Sight</p>	<p>1: 9.0 ↙ 2: 9.8 ↓ 3: 9.2 ↙ 4: 10.0 ↖ 5: 9.9 ↓ 6: 5.7 ↓ 7: 10.0 → 8: 9.0 ↑ 9: 8.6 ↓ 10: 8.4 ↓</p> <p>Series 86 (0x) 0 (0x)</p>	<p>Sight</p>	<p>11: 9.6 ↓ 12: 8.1 ↓ 13: 10.3 ↗ 14: 9.7 → 15: 9.8 →</p> <p>Series 45 (0x) 0 (0x)</p>
<p>60 Shots</p>	<p>1: 10.3 → 2: 7.4 ↓ 3: 8.9 ↖ 4: 8.6 ↓ 5: 10.5x ↓ 6: 9.9 → 7: 9.9 → 8: 9.8 → 9: 10.1 ↓ 10: 9.2 ↑</p> <p>Series 89 (1x) 89 (1x)</p>	<p>60 Shots</p>	<p>11: 9.2 → 12: 9.4 ↓ 13: 10.0 ↗ 14: 10.2 ↖ 15: 9.0 ↓ 16: 10.2 ↑ 17: 10.1 ↑ 18: 9.7 ↖ 19: 9.9 ↖ 20: 10.1 ↓</p> <p>Series 95 (0x) 184 (1x)</p>
<p>60 Shots</p>	<p>21: 10.7x → 22: 9.6 ↗ 23: 9.3 ↖ 24: 9.2 → 25: 8.8 ↓ 26: 10.3 ↖ 27: 9.3 → 28: 9.6 ↗ 29: 9.5 → 30: 10.7x ↑</p> <p>Series 92 (2x) 276 (3x)</p>	<p>60 Shots</p>	<p>31: 9.6 ↗ 32: 8.6 ↗ 33: 9.3 ↗ 34: 9.7 ↖ 35: 10.6x ↓ 36: 10.7x ↓ 37: 9.9 ↑ 38: 10.2 ↖ 39: 9.2 ↓ 40: 9.8 ↗</p> <p>Series 92 (2x) 368 (5x)</p>
<p>60 Shots</p>	<p>41: 9.9 ↑ 42: 10.2 → 43: 9.9 ↗ 44: 10.3 ↖ 45: 10.6x ↖ 46: 10.1 → 47: 10.7x ↖ 48: 10.6x ↖ 49: 9.5 ↓ 50: 10.1 ↗</p> <p>Series 97 (3x) 465 (8x)</p>	<p>60 Shots</p>	<p>51: 9.7 ↓ 52: 10.0 → 53: 9.5 ↖ 54: 9.9 → 55: 9.3 → 56: 8.9 ↖ 57: 7.9 ↓ 58: 10.4x ↖ 59: 8.4 ↓ 60: 6.3 ↖</p> <p>Series 85 (1x) 550 (9x)</p>

Relay <b>2</b>	Lane <b>28</b>	<b>DU Max</b>
-------------------	-------------------	---------------

2023 SFC Pistol Nationals	AB	JR	MP
---------------------------	----	----	----

15.07.2023	PN23AP-Q-1	Alberta Handgun Association
------------	------------	-----------------------------

Comment	Signature
---------	-----------

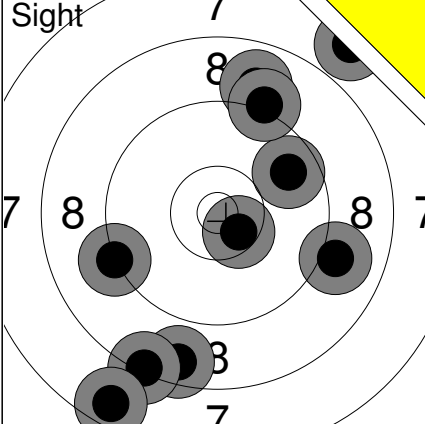
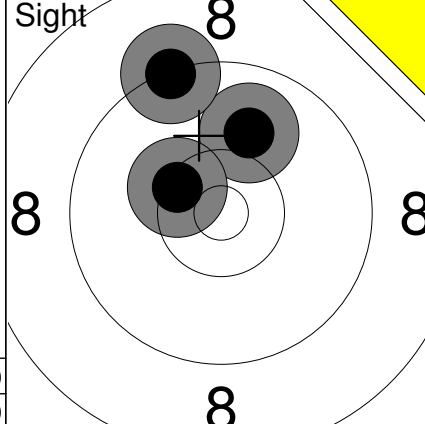
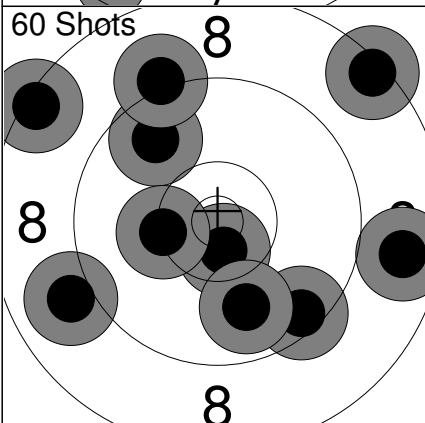
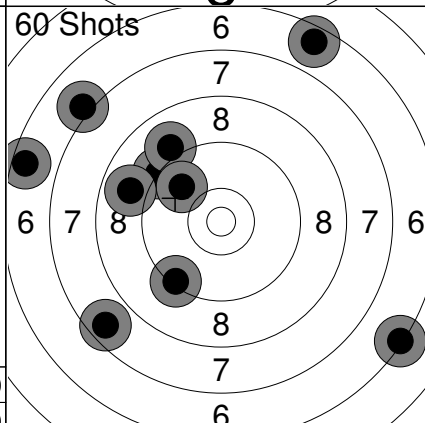
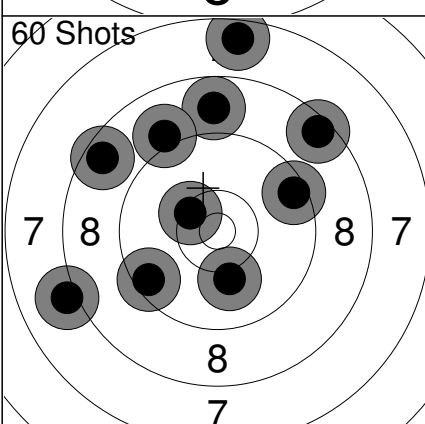
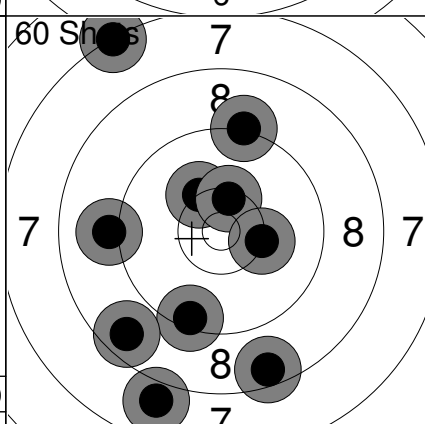
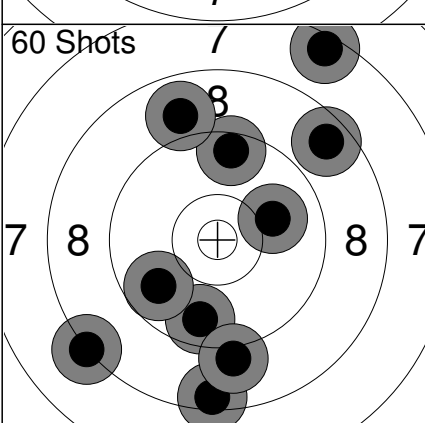
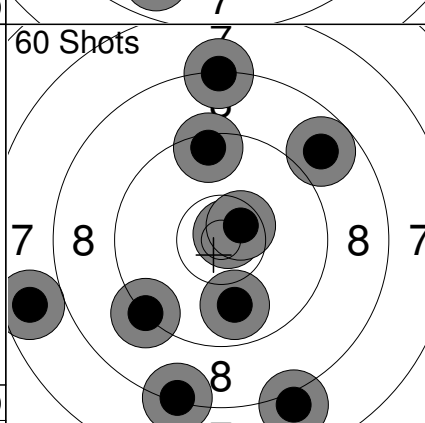
<p>Sight</p> 	<p>1: 10.5x ↘ 2: 8.9 ↑ 3: 9.7 → 4: 8.6 ↓ 5: 9.2 ← 6: 8.3 ↓ 7: 7.6 ↓ 8: 9.1 ↑ 9: 7.6 ↗ 10: 9.0 →</p> <p>Series 84 (1x) 0 (0x)</p>	<p>Sight</p> 	<p>11: 10.0 ↑ 12: 10.4x ↖ 13: 9.3 ↑</p> <p>Series 29 (1x) 0 (0x)</p>
<p>60 Shots</p> 	<p>1: 10.6x ↓ 2: 8.7 → 3: 9.7 ↗ 4: 8.4 ↗ 5: 10.3 ← 6: 9.5 ↓ 7: 9.1 ↗ 8: 9.0 ← 9: 9.9 ↓ 10: 8.4 ↗</p> <p>Series 89 (1x) 89 (1x)</p>	<p>60 Shots</p> 	<p>11: 6.6 ↑ 12: 9.2 ↗ 13: 7.1 ↗ 14: 7.6 ↘ 15: 9.3 ↘ 16: 9.0 ↗ 17: 9.8 ↗ 18: 6.3 ↘ 19: 8.9 ↖ 20: 6.5 ↖</p> <p>Series 76 (0x) 165 (1x)</p>
<p>60 Shots</p> 	<p>21: 7.6 ↑ 22: 8.8 ↑ 23: 8.1 ← 24: 8.6 ↖ 25: 9.5 ← 26: 8.5 ↗ 27: 10.1 ↓ 28: 9.5 → 29: 10.4x ↖ 30: 9.0 ↗</p> <p>Series 86 (1x) 251 (2x)</p>	<p>60 Shots</p> 	<p>31: 10.2 ↖ 32: 7.9 ↓ 33: 9.4 ↓ 34: 9.2 ↑ 35: 10.4x ↑ 36: 8.6 ↘ 37: 8.5 ↓ 38: 9.1 ← 39: 7.3 ↗ 40: 10.3 →</p> <p>Series 87 (1x) 338 (3x)</p>
<p>60 Shots</p> 	<p>41: 8.4 ↓ 42: 7.4 ↗ 43: 9.5 ↑ 44: 8.6 ↗ 45: 9.7 ↓ 46: 8.2 ↖ 47: 9.8 ↖ 48: 10.0 → 49: 9.0 ↓ 50: 8.9 ↑</p> <p>Series 85 (0x) 423 (3x)</p>	<p>60 Shots</p> 	<p>51: 10.8x ↗ 52: 8.0 ↓ 53: 10.6x ↗ 54: 9.9 ↓ 55: 8.3 ↓ 56: 7.7 ← 57: 9.4 ↑ 58: 8.8 ↗ 59: 8.3 ↑ 60: 9.2 ↘</p> <p>Series 86 (2x) 509 (5x)</p>



Relay **2** Lane **29** **FU Daniel yuhui**

2023 SFC Pistol Nationals BC IJ MP

15.07.2023 PN23AP-Q-1 Alberta Handgun Association

Comment Signature

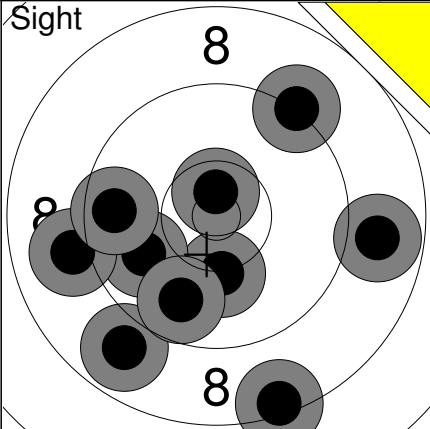
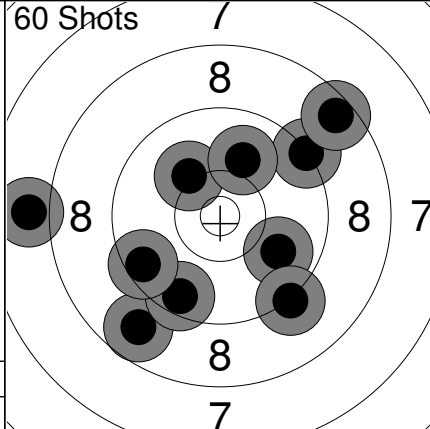
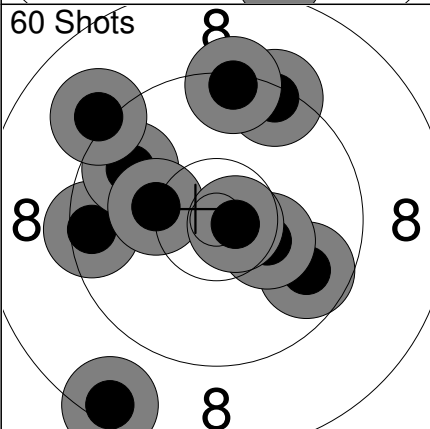
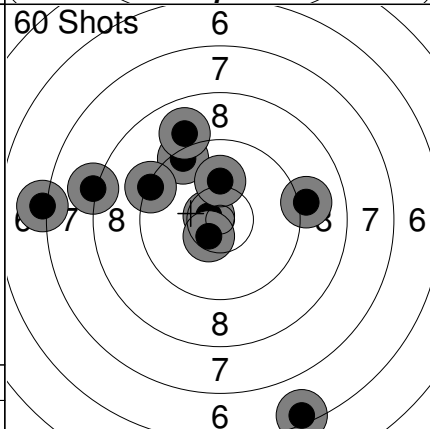
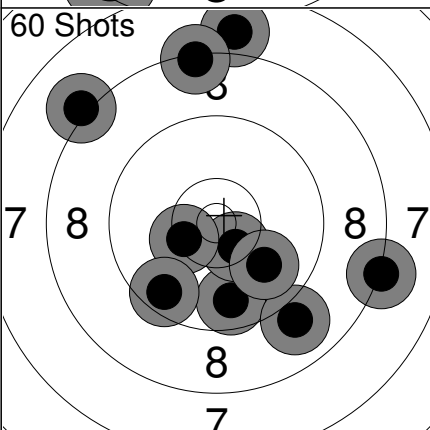
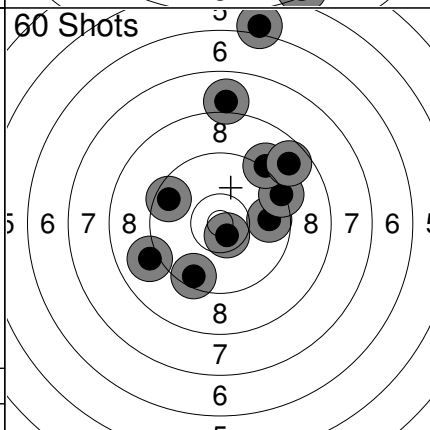
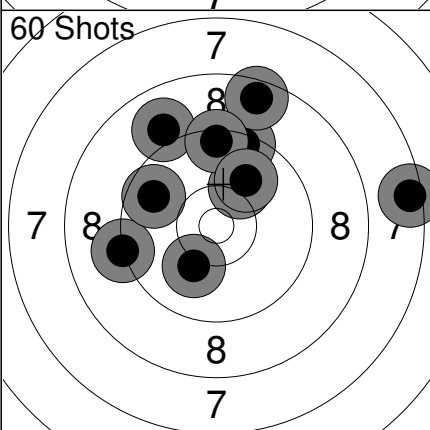
<p>Sight</p> 	<p>1: 8.8 → 2: 10.2 ↓ 3: 9.9 ← 4: 9.2 ↗ 5: 9.0 ← 6: 8.4 ↓ 7: 9.6 ← 8: 8.9 ↓ 9: 10.6x ↑ 10: 9.8 ↓</p> <p>Series 89 (1x) 0 (0x)</p>	<p>60 Shots 7</p> 	<p>1: 9.3 ↗ 2: 9.9 ↘ 3: 7.9 ← 4: 9.2 ↘ 5: 10.1 ↗ 6: 8.5 ↗ 7: 10.0 ↑ 8: 8.8 ↓ 9: 9.5 ↓ 10: 9.5 ↙</p> <p>Series 88 (0x) 88 (0x)</p>
<p>60 Shots</p> 	<p>11: 9.7 → 12: 8.5 ↓ 13: 9.5 ← 14: 10.3 → 15: 9.4 ↑ 16: 9.8 ↗ 17: 10.2 ← 18: 9.4 ↑ 19: 9.1 ↗ 20: 10.7x →</p> <p>Series 92 (1x) 180 (1x)</p>	<p>60 Shots 6</p> 	<p>21: 10.7x ← 22: 6.4 ↓ 23: 8.2 ← 24: 9.1 → 25: 9.4 ↗ 26: 9.0 ↑ 27: 7.1 ← 28: 10.5x ↓ 29: 9.3 ← 30: 10.1 ↑</p> <p>Series 87 (2x) 267 (3x)</p>
<p>60 Shots</p> 	<p>31: 9.7 ↓ 32: 8.2 → 33: 10.5x ↓ 34: 10.4x ← 35: 8.1 ↗ 36: 7.9 ↑ 37: 9.6 ↓ 38: 9.0 ↓ 39: 9.9 ↓ 40: 8.3 ↑</p> <p>Series 87 (2x) 354 (5x)</p>	<p>60 Shots 5</p> 	<p>41: 10.6x ↓ 42: 9.7 → 43: 9.0 ← 44: 9.5 ↓ 45: 9.3 → 46: 9.6 ↖ 47: 8.0 ↑ 48: 6.0 ↑ 49: 9.1 ↗ 50: 8.7 ↗</p> <p>Series 86 (1x) 440 (6x)</p>
<p>60 Shots</p> 	<p>51: 10.1 ↓ 52: 9.4 ↑ 53: 8.6 ↑ 54: 10.1 ↗ 55: 9.0 ↗ 56: 9.2 ← 57: 9.4 ↑ 58: 9.7 ↖ 59: 10.0 ↗ 60: 7.4 →</p> <p>Series 90 (0x) 530 (6x)</p>		

Comment	Signature		
---------	-----------	--	--

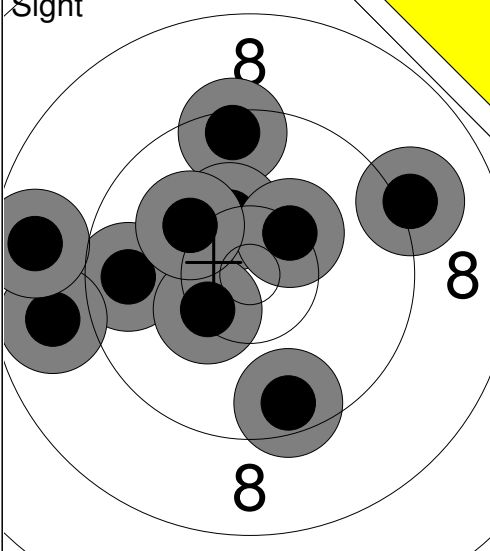
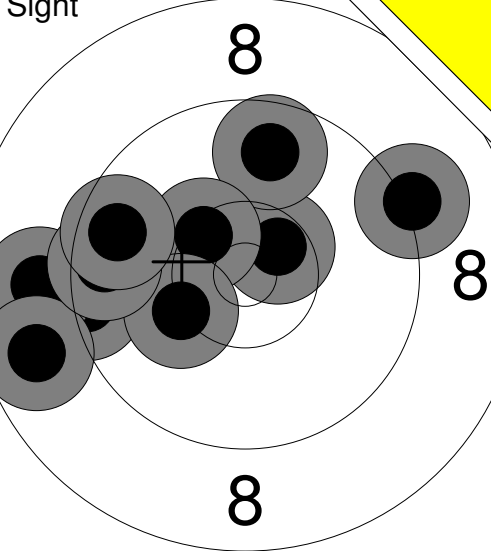
<p>Sight</p> 	<p>1: 9.5 ↑ 2: 9.7 ← 3: 9.1 → 4: 9.6 ↓ 5: 10.3 ↑ 6: 8.8 ← 7: 10.4 → 8: 10.4x ← 9: 8.7 ← 10: 10.1 ↖</p> <p>Series 92 ( 1x) 0 ( 0x)</p>	<p>Sight</p> 	<p>11: 9.4 ← 12: 9.2 → 13: 10.5x ↗ 14: 8.9 ← 15: 9.7 ↑ 16: 8.8 ← 17: 10.4x ↖ 18: 10.2 ← 19: 9.6 ← 20: 9.6 ←</p> <p>Series 91 ( 2x) 0 ( 0x)</p>
---	---	---	--

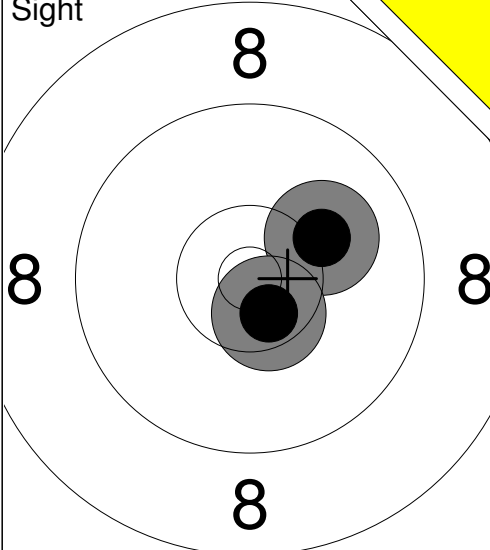
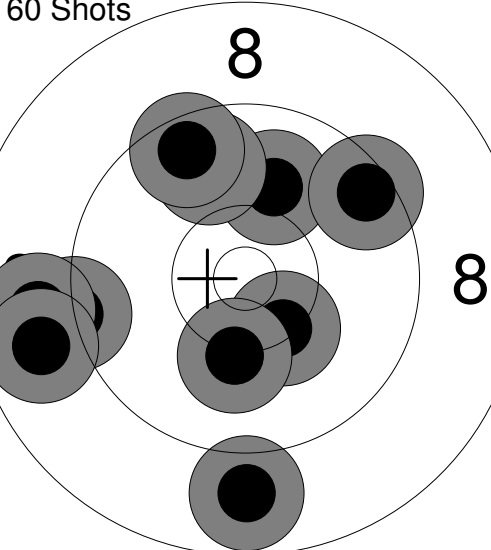
<p>Sight</p> 	<p>21: 10.1 → 22: 10.6x ↓</p> <p>Series 20 ( 1x) 0 ( 0x)</p>	<p>60 Shots</p> 	<p>1: 9.2 ← 2: 8.9 ← 3: 10.0 ↑ 4: 8.8 ↓ 5: 10.3 ↓ 6: 9.5 → 7: 9.8 ↑ 8: 9.6 ↑ 9: 8.8 ← 10: 10.2 ↓</p> <p>Series 90 ( 0x) 90 ( 0x)</p>
--	--	---	--

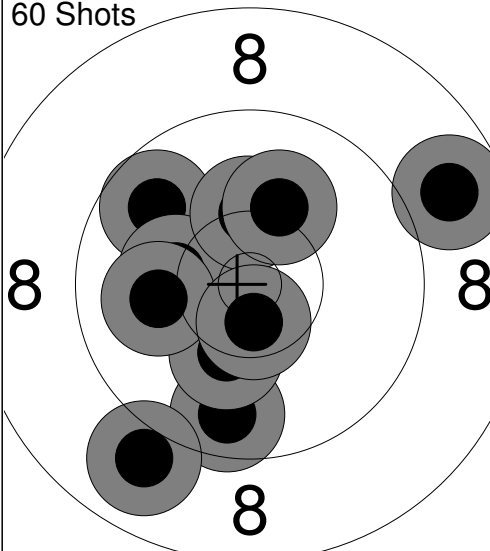
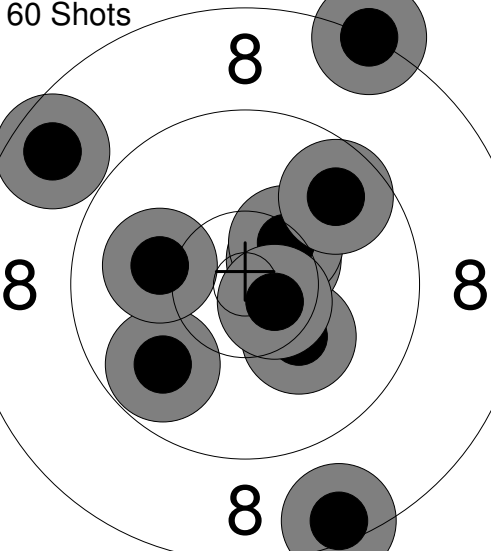
<p>60 Shots</p> 	<p>11: 9.6 ↓ 12: 8.8 → 13: 9.8 ↖ 14: 10.2 ↓ 15: 10.2 ← 16: 10.2 ↑ 17: 10.1 ↑ 18: 10.0 ← 19: 9.0 ↓ 20: 10.6x ↓</p> <p>Series 95 ( 1x) 185 ( 1x)</p>	<p>60 Shots</p> 	<p>21: 10.2 ↓ 22: 9.8 ↖ 23: 8.2 ↑ 24: 8.6 ↖ 25: 10.1 ← 26: 10.5x ↗ 27: 10.4x ↗ 28: 9.7 ↗ 29: 10.6x ↘ 30: 8.4 ↓</p> <p>Series 92 ( 3x) 277 ( 4x)</p>
--	--	--	---

Relay <b>2</b>	Lane <b>1</b>	<b>FU Daniel yuhui</b>
-------------------	------------------	------------------------

2023 SFC Pistol Nationals	BC	IJ	MP
---------------------------	----	----	----

16.07.2023	23PN-AP-Q2	Alberta Handgun Association
------------	------------	-----------------------------

Comment	Signature
---------	-----------

<b>Sight</b> 	1: 9.0 ↗ 2: 10.2 ↖ 3: 9.4 ↗ 4: 9.3 → 5: 8.8 → 6: 8.1 ↗ 7: 8.1 ↘ 8: 9.9 ↖ 9: 9.0 ↗ 10: 7.8 ↖	<b>Sight</b> 	11: 9.7 ↖ 12: 9.9 ↓ 13: 7.7 ↘ 14: 9.4 → 15: 8.6 ↖ 16: 9.6 ↓
	Series 86 (0x) 0 (0x)		Series 51 (0x) 0 (0x)
<b>60 Shots</b> 	1: 9.6 ↗ 2: 9.3 ↖ 3: 9.4 ↖ 4: 9.0 ↘ 5: 8.5 ↘ 6: 10.4x ↘ 7: 9.5 ↘ 8: 9.0 ↘ 9: 9.3 ↘ 10: 9.3 ↖	<b>60 Shots</b> 	11: 8.9 → 12: 8.5 → 13: 9.1 → 14: 10.2 ← 15: 10.8x → 16: 9.8 ↗ 17: 8.3 ↘ 18: 9.3 → 19: 9.4 ↗ 20: 8.1 ↗
	Series 90 (1x) 90 (1x)		Series 88 (1x) 178 (2x)
<b>60 Shots</b> 	21: 9.6 → 22: 7.8 → 23: 9.2 ↖ 24: 9.5 ↗ 25: 8.7 ↘ 26: 8.9 ↖ 27: 7.8 ↘ 28: 9.7 → 29: 9.5 → 30: 9.9 ←	<b>60 Shots</b> 	31: 9.1 ↑ 32: 9.0 ↘ 33: 10.3 ↘ 34: 9.2 ↗ 35: 8.4 ↘ 36: 10.3 ↘ 37: 9.5 ↘ 38: 8.6 → 39: 9.8 ↖ 40: 9.3 ↓
	Series 84 (0x) 262 (2x)		Series 90 (0x) 352 (2x)
<b>60 Shots</b> 	41: 7.1 → 42: 8.2 ↘ 43: 9.3 ↗ 44: 10.0 ↖ 45: 10.7x → 46: 10.3 ↗ 47: 9.1 → 48: 10.0 ↗ 49: 8.5 ↗ 50: 9.7 ←	<b>60 Shots</b> 	51: 9.1 → 52: 9.7 ← 53: 8.0 → 54: 8.1 → 55: 8.6 ↗ 56: 8.4 ↗ 57: 10.5x ↘ 58: 9.9 ↗ 59: 8.9 → 60: 9.2 ←
	Series 90 (1x) 442 (3x)		Series 86 (1x) 528 (4x)

Relay **2** Lane **2** **DU Max**

2023 SFC Pistol Nationals AB JR MP

16.07.2023 23PN-AP-Q2 Alberta Handgun Association

Comment Signature

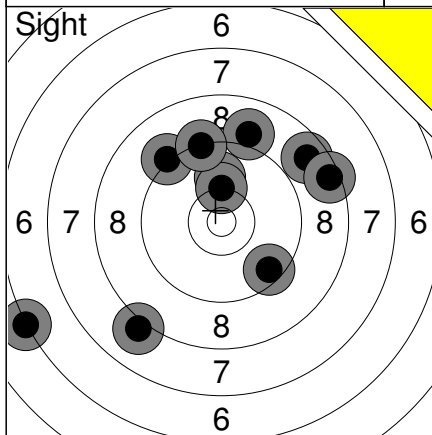

1:	10.0	↑
2:	10.2	↑
3:	8.1	↙
4:	9.0	↑
5:	6.2	↙
6:	9.2	↗
7:	8.7	↗
8:	9.5	↘
9:	9.3	↑
10:	8.4	↗
Series	86 (0x)	
	0 (0x)	

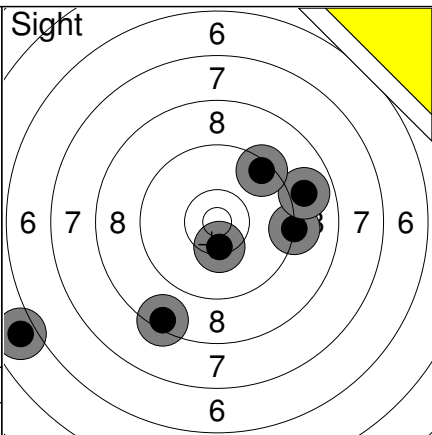

11:	5.9	↙
12:	9.2	→
13:	10.4x	↓
14:	8.9	↗
15:	9.4	↗
16:	8.4	↘
Series	49 (1x)	
	0 (0x)	

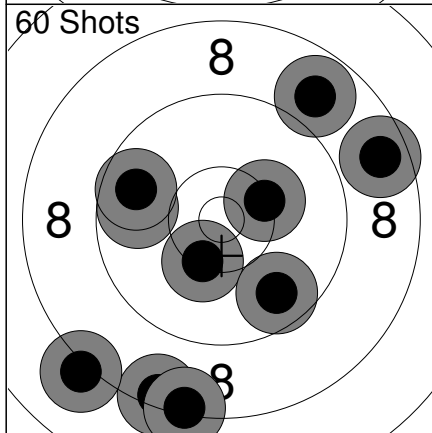

1:	10.3	↘
2:	8.8	↗
3:	8.6	→
4:	9.8	↙
5:	9.7	↙
6:	9.7	↘
7:	8.4	↘
8:	8.3	↘
9:	8.1	↙
10:	10.3	→
Series	87 (0x)	
	87 (0x)	

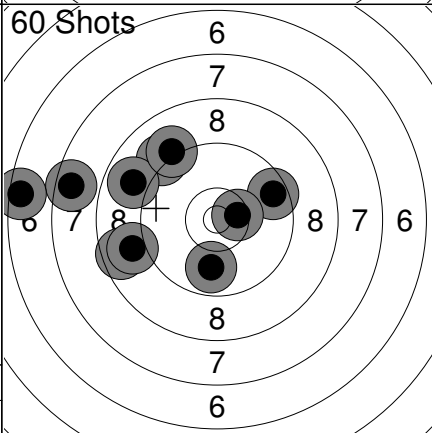

11:	9.1	↖
12:	9.6	→
13:	10.5x	→
14:	8.7	↙
15:	8.9	↙
16:	8.9	↖
17:	9.9	↓
18:	7.6	↙
19:	9.1	↗
20:	6.5	↙
Series	83 (1x)	
	170 (1x)	

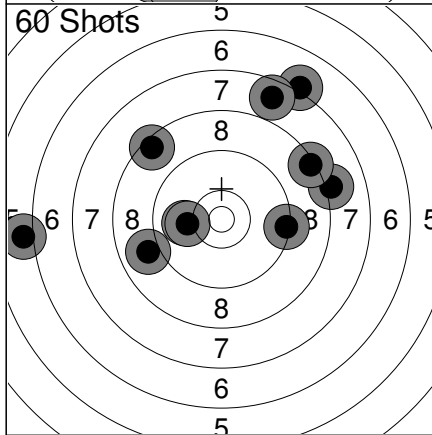

21:	6.0	↙
22:	8.9	↙
23:	10.0	↙
24:	10.1	↙
25:	8.5	↗
26:	7.1	↑
27:	7.7	↑
28:	8.1	→
29:	8.3	→
30:	9.3	→
Series	81 (0x)	
	251 (1x)	

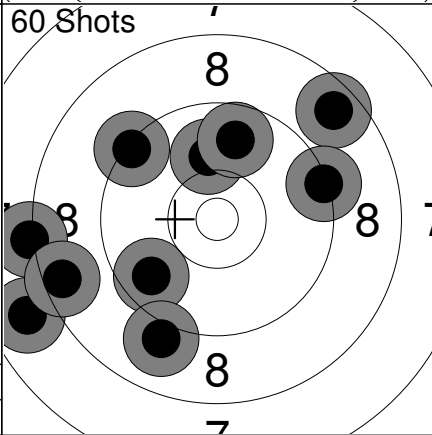

31:	7.8	↙
32:	8.2	↙
33:	10.0	↑
34:	8.5	↙
35:	9.3	↖
36:	9.7	↙
37:	9.7	↑
38:	8.6	↗
39:	9.3	→
40:	9.0	↘
Series	86 (0x)	
	337 (1x)	

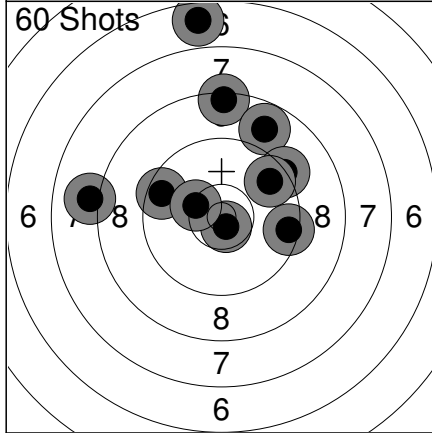

41:	8.4	↑
42:	8.0	↙
43:	6.6	↑
44:	9.5	↙
45:	8.8	↑
46:	10.7x	↘
47:	9.3	↗
48:	9.6	↗
49:	9.5	→
50:	10.3	↙
Series	86 (1x)	
	423 (2x)	

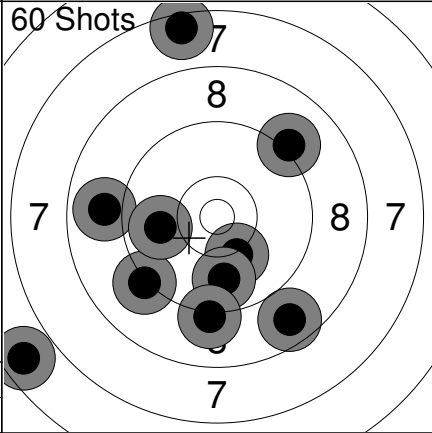

51:	7.5	↑
52:	8.9	↙
53:	8.7	↘
54:	9.2	↙
55:	10.2	↘
56:	9.9	↙
57:	9.8	↓
58:	6.6	↙
59:	9.1	↗
60:	9.2	↓
Series	84 (0x)	
	507 (2x)	

Relay **2** Lane **3** **KRUEGER Cameron**

2023 SFC Pistol Nationals SK JR MP

16.07.2023 23PN-AP-Q2 Alberta Handgun Association

Comment Signature

Sight 	1: 10.4x →	Sight 	11: 9.9 ↓
	2: 9.4 ←		12: 10.3 ↓
	3: 10.5x ↓		
	4: 10.3 ↓		
	5: 8.3 ↑		
	6: 9.1 ↓		
	7: 8.4 ↑		
	8: 9.3 ↓		
	9: 8.8 ↓		
	10: 8.5 ↑		
	Series 89 (2x)		Series 19 (0x)
	0 (0x)		0 (0x)

60 Shots 	1: 10.6x ←	60 Shots 	11: 9.5 ↓
	2: 10.2 →		12: 10.4x ↑
	3: 8.7 ↓		13: 10.4x ←
	4: 8.6 ↓		14: 9.7 ↓
	5: 9.8 ↑		15: 9.6 ↑
	6: 10.3 →		16: 8.7 ↑
	7: 8.8 ↑		17: 9.9 ↓
	8: 10.1 →		18: 9.6 ↓
	9: 10.2 ↓		19: 10.1 →
	10: 10.6x ←		20: 10.0 ↓
	Series 93 (2x)		Series 93 (2x)
	93 (2x)		186 (4x)

60 Shots 	21: 8.2 ↑	60 Shots 	31: 8.8 ↓
	22: 9.5 ↑		32: 8.4 ↓
	23: 10.4x ↑		33: 10.8x ←
	24: 10.3 ←		34: 9.8 ←
	25: 9.4 ←		35: 9.8 →
	26: 9.6 ↓		36: 8.9 →
	27: 9.8 →		37: 10.2 ←
	28: 10.3 ↑		38: 9.5 ↑
	29: 10.4x ↑		39: 10.0 ←
	30: 10.2 →		40: 9.9 ←
	Series 94 (2x)		Series 90 (1x)
	280 (6x)		370 (7x)

60 Shots 	41: 8.8 ↑	60 Shots 	51: 8.8 ↑
	42: 7.8 ↓		52: 8.6 →
	43: 10.1 ↑		53: 10.4x →
	44: 9.1 ↑		54: 8.3 ↑
	45: 10.2 ↓		55: 10.3 ←
	46: 8.3 ↑		56: 8.0 ↓
	47: 10.6x ↑		57: 10.4x →
	48: 9.5 ↑		58: 9.1 ↓
	49: 10.1 →		59: 9.1 ↑
	50: 9.1 ↑		60: 9.8 ←
	Series 90 (1x)		Series 89 (2x)
	460 (8x)		549 (10x)



Comment	Signature		
---------	-----------	--	--

<p>Sight</p> <p>5 6 7 8 6 7 8 7 6 8 7 6</p> <p>1: 7.5 ↓ 2: 7.7 ↗ 3: 8.5 ↗ 4: 8.0 ↗ 5: 9.4 ↗ 6: 9.0 ↖ 7: 9.6 ↗ 8: 5.9 ↗ 9: 5.3 ↗ 10: 5.5 ↗</p> <p>Series 72 (0x) 0 (0x)</p>	<p>Sight</p> <p>5 6 7 8 5 6 7 8 8 7 6 5 8 7 6 5</p> <p>11: 6.7 ↗ 12: 5.2 ↑ 13: 8.1 ↗ 14: 9.3 ↑ 15: 7.4 ↑ 16: 5.3 ↖ 17: 7.0 ↗ 18: 7.7 ↖ 19: 7.6 → 20: 9.8 ↖</p> <p>Series 70 (0x) 0 (0x)</p>
--	---

<p>Sight</p> <p>5 7 8 7 7 8 8 7 8 7</p> <p>21: 9.7 ↑ 22: 8.5 ↑ 23: 6.9 ↑</p> <p>Series 23 (0x) 0 (0x)</p>	<p>60 Shots</p> <p>4 5 6 7 5 6 7 8 8 7 6 5 4 8 7 6 5 4</p> <p>1: 5.3 ↑ 2: 8.4 ↑ 3: 7.7 ↖ 4: 3.9 ↑ 5: 6.9 ↑ 6: 6.8 ↑ 7: 8.3 ↖ 8: 5.8 ↑ 9: 8.5 ← 10: 4.6 ↑</p> <p>Series 60 (0x) 60 (0x)</p>
---	--

<p>60 Shots</p> <p>3 4 5 6 7 4 5 6 7 8 8 7 6 5 4 8 7 6 5 4 3</p> <p>11: 5.9 ↑ 12: 6.4 ↑ 13: 3.5 ↑ 14: 7.9 ↖ 15: 8.2 ↗ 16: 6.2 ↗ 17: 6.3 ↗ 18: 7.0 ↗ 19: 7.3 ↗ 20: 9.1 ↑</p> <p>Series 64 (0x) 124 (0x)</p>	<p>60 Shots</p> <p>3 6 7 8 6 7 8 8 7 6 8 7 6 5</p> <p>21: 9.9 ↓ 22: 7.2 ↖ 23: 8.4 ↗ 24: 6.6 ↑ 25: 7.5 ↗ 26: 7.4 ↑ 27: 7.8 ↑ 28: 6.2 ↖ 29: 9.2 ↑ 30: 9.5 ←</p> <p>Series 75 (0x) 199 (0x)</p>
--	--



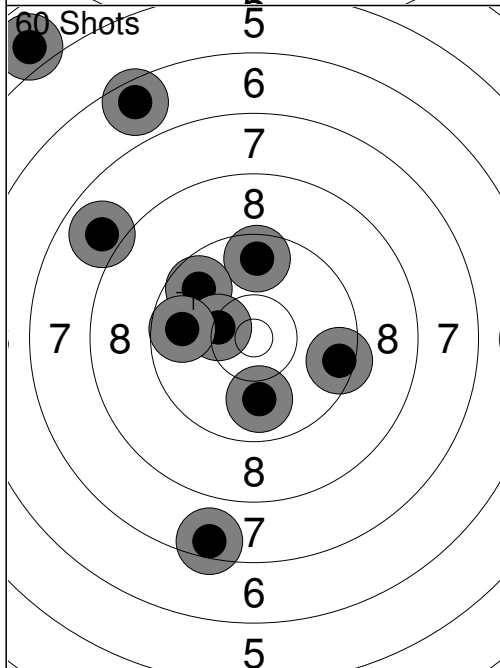
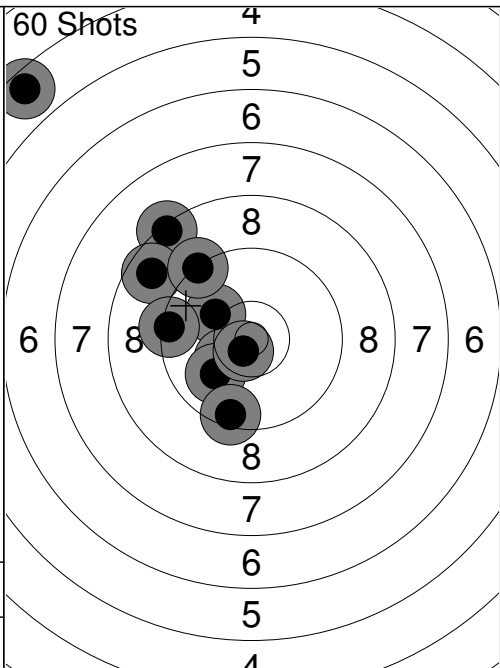
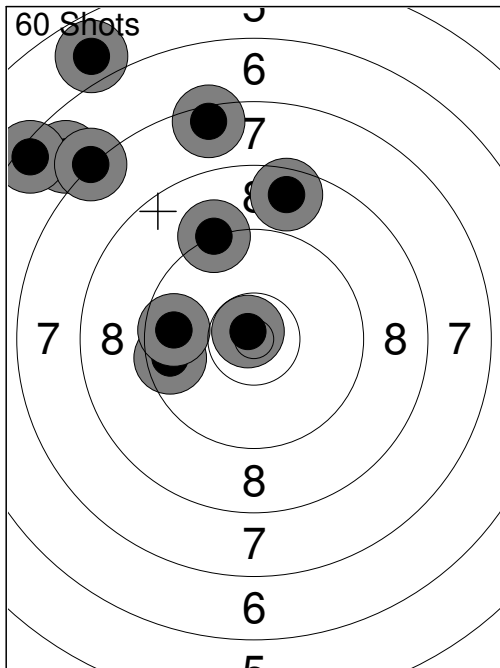

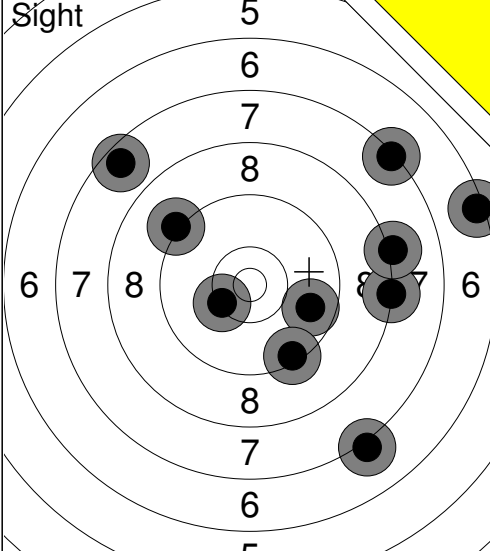
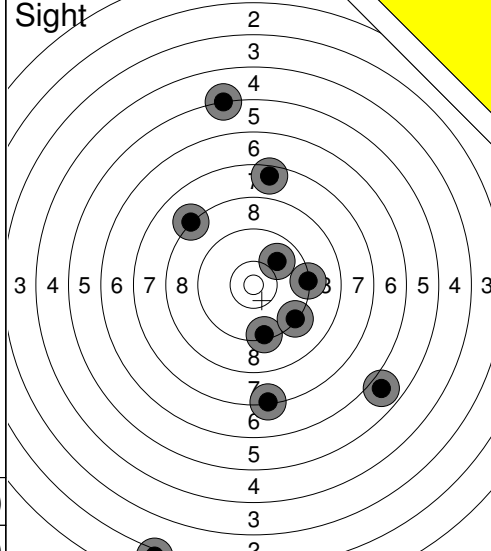
<p>Sight</p> 	<p>1: 7.1 ↓ 2: 8.2 → 3: 8.1 → 4: 9.7 → 5: 7.3 ↗ 6: 9.1 ↗ 7: 7.5 ↗ 8: 10.3 ← 9: 9.4 ↓ 10: 6.4 →</p> <p>Series 80 (0x) 0 (0x)</p>	<p>Sight</p> 	<p>11: 9.4 ↓ 12: 7.6 ↑ 13: 2.0 ↓ 14: 9.3 → 15: 5.9 ↘ 16: 9.9 ↗ 17: 7.3 ↓ 18: 5.2 ↑ 19: 8.2 ↗ 20: 9.3 ↘</p> <p>Series 70 (0x) 0 (0x)</p>
---	---	---	---

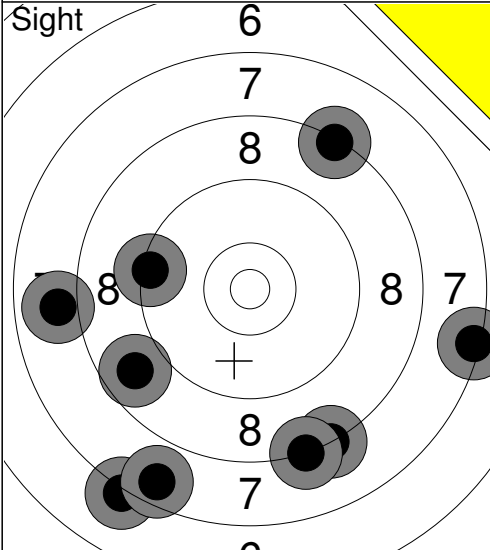
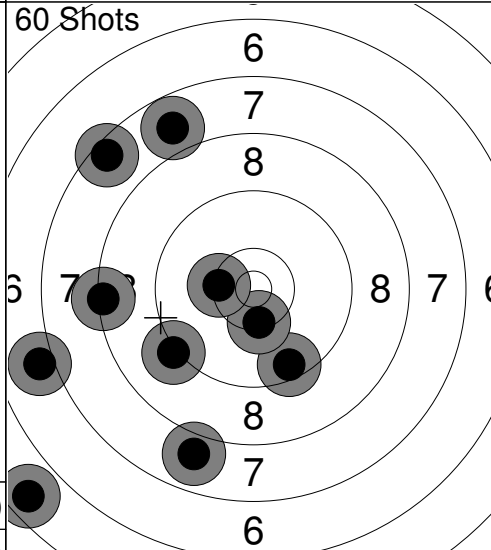
<p>Sight</p> 	<p>21: 7.2 ↓ 22: 7.3 → 23: 8.3 ↑ 24: 7.6 ↓ 25: 9.4 ← 26: 8.2 ↓ 27: 7.9 ← 28: 8.2 ↓ 29: 8.7 ←</p> <p>Series 69 (0x) 0 (0x)</p>	<p>60 Shots</p> 	<p>1: 9.5 ↓ 2: 7.9 ↓ 3: 7.5 ↗ 4: 7.8 ↑ 5: 10.4x ↓ 6: 5.6 ← 7: 10.3 ← 8: 8.3 ← 9: 9.2 ← 10: 7.0 ←</p> <p>Series 79 (1x) 79 (1x)</p>
--	---	---	--

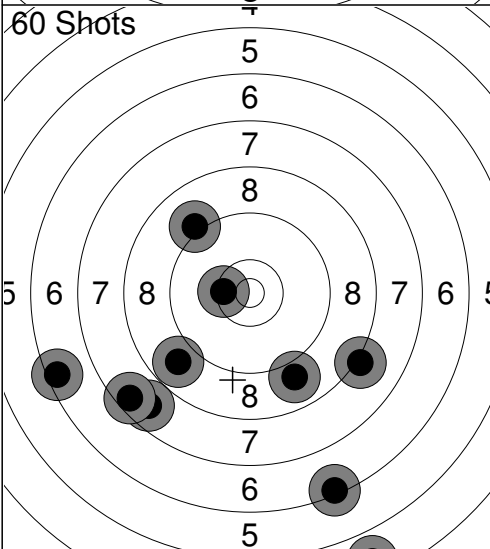
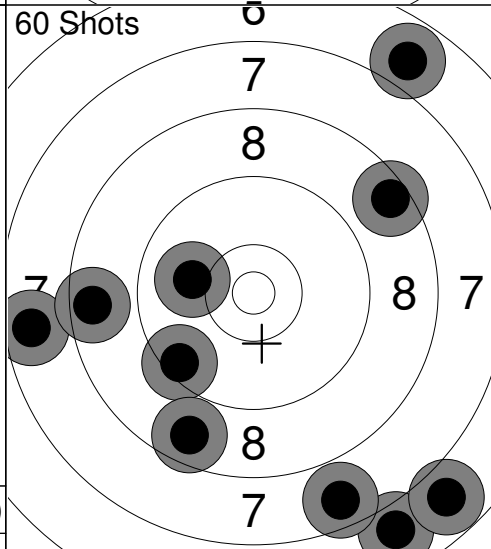
<p>60 Shots</p> 	<p>11: 6.3 ↓ 12: 4.6 ↓ 13: 9.1 ↗ 14: 8.1 → 15: 7.7 ↓ 16: 8.9 ↓ 17: 7.5 ← 18: 6.4 ← 19: 8.8 ↓ 20: 10.4x ←</p> <p>Series 73 (1x) 152 (2x)</p>	<p>60 Shots</p> 	<p>21: 10.0 ← 22: 6.9 ↓ 23: 7.6 ← 24: 6.8 ↓ 25: 7.6 ↓ 26: 9.5 ← 27: 8.7 ↓ 28: 8.5 ↗ 29: 6.8 ↑ 30: 8.6 ←</p> <p>Series 75 (0x) 227 (2x)</p>
--	---	--	--



Relay **2** Lane **6** **LUO Max fangzhi**

2023 SFC Pistol Nationals BC SJ MP

16.07.2023 23PN-AP-Q2 Alberta Handgun Association

Comment Signature

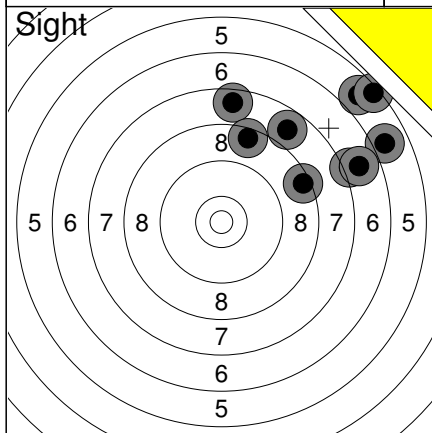

1:	8.4	→
2:	5.9	→
3:	7.6	↑
4:	3.8	→
5:	7.1	→
6:	5.7	↗
7:	6.8	→
8:	8.5	↑
9:	5.4	↗
10:	7.8	↗
Series	61 (0x)	
	0 (0x)	

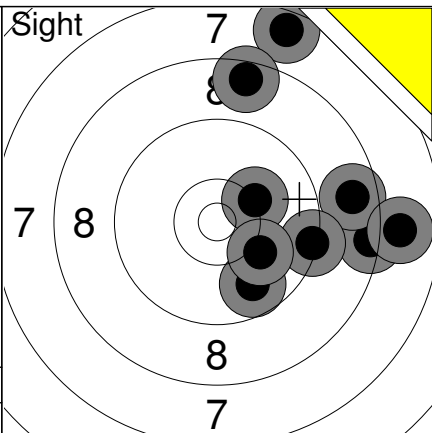

11:	7.5	↑
12:	8.4	→
13:	8.5	↑
14:	8.7	→
15:	9.8	↓
16:	9.3	→
17:	7.9	→
18:	10.2	↗
19:	10.1	↘
Series	76 (0x)	
	0 (0x)	

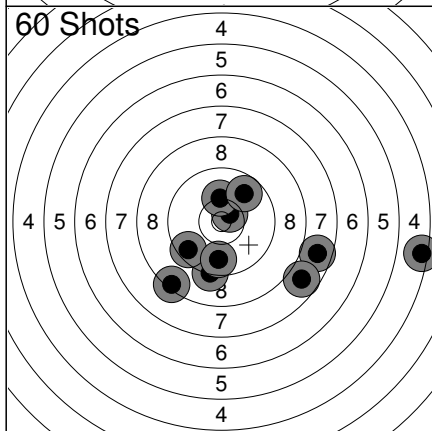

1:	9.3	↓
2:	7.7	→
3:	7.8	↘
4:	9.5	←
5:	9.7	↓
6:	10.6x	↗
7:	4.4	→
8:	10.2	↑
9:	8.4	↘
10:	9.8	↗
Series	82 (1x)	
	82 (1x)	

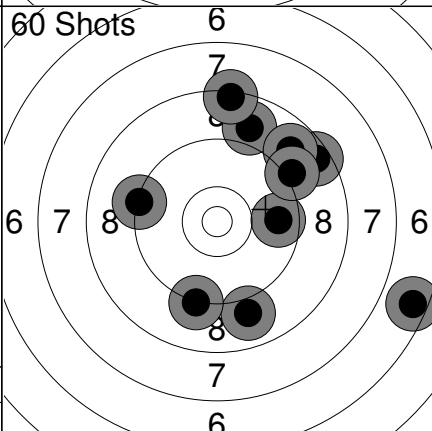

11:	9.3	←
12:	8.9	↑
13:	8.3	↑
14:	8.5	↗
15:	8.8	↗
16:	8.9	↓
17:	9.7	→
18:	9.1	↗
19:	6.5	→
20:	9.2	↓
Series	82 (0x)	
	164 (1x)	

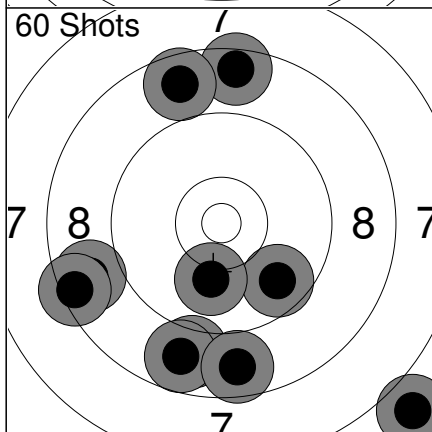

21:	8.5	↑
22:	8.7	←
23:	8.7	↑
24:	9.7	↘
25:	10.1	↓
26:	8.9	↓
27:	8.8	↓
28:	8.4	←
29:	6.8	↘
30:	8.7	↓
Series	81 (0x)	
	245 (1x)	

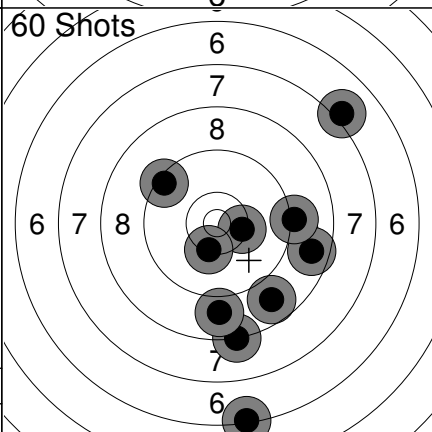

31:	8.6	→
32:	8.2	↓
33:	9.4	↗
34:	6.3	↓
35:	9.1	→
36:	8.7	↓
37:	10.3	→
38:	8.9	↓
39:	10.3	↓
40:	7.1	↗
Series	83 (0x)	
	328 (1x)	

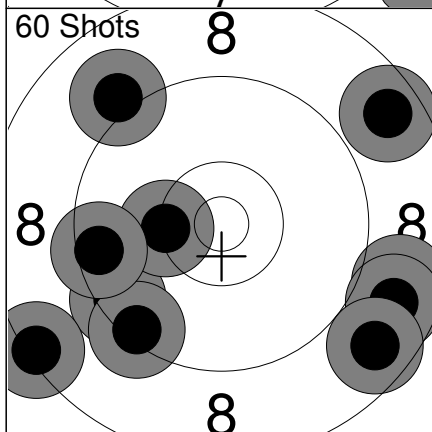

41:	9.0	↗
42:	8.6	↗
43:	9.5	←
44:	9.4	←
45:	10.3	←
46:	8.8	→
47:	8.3	←
48:	9.5	←
49:	8.7	→
50:	8.7	↘
Series	86 (0x)	
	414 (1x)	

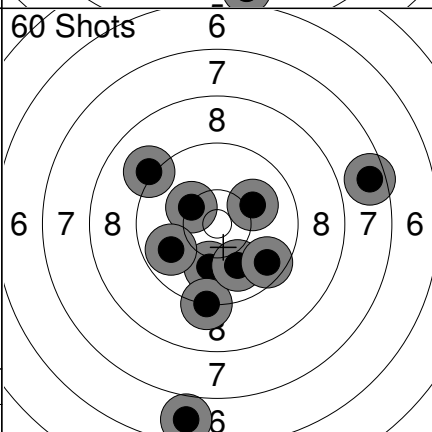

51:	10.3	↖
52:	10.0	↓
53:	9.2	↓
54:	10.0	↓
55:	9.1	↗
56:	9.8	←
57:	10.1	↗
58:	9.6	↘
59:	7.6	→
60:	6.7	↓
Series	89 (0x)	
	503 (1x)	

Relay **2** Lane **7** **PADDA Harvir singh**

2023 SFC Pistol Nationals BC SJ MP

16.07.2023 23PN-AP-Q2 Alberta Handgun Association

Comment Signature

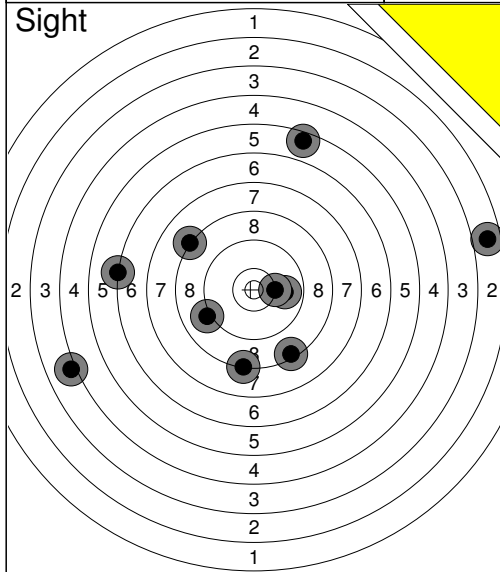

1:	6.2	←
2:	8.3	↓
3:	5.5	↑
4:	8.4	↓
5:	4.1	←
6:	9.9	→
7:	2.7	→
8:	8.2	↖
9:	10.2	→
10:	9.1	←
Series	69 (0x)	
	0 (0x)	

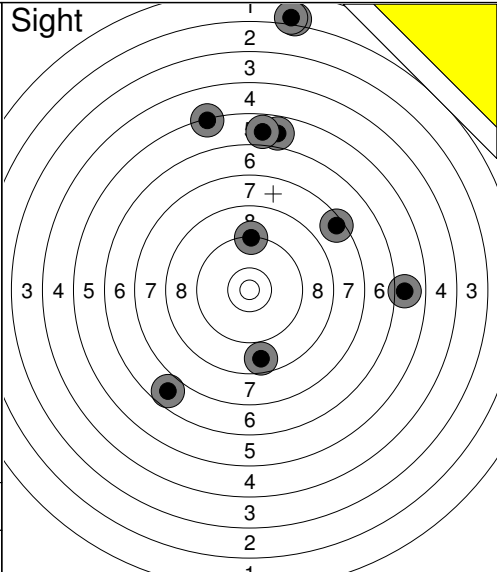

11:	7.4	↗
12:	5.3	↑
13:	5.8	↑
14:	5.9	→
15:	8.7	↓
16:	2.0	↑
17:	5.8	↑
18:	9.3	↑
19:	6.7	↙
20:	2.0	↑
Series	54 (0x)	
	0 (0x)	

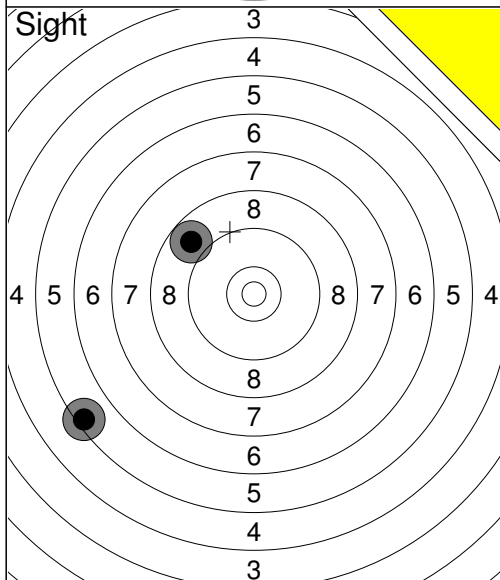

21:	5.4	↙
22:	2.8	↗
23:	8.8	↖
Series	15 (0x)	
	0 (0x)	

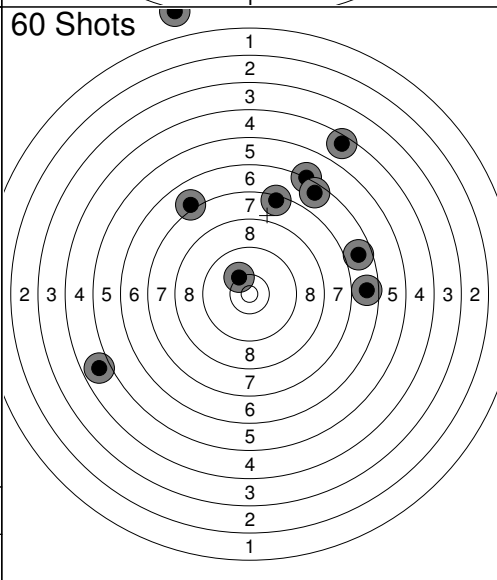

1:	6.2	↗
2:	7.4	↑
3:	7.1	↖
4:	6.7	→
5:	6.6	↗
6:	4.5	↗
7:	10.2	↖
8:	0.0	↑
9:	4.8	←
10:	6.7	→
Series	56 (0x)	
	56 (0x)	

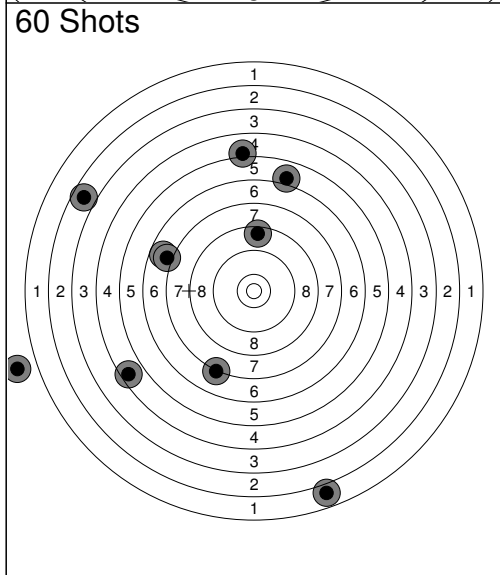

11:	2.7	↖
12:	6.0	↑
13:	8.5	↑
14:	4.6	←
15:	7.2	↓
16:	6.8	←
17:	7.0	←
18:	1.8	↓
19:	0.0	←
20:	5.1	↑
Series	46 (0x)	
	102 (0x)	

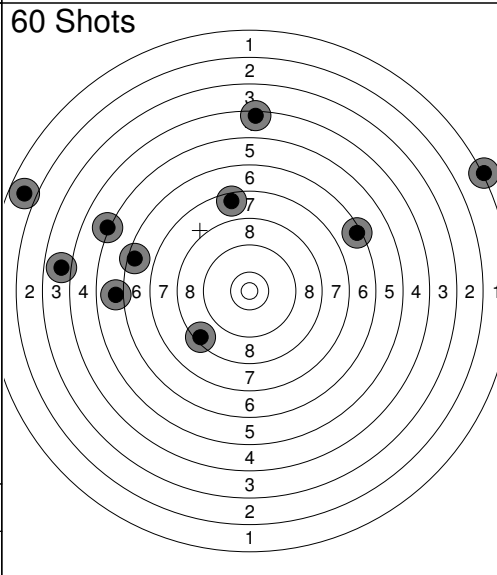

21:	4.4	↑
22:	6.5	←
23:	1.2	↗
24:	6.0	←
25:	8.4	↙
26:	5.1	↖
27:	7.5	↑
28:	1.8	←
29:	3.9	←
30:	6.4	↗
Series	47 (0x)	
	149 (0x)	

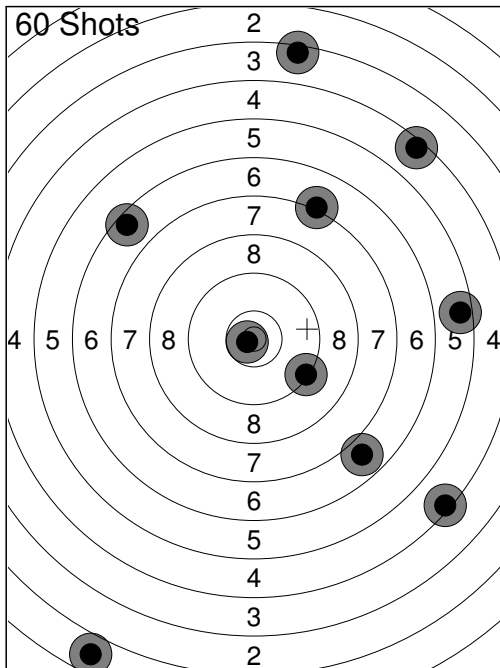

31:	7.2	↗
32:	6.5	↗
33:	6.8	↘
34:	4.4	↘
35:	9.3	↘
36:	10.8x	←
37:	5.5	→
38:	3.4	↑
39:	4.4	↗
40:	1.7	↘
Series	55 ( 1x)	
	204 ( 1x)	

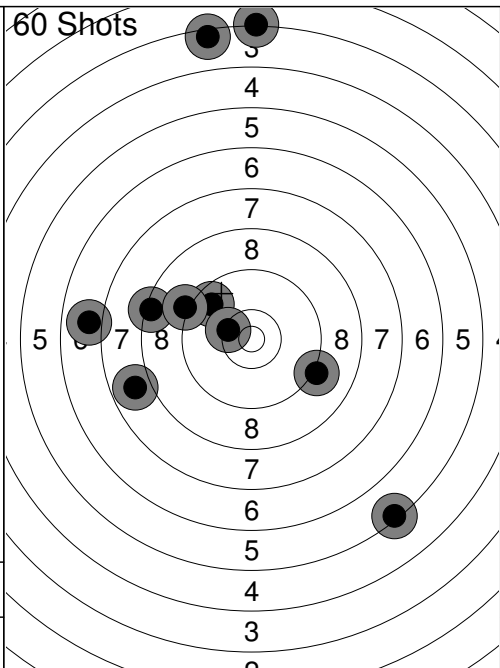

41:	8.4	←
42:	9.6	↗
43:	6.9	←
44:	3.2	↑
45:	9.1	↘
46:	5.3	↘
47:	7.8	←
48:	10.3	←
49:	9.1	←
50:	3.4	↑
Series	69 ( 0x)	
	273 ( 1x)	

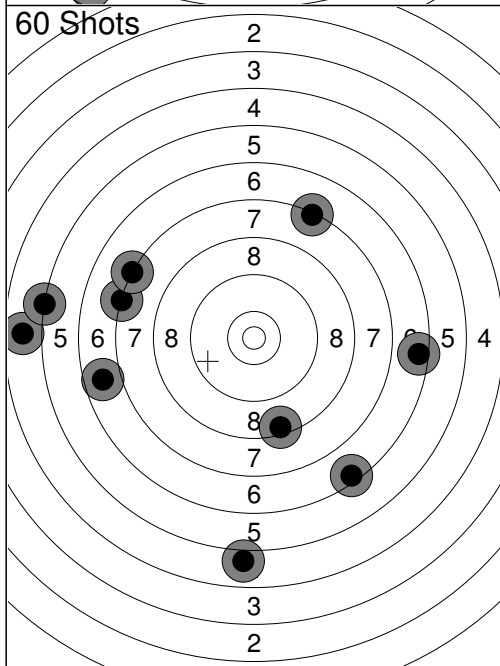

51:	7.3	↗
52:	4.7	←
53:	6.7	←
54:	5.2	←
55:	8.4	↘
56:	6.5	→
57:	6.4	↘
58:	7.2	←
59:	4.9	↓
60:	7.2	↖
Series	60 ( 0x)	
	333 ( 1x)	

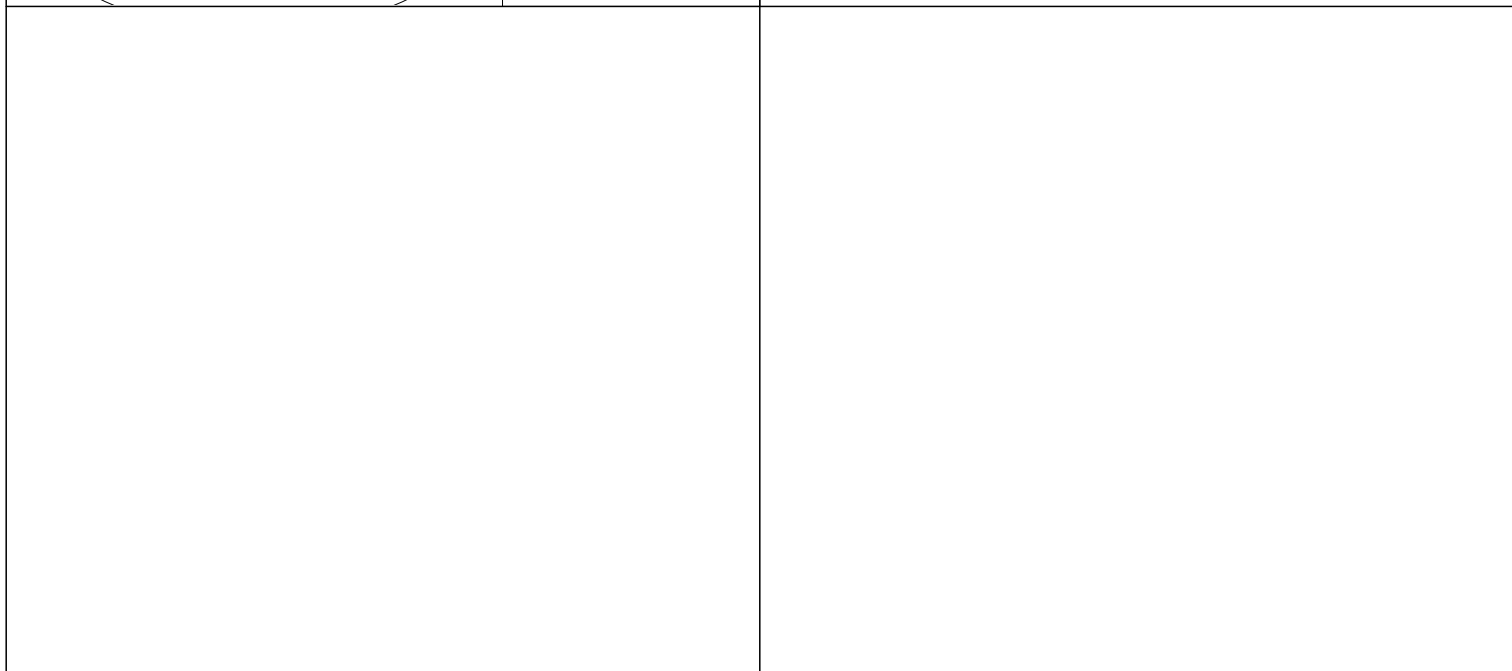



Relay **2** Lane **8** **WANG Eddie shihan**

2023 SFC Pistol Nationals BC SJ MP

16.07.2023 23PN-AP-Q2 Alberta Handgun Association

Comment Signature

	1: 9.7 ↖		1: 9.8 ↑
	2: 4.6 ↗		2: 9.2 ↗
	3: 9.0 ↗		3: 8.9 →
	4: 8.2 ↗		4: 10.3 ↖
	5: 8.9 ↗		5: 10.1 ↘
	6: 10.1 ↖		6: 8.3 ↘
	7: 8.6 ↗		7: 8.8 ↘
	8: 10.3 →		8: 9.6 ↖
	9: 7.7 ↓		9: 9.8 ↑
	10: 6.1 →		10: 8.8 ↗
Series	79 (0x)	Series	88 (0x)
	0 (0x)		88 (0x)

	11: 7.9 ↗		21: 7.5 ↑
	12: 10.5x ↓		22: 9.0 ↖
	13: 8.8 ↓		23: 10.6x →
	14: 8.6 →		24: 8.9 ↑
	15: 8.8 →		25: 9.2 ↗
	16: 9.5 ↗		26: 5.8 →
	17: 9.7 →		27: 8.6 ↑
	18: 9.5 ↗		28: 8.3 ↘
	19: 9.3 →		29: 8.7 ↘
	20: 8.9 →		30: 9.0 ↗
Series	85 (1x)	Series	81 (1x)
	173 (1x)		254 (2x)

	31: 10.2 ↓		41: 10.6x ↘
	32: 6.8 →		42: 10.1 ↗
	33: 9.1 ↓		43: 7.4 ↗
	34: 8.4 ↑		44: 9.8 ↖
	35: 8.3 ↗		45: 8.6 →
	36: 7.9 ↗		46: 9.2 ↘
	37: 9.2 ↖		47: 8.5 ↗
	38: 10.4x ↑		48: 9.0 →
	39: 9.1 ↗		49: 9.4 ↖
	40: 10.5x ↓		50: 9.9 ↖
Series	86 (2x)	Series	88 (1x)
	340 (4x)		428 (5x)

	51: 8.8 →		
	52: 8.2 →		
	53: 10.0 ↗		
	54: 9.2 ↖		
	55: 9.9 ↗		
	56: 9.3 ↗		
	57: 8.9 ↓		
	58: 9.3 ↖		
	59: 10.4x ↓		
	60: 9.0 ↑		
Series	89 (1x)		
	517 (6x)		

Comment	Signature
---------	-----------

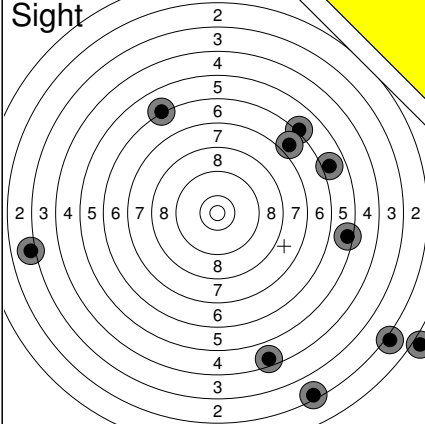
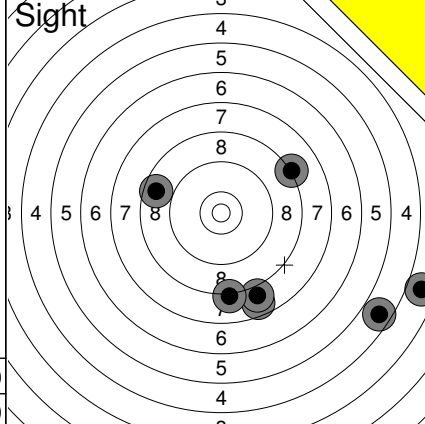
Sight	Sight		
		1: 6.1 ↗ 2: 6.2 ↗ 3: 6.9 ↗ 4: 2.1 ↘ 5: 4.5 ↘ 6: 5.9 → 7: 3.1 ← 8: 5.5 → 9: 2.4 ↘ 10: 1.0 ↘	11: 7.7 ↓ 12: 8.2 → 13: 4.6 ↘ 14: 7.9 ↘ 15: 8.1 ↓ 16: 8.6 ← 17: 3.7 →
Series	40 (0x)	Series	45 (0x)
	0 (0x)		0 (0x)
60 Shots	60 Shots	1: 10.5x ↘ 2: 8.8 ↗ 3: 5.7 → 4: 7.8 ↘ 5: 8.8 ↘ 6: 5.0 ↘ 7: 4.1 ↘ 8: 10.2 ← 9: 5.6 ↘ 10: 6.1 ↘	11: 7.8 → 12: 10.2 ← 13: 7.7 ↘ 14: 6.6 ↘ 15: 7.8 ← 16: 1.0 ↓ 17: 8.3 ↓ 18: 8.3 → 19: 8.9 ↗ 20: 0.0 →
Series	68 (1x)	Series	62 (0x)
	68 (1x)		130 (1x)
60 Shots	60 Shots	21: 7.0 ← 22: 5.8 ↘ 23: 4.9 ↑ 24: 5.9 ↘ 25: 7.0 ↑ 26: 6.4 ↗ 27: 4.8 ↘ 28: 5.0 → 29: 9.0 ↗ 30: 8.2 ↗	31: 7.6 ↘ 32: 6.6 ↓ 33: 10.1 ↘ 34: 8.5 ↗ 35: 8.9 ← 36: 3.8 → 37: 6.6 ← 38: 8.1 ↓ 39: 7.2 ↓ 40: 7.5 →
Series	60 (0x)	Series	70 (0x)
	190 (1x)		260 (1x)
60 Shots	60 Shots	41: 9.1 → 42: 9.6 ↘ 43: 8.5 ← 44: 7.4 → 45: 4.8 ↘ 46: 7.7 ↗ 47: 9.6 ↗ 48: 6.6 ↑ 49: 4.2 ↘ 50: 7.7 ↓	51: 6.9 ↓ 52: 4.9 ↘ 53: 6.2 ↗ 54: 5.1 → 55: 8.8 ↗ 56: 5.0 ↓ 57: 8.4 ↗ 58: 6.7 ↗ 59: 8.6 ↘ 60: 3.2 ↓
Series	70 (0x)	Series	59 (0x)
	330 (1x)		389 (1x)

Relay <b>2</b>	Lane <b>10</b>	<b>LI Ethan</b>
-------------------	-------------------	-----------------

2023 SFC Pistol Nationals	MA	IJ	MP
---------------------------	----	----	----

16.07.2023	23PN-AP-Q2	Alberta Handgun Association
------------	------------	-----------------------------

Comment	Signature
---------	-----------

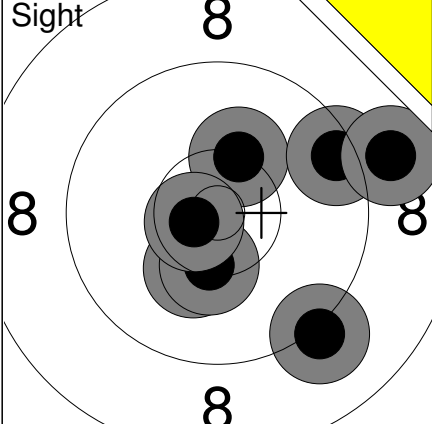
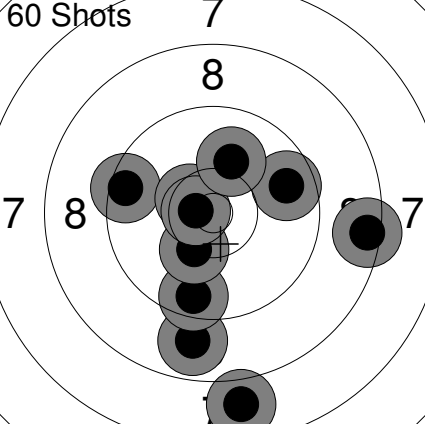
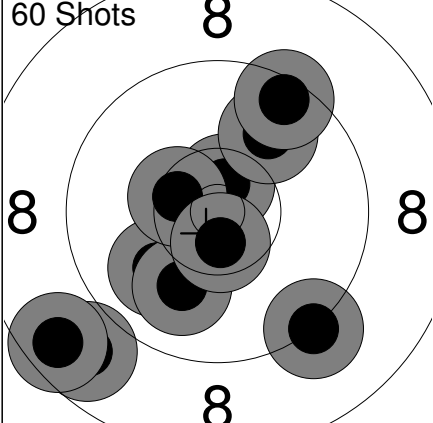
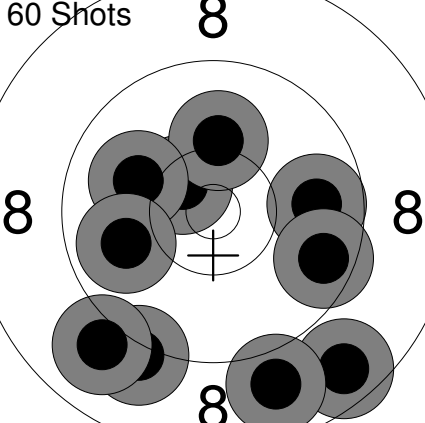
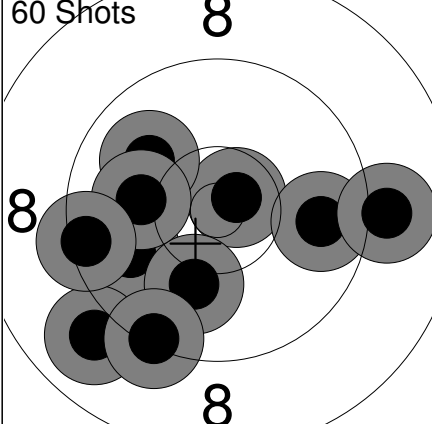
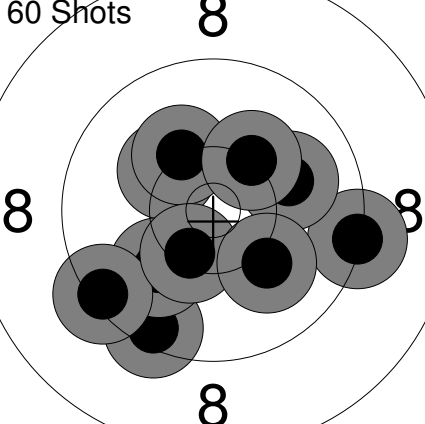
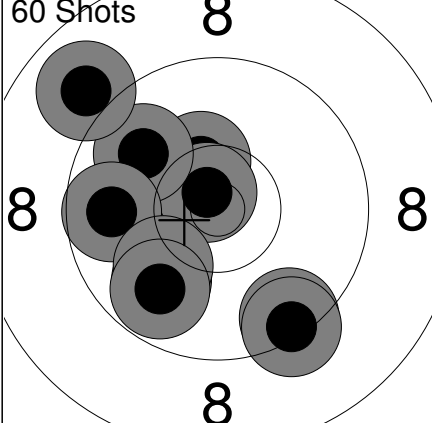
<p>Sight</p> 	<p>1: 10.3 ↗ 2: 9.2 ↘ 3: 9.5 → 4: 10.3 ↘ 5: 10.3 ↘ 6: 10.7x ← 7: 8.9 →</p> <p>Series 66 ( 1x) 0 ( 0x)</p>	<p>60 Shots 7</p> 	<p>1: 9.7 → 2: 8.4 → 3: 7.8 ↓ 4: 8.9 ↓ 5: 9.6 ↓ 6: 10.3 ↘ 7: 9.5 ← 8: 10.5x ↗ 9: 10.7x ← 10: 10.1 ↗</p> <p>Series 90 ( 2x) 90 ( 2x)</p>
<p>60 Shots</p> 	<p>11: 10.6x ↗ 12: 9.2 ↘ 13: 10.0 ↘ 14: 8.8 ↘ 15: 9.9 ↗ 16: 10.0 ↘ 17: 10.5x ↗ 18: 8.6 ↘ 19: 10.6x ↘ 20: 9.5 ↗</p> <p>Series 93 ( 3x) 183 ( 5x)</p>	<p>60 Shots 8</p> 	<p>21: 10.5x ↗ 22: 9.8 → 23: 9.1 ↘ 24: 10.1 ↗ 25: 10.0 ↗ 26: 8.6 ↘ 27: 9.9 ← 28: 9.6 → 29: 9.0 ↘ 30: 8.9 ↘</p> <p>Series 91 ( 1x) 274 ( 6x)</p>
<p>60 Shots</p> 	<p>31: 9.8 ← 32: 10.7x → 33: 9.0 ↘ 34: 10.1 ↘ 35: 9.8 → 36: 9.0 → 37: 10.0 ↗ 38: 10.1 ← 39: 9.3 ↘ 40: 9.4 ←</p> <p>Series 94 ( 1x) 368 ( 7x)</p>	<p>60 Shots</p> 	<p>41: 10.3 ↗ 42: 9.3 → 43: 9.4 ↘ 44: 10.1 ↘ 45: 9.4 ↗ 46: 10.2 ↗ 47: 10.4x ↘ 48: 10.0 → 49: 10.1 ↘ 50: 10.2 ↗</p> <p>Series 97 ( 1x) 465 ( 8x)</p>
<p>60 Shots</p> 	<p>51: 10.4x ↗ 52: 9.5 ↘ 53: 10.7x ↗ 54: 9.9 ↗ 55: 9.7 ← 56: 8.9 ↗ 57: 9.4 ↘ 58: 9.9 ↘ 59: 10.1 ↘ 60: 9.8 ↘</p> <p>Series 92 ( 2x) 557 ( 10x)</p>		

Relay **2** Lane **11** **VASILEVA Yanka**

2023 SFC Pistol Nationals QC MA WP

16.07.2023 23PN-AP-Q2 Alberta Handgun Association

Comment Signature

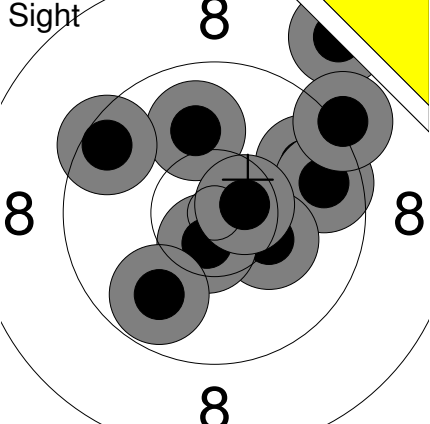
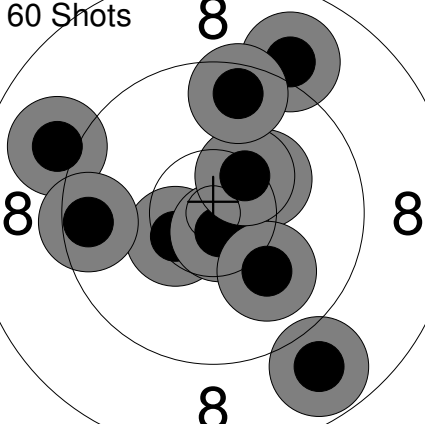
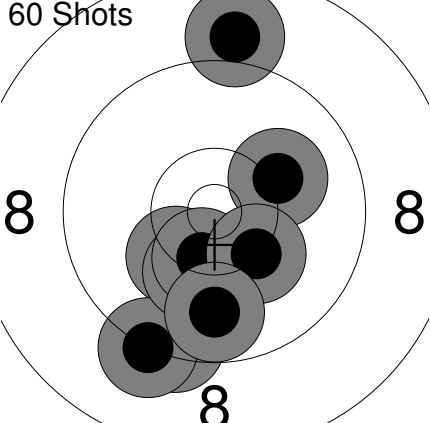
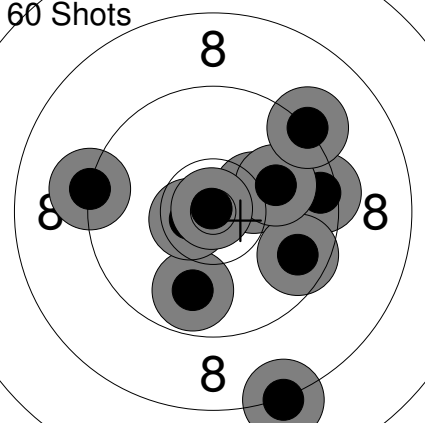
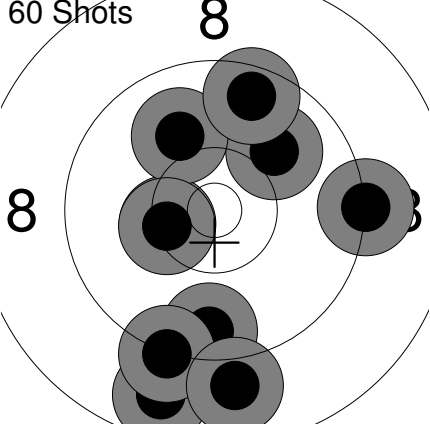
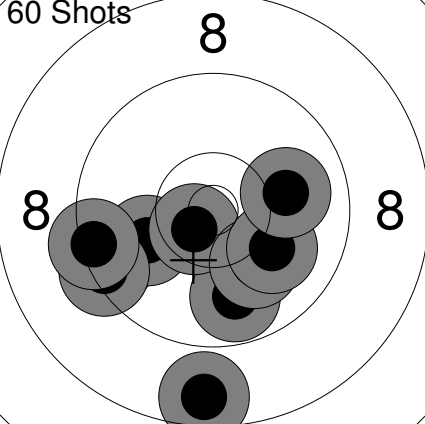
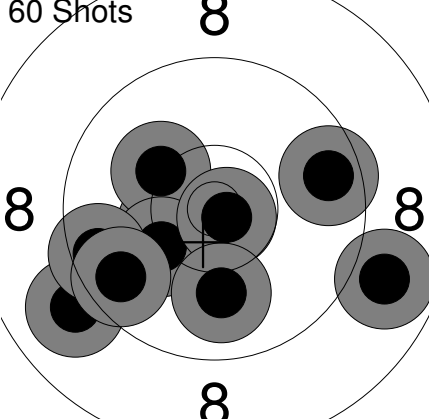
Sight 	1: 9.8 → 2: 9.7 → 3: 10.0 ↑ 4: 10.3 → 5: 10.6x ↓ 6: 9.8 ↓ 7: 8.5 ↑ 8: 9.2 → 9: 9.5 ← 10: 10.6x →	60 Shots 	1: 10.4x ↙ 2: 10.3 ↗ 3: 10.7x ↓ 4: 9.0 ↑ 5: 10.1 ↓ 6: 10.4x ↗ 7: 9.6 ↑ 8: 8.8 ↓ 9: 9.0 ← 10: 9.5 ←
	Series 93 (2x) 0 (0x)		Series 94 (3x) 94 (3x)
60 Shots 	11: 8.9 ↑ 12: 9.4 ↓ 13: 10.1 → 14: 10.3 ← 15: 9.2 ↓ 16: 10.2 ↓ 17: 10.2 ↓ 18: 10.4x ↓ 19: 10.3 ↓ 20: 9.8 ↓	60 Shots 	21: 9.8 ↓ 22: 9.2 ← 23: 9.5 → 24: 10.3 ↗ 25: 9.7 → 26: 10.6x ← 27: 10.0 → 28: 8.2 ↓ 29: 9.2 ↗ 30: 10.9x ↗
	Series 95 (1x) 189 (4x)		Series 93 (2x) 282 (6x)
60 Shots 	31: 10.4x ← 32: 10.0 ↗ 33: 8.7 ↓ 34: 9.6 ↓ 35: 10.0 ↑ 36: 10.4x ← 37: 9.2 ↓ 38: 9.6 ↑ 39: 9.2 → 40: 8.9 ↓	60 Shots 	41: 9.8 ↓ 42: 9.5 ← 43: 10.0 ← 44: 9.4 ← 45: 10.6x ↙ 46: 10.1 ↓ 47: 8.6 ↓ 48: 10.1 → 49: 9.4 ← 50: 10.0 →
	Series 92 (2x) 374 (8x)		Series 94 (1x) 468 (9x)
60 Shots 	51: 10.4x ← 52: 10.2 ↗ 53: 10.2 ← 54: 9.6 → 55: 9.0 ← 56: 10.8x ↓ 57: 10.0 ↓ 58: 9.5 ← 59: 8.9 → 60: 9.6 ↙		
	Series 94 (2x) 562 (11x)		

Comment	Signature		
---------	-----------	--	--

<p>Sight</p>	<table border="1" style="width:100%; border-collapse: collapse;"> <tr><td>1:</td><td>10.0</td><td>↗</td></tr> <tr><td>2:</td><td>9.7</td><td>↗</td></tr> <tr><td>3:</td><td>7.3</td><td>↘</td></tr> <tr><td>4:</td><td>8.4</td><td>↘</td></tr> <tr><td>5:</td><td>8.9</td><td>↓</td></tr> <tr><td>6:</td><td>10.1</td><td>↑</td></tr> <tr><td>7:</td><td>10.3</td><td>↑</td></tr> <tr><td>8:</td><td>8.6</td><td>↗</td></tr> <tr><td>9:</td><td>10.4x</td><td>↙</td></tr> <tr><td>10:</td><td>8.8</td><td>↑</td></tr> <tr><td colspan="2">Series</td><td>88 (1x)</td></tr> <tr><td colspan="2"></td><td>0 (0x)</td></tr> </table>	1:	10.0	↗	2:	9.7	↗	3:	7.3	↘	4:	8.4	↘	5:	8.9	↓	6:	10.1	↑	7:	10.3	↑	8:	8.6	↗	9:	10.4x	↙	10:	8.8	↑	Series		88 (1x)			0 (0x)	<p>Sight</p>	<table border="1" style="width:100%; border-collapse: collapse;"> <tr><td>11:</td><td>9.1</td><td>↗</td></tr> <tr><td colspan="2">Series</td><td>9 (0x)</td></tr> <tr><td colspan="2"></td><td>0 (0x)</td></tr> </table>	11:	9.1	↗	Series		9 (0x)			0 (0x)																											
1:	10.0	↗																																																																									
2:	9.7	↗																																																																									
3:	7.3	↘																																																																									
4:	8.4	↘																																																																									
5:	8.9	↓																																																																									
6:	10.1	↑																																																																									
7:	10.3	↑																																																																									
8:	8.6	↗																																																																									
9:	10.4x	↙																																																																									
10:	8.8	↑																																																																									
Series		88 (1x)																																																																									
		0 (0x)																																																																									
11:	9.1	↗																																																																									
Series		9 (0x)																																																																									
		0 (0x)																																																																									
<p>60 Shots</p>	<table border="1" style="width:100%; border-collapse: collapse;"> <tr><td>1:</td><td>7.3</td><td>↗</td></tr> <tr><td>2:</td><td>10.5x</td><td>↑</td></tr> <tr><td>3:</td><td>8.5</td><td>←</td></tr> <tr><td>4:</td><td>9.8</td><td>↘</td></tr> <tr><td>5:</td><td>9.9</td><td>↑</td></tr> <tr><td>6:</td><td>10.0</td><td>←</td></tr> <tr><td>7:</td><td>9.7</td><td>↘</td></tr> <tr><td>8:</td><td>9.6</td><td>↗</td></tr> <tr><td>9:</td><td>8.6</td><td>↗</td></tr> <tr><td>10:</td><td>9.3</td><td>↗</td></tr> <tr><td colspan="2">Series</td><td>88 (1x)</td></tr> <tr><td colspan="2"></td><td>88 (1x)</td></tr> </table>	1:	7.3	↗	2:	10.5x	↑	3:	8.5	←	4:	9.8	↘	5:	9.9	↑	6:	10.0	←	7:	9.7	↘	8:	9.6	↗	9:	8.6	↗	10:	9.3	↗	Series		88 (1x)			88 (1x)	<p>60 Shots</p>	<table border="1" style="width:100%; border-collapse: collapse;"> <tr><td>11:</td><td>8.4</td><td>↗</td></tr> <tr><td>12:</td><td>8.9</td><td>↑</td></tr> <tr><td>13:</td><td>9.4</td><td>↑</td></tr> <tr><td>14:</td><td>9.4</td><td>↘</td></tr> <tr><td>15:</td><td>8.4</td><td>↗</td></tr> <tr><td>16:</td><td>10.2</td><td>↘</td></tr> <tr><td>17:</td><td>6.7</td><td>↑</td></tr> <tr><td>18:</td><td>8.3</td><td>↑</td></tr> <tr><td>19:</td><td>8.3</td><td>↓</td></tr> <tr><td>20:</td><td>8.1</td><td>→</td></tr> <tr><td colspan="2">Series</td><td>82 (0x)</td></tr> <tr><td colspan="2"></td><td>170 (1x)</td></tr> </table>	11:	8.4	↗	12:	8.9	↑	13:	9.4	↑	14:	9.4	↘	15:	8.4	↗	16:	10.2	↘	17:	6.7	↑	18:	8.3	↑	19:	8.3	↓	20:	8.1	→	Series		82 (0x)			170 (1x)
1:	7.3	↗																																																																									
2:	10.5x	↑																																																																									
3:	8.5	←																																																																									
4:	9.8	↘																																																																									
5:	9.9	↑																																																																									
6:	10.0	←																																																																									
7:	9.7	↘																																																																									
8:	9.6	↗																																																																									
9:	8.6	↗																																																																									
10:	9.3	↗																																																																									
Series		88 (1x)																																																																									
		88 (1x)																																																																									
11:	8.4	↗																																																																									
12:	8.9	↑																																																																									
13:	9.4	↑																																																																									
14:	9.4	↘																																																																									
15:	8.4	↗																																																																									
16:	10.2	↘																																																																									
17:	6.7	↑																																																																									
18:	8.3	↑																																																																									
19:	8.3	↓																																																																									
20:	8.1	→																																																																									
Series		82 (0x)																																																																									
		170 (1x)																																																																									
<p>60 Shots</p>	<table border="1" style="width:100%; border-collapse: collapse;"> <tr><td>21:</td><td>8.4</td><td>↘</td></tr> <tr><td>22:</td><td>9.4</td><td>↘</td></tr> <tr><td>23:</td><td>9.4</td><td>↑</td></tr> <tr><td>24:</td><td>9.6</td><td>→</td></tr> <tr><td>25:</td><td>8.0</td><td>←</td></tr> <tr><td>26:</td><td>10.1</td><td>↘</td></tr> <tr><td>27:</td><td>9.5</td><td>→</td></tr> <tr><td>28:</td><td>10.2</td><td>↓</td></tr> <tr><td>29:</td><td>10.3</td><td>↓</td></tr> <tr><td>30:</td><td>9.9</td><td>↓</td></tr> <tr><td colspan="2">Series</td><td>91 (0x)</td></tr> <tr><td colspan="2"></td><td>261 (1x)</td></tr> </table>	21:	8.4	↘	22:	9.4	↘	23:	9.4	↑	24:	9.6	→	25:	8.0	←	26:	10.1	↘	27:	9.5	→	28:	10.2	↓	29:	10.3	↓	30:	9.9	↓	Series		91 (0x)			261 (1x)	<p>60 Shots</p>	<table border="1" style="width:100%; border-collapse: collapse;"> <tr><td>31:</td><td>9.3</td><td>↗</td></tr> <tr><td>32:</td><td>9.9</td><td>↓</td></tr> <tr><td>33:</td><td>8.2</td><td>↑</td></tr> <tr><td>34:</td><td>10.2</td><td>↘</td></tr> <tr><td>35:</td><td>9.0</td><td>←</td></tr> <tr><td>36:</td><td>8.5</td><td>↓</td></tr> <tr><td>37:</td><td>9.9</td><td>↙</td></tr> <tr><td>38:</td><td>8.5</td><td>↗</td></tr> <tr><td>39:</td><td>10.1</td><td>←</td></tr> <tr><td>40:</td><td>9.5</td><td>↘</td></tr> <tr><td colspan="2">Series</td><td>89 (0x)</td></tr> <tr><td colspan="2"></td><td>350 (1x)</td></tr> </table>	31:	9.3	↗	32:	9.9	↓	33:	8.2	↑	34:	10.2	↘	35:	9.0	←	36:	8.5	↓	37:	9.9	↙	38:	8.5	↗	39:	10.1	←	40:	9.5	↘	Series		89 (0x)			350 (1x)
21:	8.4	↘																																																																									
22:	9.4	↘																																																																									
23:	9.4	↑																																																																									
24:	9.6	→																																																																									
25:	8.0	←																																																																									
26:	10.1	↘																																																																									
27:	9.5	→																																																																									
28:	10.2	↓																																																																									
29:	10.3	↓																																																																									
30:	9.9	↓																																																																									
Series		91 (0x)																																																																									
		261 (1x)																																																																									
31:	9.3	↗																																																																									
32:	9.9	↓																																																																									
33:	8.2	↑																																																																									
34:	10.2	↘																																																																									
35:	9.0	←																																																																									
36:	8.5	↓																																																																									
37:	9.9	↙																																																																									
38:	8.5	↗																																																																									
39:	10.1	←																																																																									
40:	9.5	↘																																																																									
Series		89 (0x)																																																																									
		350 (1x)																																																																									
<p>60 Shots</p>	<table border="1" style="width:100%; border-collapse: collapse;"> <tr><td>41:</td><td>9.9</td><td>↗</td></tr> <tr><td>42:</td><td>7.9</td><td>↑</td></tr> <tr><td>43:</td><td>10.5x</td><td>←</td></tr> <tr><td>44:</td><td>9.2</td><td>→</td></tr> <tr><td>45:</td><td>8.1</td><td>←</td></tr> <tr><td>46:</td><td>9.6</td><td>↗</td></tr> <tr><td>47:</td><td>9.6</td><td>←</td></tr> <tr><td>48:</td><td>9.5</td><td>↗</td></tr> <tr><td>49:</td><td>9.3</td><td>→</td></tr> <tr><td>50:</td><td>10.4x</td><td>↓</td></tr> <tr><td colspan="2">Series</td><td>89 (2x)</td></tr> <tr><td colspan="2"></td><td>439 (3x)</td></tr> </table>	41:	9.9	↗	42:	7.9	↑	43:	10.5x	←	44:	9.2	→	45:	8.1	←	46:	9.6	↗	47:	9.6	←	48:	9.5	↗	49:	9.3	→	50:	10.4x	↓	Series		89 (2x)			439 (3x)	<p>60 Shots</p>	<table border="1" style="width:100%; border-collapse: collapse;"> <tr><td>51:</td><td>10.7x</td><td>←</td></tr> <tr><td>52:</td><td>8.1</td><td>↓</td></tr> <tr><td>53:</td><td>10.2</td><td>↖</td></tr> <tr><td>54:</td><td>9.5</td><td>↓</td></tr> <tr><td>55:</td><td>7.2</td><td>↘</td></tr> <tr><td>56:</td><td>10.2</td><td>↓</td></tr> <tr><td>57:</td><td>8.3</td><td>↑</td></tr> <tr><td>58:</td><td>9.1</td><td>→</td></tr> <tr><td>59:</td><td>10.3</td><td>↗</td></tr> <tr><td>60:</td><td>10.0</td><td>↑</td></tr> <tr><td colspan="2">Series</td><td>91 (1x)</td></tr> <tr><td colspan="2"></td><td>530 (4x)</td></tr> </table>	51:	10.7x	←	52:	8.1	↓	53:	10.2	↖	54:	9.5	↓	55:	7.2	↘	56:	10.2	↓	57:	8.3	↑	58:	9.1	→	59:	10.3	↗	60:	10.0	↑	Series		91 (1x)			530 (4x)
41:	9.9	↗																																																																									
42:	7.9	↑																																																																									
43:	10.5x	←																																																																									
44:	9.2	→																																																																									
45:	8.1	←																																																																									
46:	9.6	↗																																																																									
47:	9.6	←																																																																									
48:	9.5	↗																																																																									
49:	9.3	→																																																																									
50:	10.4x	↓																																																																									
Series		89 (2x)																																																																									
		439 (3x)																																																																									
51:	10.7x	←																																																																									
52:	8.1	↓																																																																									
53:	10.2	↖																																																																									
54:	9.5	↓																																																																									
55:	7.2	↘																																																																									
56:	10.2	↓																																																																									
57:	8.3	↑																																																																									
58:	9.1	→																																																																									
59:	10.3	↗																																																																									
60:	10.0	↑																																																																									
Series		91 (1x)																																																																									
		530 (4x)																																																																									

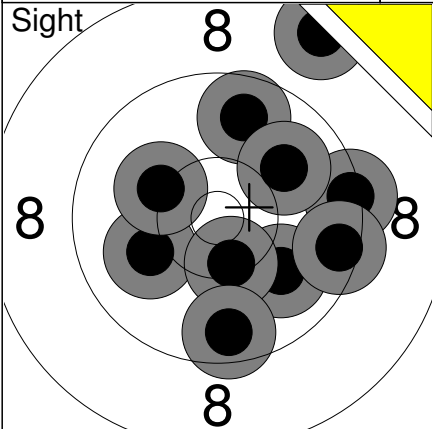
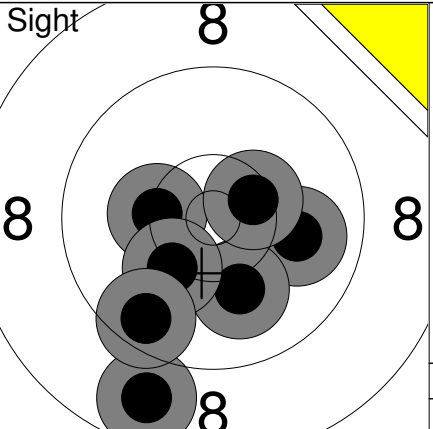
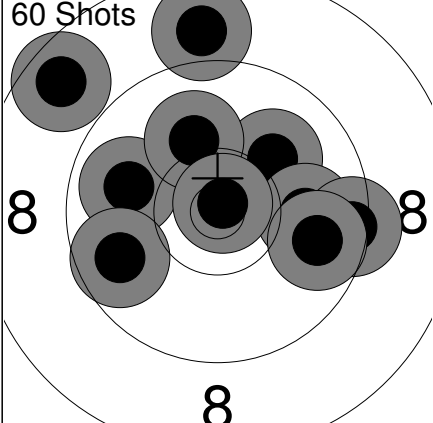
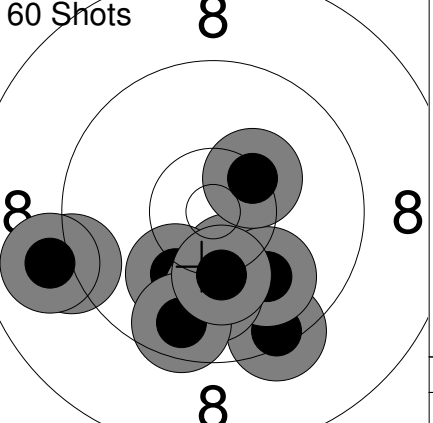
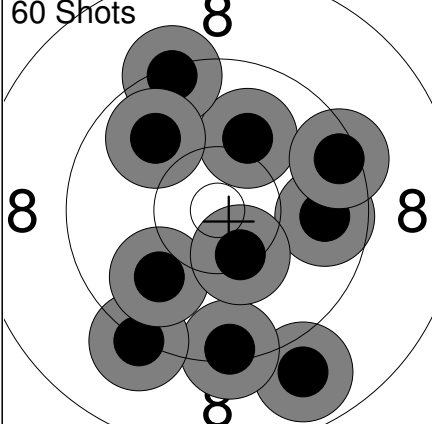
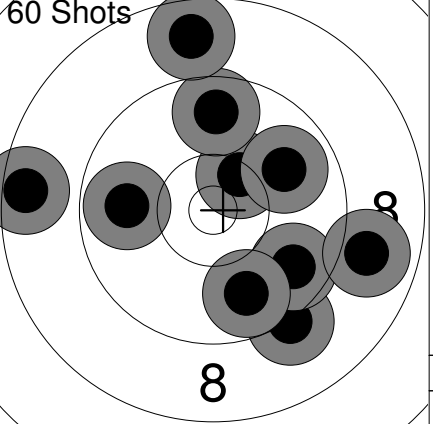
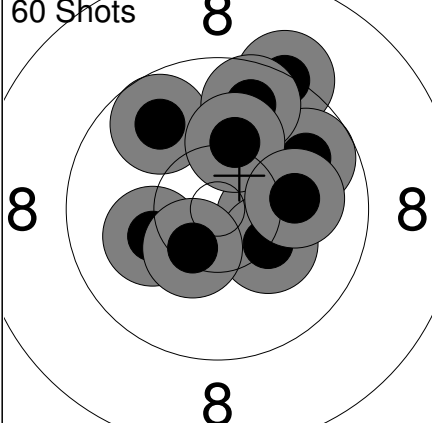
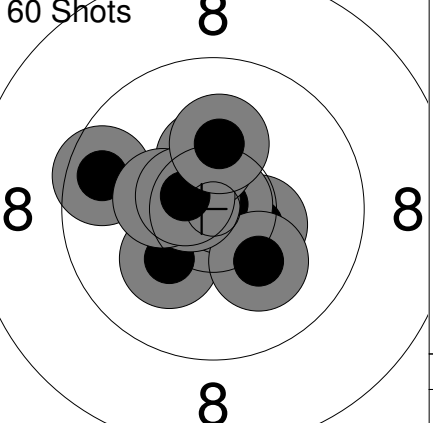

Sight	Sight																																																																									
																																																																										
	<table style="width:100%; border-collapse: collapse;"> <tr><td style="width:5%;">1:</td><td style="width:15%;">9.4</td><td style="width:5%;">→</td></tr> <tr><td>2:</td><td>10.1</td><td>←</td></tr> <tr><td>3:</td><td>10.0</td><td>↘</td></tr> <tr><td>4:</td><td>9.7</td><td>↑</td></tr> <tr><td>5:</td><td>9.5</td><td>→</td></tr> <tr><td>6:</td><td>10.4x</td><td>↘</td></tr> <tr><td>7:</td><td>10.0</td><td>→</td></tr> <tr><td>8:</td><td>8.4</td><td>↑</td></tr> <tr><td>9:</td><td>9.6</td><td>↘</td></tr> <tr><td>10:</td><td>10.2</td><td>↑</td></tr> <tr><td colspan="2">Series</td><td>94 ( 1x)</td></tr> <tr><td colspan="2"></td><td>0 ( 0x)</td></tr> </table>	1:	9.4	→	2:	10.1	←	3:	10.0	↘	4:	9.7	↑	5:	9.5	→	6:	10.4x	↘	7:	10.0	→	8:	8.4	↑	9:	9.6	↘	10:	10.2	↑	Series		94 ( 1x)			0 ( 0x)	<table style="width:100%; border-collapse: collapse;"> <tr><td style="width:5%;">11:</td><td style="width:15%;">10.0</td><td style="width:5%;">→</td></tr> <tr><td>12:</td><td>10.1</td><td>↘</td></tr> <tr><td>13:</td><td>10.3</td><td>←</td></tr> <tr><td>14:</td><td>8.8</td><td>↘</td></tr> <tr><td>15:</td><td>10.2</td><td>↘</td></tr> <tr><td>16:</td><td>9.6</td><td>↘</td></tr> <tr><td>17:</td><td>10.4x</td><td>→</td></tr> <tr><td colspan="2">Series</td><td>67 ( 1x)</td></tr> <tr><td colspan="2"></td><td>0 ( 0x)</td></tr> </table>	11:	10.0	→	12:	10.1	↘	13:	10.3	←	14:	8.8	↘	15:	10.2	↘	16:	9.6	↘	17:	10.4x	→	Series		67 ( 1x)			0 ( 0x)									
1:	9.4	→																																																																								
2:	10.1	←																																																																								
3:	10.0	↘																																																																								
4:	9.7	↑																																																																								
5:	9.5	→																																																																								
6:	10.4x	↘																																																																								
7:	10.0	→																																																																								
8:	8.4	↑																																																																								
9:	9.6	↘																																																																								
10:	10.2	↑																																																																								
Series		94 ( 1x)																																																																								
		0 ( 0x)																																																																								
11:	10.0	→																																																																								
12:	10.1	↘																																																																								
13:	10.3	←																																																																								
14:	8.8	↘																																																																								
15:	10.2	↘																																																																								
16:	9.6	↘																																																																								
17:	10.4x	→																																																																								
Series		67 ( 1x)																																																																								
		0 ( 0x)																																																																								
60 Shots	60 Shots																																																																									
																																																																										
	<table style="width:100%; border-collapse: collapse;"> <tr><td style="width:5%;">1:</td><td style="width:15%;">10.1</td><td style="width:5%;">↗</td></tr> <tr><td>2:</td><td>9.9</td><td>←</td></tr> <tr><td>3:</td><td>10.1</td><td>↗</td></tr> <tr><td>4:</td><td>10.0</td><td>→</td></tr> <tr><td>5:</td><td>8.9</td><td>↑</td></tr> <tr><td>6:</td><td>8.6</td><td>↗</td></tr> <tr><td>7:</td><td>9.4</td><td>→</td></tr> <tr><td>8:</td><td>9.7</td><td>←</td></tr> <tr><td>9:</td><td>9.8</td><td>→</td></tr> <tr><td>10:</td><td>10.8x</td><td>↗</td></tr> <tr><td colspan="2">Series</td><td>92 ( 1x)</td></tr> <tr><td colspan="2"></td><td>92 ( 1x)</td></tr> </table>	1:	10.1	↗	2:	9.9	←	3:	10.1	↗	4:	10.0	→	5:	8.9	↑	6:	8.6	↗	7:	9.4	→	8:	9.7	←	9:	9.8	→	10:	10.8x	↗	Series		92 ( 1x)			92 ( 1x)	<table style="width:100%; border-collapse: collapse;"> <tr><td style="width:5%;">11:</td><td style="width:15%;">10.3</td><td style="width:5%;">↘</td></tr> <tr><td>12:</td><td>10.1</td><td>↘</td></tr> <tr><td>13:</td><td>9.4</td><td>↘</td></tr> <tr><td>14:</td><td>9.2</td><td>←</td></tr> <tr><td>15:</td><td>10.0</td><td>↘</td></tr> <tr><td>16:</td><td>9.0</td><td>←</td></tr> <tr><td>17:</td><td>10.0</td><td>↘</td></tr> <tr><td>18:</td><td>10.4x</td><td>↗</td></tr> <tr><td>19:</td><td>9.6</td><td>↘</td></tr> <tr><td>20:</td><td>10.2</td><td>↘</td></tr> <tr><td colspan="2">Series</td><td>96 ( 1x)</td></tr> <tr><td colspan="2"></td><td>188 ( 2x)</td></tr> </table>	11:	10.3	↘	12:	10.1	↘	13:	9.4	↘	14:	9.2	←	15:	10.0	↘	16:	9.0	←	17:	10.0	↘	18:	10.4x	↗	19:	9.6	↘	20:	10.2	↘	Series		96 ( 1x)			188 ( 2x)
1:	10.1	↗																																																																								
2:	9.9	←																																																																								
3:	10.1	↗																																																																								
4:	10.0	→																																																																								
5:	8.9	↑																																																																								
6:	8.6	↗																																																																								
7:	9.4	→																																																																								
8:	9.7	←																																																																								
9:	9.8	→																																																																								
10:	10.8x	↗																																																																								
Series		92 ( 1x)																																																																								
		92 ( 1x)																																																																								
11:	10.3	↘																																																																								
12:	10.1	↘																																																																								
13:	9.4	↘																																																																								
14:	9.2	←																																																																								
15:	10.0	↘																																																																								
16:	9.0	←																																																																								
17:	10.0	↘																																																																								
18:	10.4x	↗																																																																								
19:	9.6	↘																																																																								
20:	10.2	↘																																																																								
Series		96 ( 1x)																																																																								
		188 ( 2x)																																																																								
60 Shots	60 Shots																																																																									
																																																																										
	<table style="width:100%; border-collapse: collapse;"> <tr><td style="width:5%;">21:</td><td style="width:15%;">10.1</td><td style="width:5%;">↗</td></tr> <tr><td>22:</td><td>8.9</td><td>↘</td></tr> <tr><td>23:</td><td>9.4</td><td>↘</td></tr> <tr><td>24:</td><td>9.7</td><td>→</td></tr> <tr><td>25:</td><td>9.3</td><td>↗</td></tr> <tr><td>26:</td><td>9.2</td><td>↘</td></tr> <tr><td>27:</td><td>9.9</td><td>↗</td></tr> <tr><td>28:</td><td>9.4</td><td>→</td></tr> <tr><td>29:</td><td>9.9</td><td>↘</td></tr> <tr><td>30:</td><td>10.4x</td><td>↘</td></tr> <tr><td colspan="2">Series</td><td>91 ( 1x)</td></tr> <tr><td colspan="2"></td><td>279 ( 3x)</td></tr> </table>	21:	10.1	↗	22:	8.9	↘	23:	9.4	↘	24:	9.7	→	25:	9.3	↗	26:	9.2	↘	27:	9.9	↗	28:	9.4	→	29:	9.9	↘	30:	10.4x	↘	Series		91 ( 1x)			279 ( 3x)	<table style="width:100%; border-collapse: collapse;"> <tr><td style="width:5%;">31:</td><td style="width:15%;">9.2</td><td style="width:5%;">↘</td></tr> <tr><td>32:</td><td>9.7</td><td>↘</td></tr> <tr><td>33:</td><td>10.4x</td><td>↗</td></tr> <tr><td>34:</td><td>9.8</td><td>←</td></tr> <tr><td>35:</td><td>9.7</td><td>↑</td></tr> <tr><td>36:</td><td>8.9</td><td>→</td></tr> <tr><td>37:</td><td>9.8</td><td>↘</td></tr> <tr><td>38:</td><td>8.5</td><td>←</td></tr> <tr><td>39:</td><td>9.9</td><td>↗</td></tr> <tr><td>40:</td><td>8.7</td><td>↑</td></tr> <tr><td colspan="2">Series</td><td>88 ( 1x)</td></tr> <tr><td colspan="2"></td><td>367 ( 4x)</td></tr> </table>	31:	9.2	↘	32:	9.7	↘	33:	10.4x	↗	34:	9.8	←	35:	9.7	↑	36:	8.9	→	37:	9.8	↘	38:	8.5	←	39:	9.9	↗	40:	8.7	↑	Series		88 ( 1x)			367 ( 4x)
21:	10.1	↗																																																																								
22:	8.9	↘																																																																								
23:	9.4	↘																																																																								
24:	9.7	→																																																																								
25:	9.3	↗																																																																								
26:	9.2	↘																																																																								
27:	9.9	↗																																																																								
28:	9.4	→																																																																								
29:	9.9	↘																																																																								
30:	10.4x	↘																																																																								
Series		91 ( 1x)																																																																								
		279 ( 3x)																																																																								
31:	9.2	↘																																																																								
32:	9.7	↘																																																																								
33:	10.4x	↗																																																																								
34:	9.8	←																																																																								
35:	9.7	↑																																																																								
36:	8.9	→																																																																								
37:	9.8	↘																																																																								
38:	8.5	←																																																																								
39:	9.9	↗																																																																								
40:	8.7	↑																																																																								
Series		88 ( 1x)																																																																								
		367 ( 4x)																																																																								
60 Shots	60 Shots																																																																									
																																																																										
	<table style="width:100%; border-collapse: collapse;"> <tr><td style="width:5%;">41:</td><td style="width:15%;">9.3</td><td style="width:5%;">↗</td></tr> <tr><td>42:</td><td>10.4x</td><td>→</td></tr> <tr><td>43:</td><td>9.8</td><td>→</td></tr> <tr><td>44:</td><td>9.8</td><td>↗</td></tr> <tr><td>45:</td><td>10.3</td><td>↘</td></tr> <tr><td>46:</td><td>10.2</td><td>←</td></tr> <tr><td>47:</td><td>9.7</td><td>↗</td></tr> <tr><td>48:</td><td>10.4x</td><td>↘</td></tr> <tr><td>49:</td><td>10.2</td><td>↑</td></tr> <tr><td>50:</td><td>10.1</td><td>→</td></tr> <tr><td colspan="2">Series</td><td>96 ( 2x)</td></tr> <tr><td colspan="2"></td><td>463 ( 6x)</td></tr> </table>	41:	9.3	↗	42:	10.4x	→	43:	9.8	→	44:	9.8	↗	45:	10.3	↘	46:	10.2	←	47:	9.7	↗	48:	10.4x	↘	49:	10.2	↑	50:	10.1	→	Series		96 ( 2x)			463 ( 6x)	<table style="width:100%; border-collapse: collapse;"> <tr><td style="width:5%;">51:</td><td style="width:15%;">9.6</td><td style="width:5%;">←</td></tr> <tr><td>52:</td><td>10.4x</td><td>→</td></tr> <tr><td>53:</td><td>10.2</td><td>↘</td></tr> <tr><td>54:</td><td>10.8x</td><td>→</td></tr> <tr><td>55:</td><td>10.2</td><td>↘</td></tr> <tr><td>56:</td><td>10.7x</td><td>←</td></tr> <tr><td>57:</td><td>10.4x</td><td>↑</td></tr> <tr><td>58:</td><td>10.4x</td><td>←</td></tr> <tr><td>59:</td><td>10.6x</td><td>←</td></tr> <tr><td>60:</td><td>10.2</td><td>↑</td></tr> <tr><td colspan="2">Series</td><td>99 ( 6x)</td></tr> <tr><td colspan="2"></td><td>562 ( 12x)</td></tr> </table>	51:	9.6	←	52:	10.4x	→	53:	10.2	↘	54:	10.8x	→	55:	10.2	↘	56:	10.7x	←	57:	10.4x	↑	58:	10.4x	←	59:	10.6x	←	60:	10.2	↑	Series		99 ( 6x)			562 ( 12x)
41:	9.3	↗																																																																								
42:	10.4x	→																																																																								
43:	9.8	→																																																																								
44:	9.8	↗																																																																								
45:	10.3	↘																																																																								
46:	10.2	←																																																																								
47:	9.7	↗																																																																								
48:	10.4x	↘																																																																								
49:	10.2	↑																																																																								
50:	10.1	→																																																																								
Series		96 ( 2x)																																																																								
		463 ( 6x)																																																																								
51:	9.6	←																																																																								
52:	10.4x	→																																																																								
53:	10.2	↘																																																																								
54:	10.8x	→																																																																								
55:	10.2	↘																																																																								
56:	10.7x	←																																																																								
57:	10.4x	↑																																																																								
58:	10.4x	←																																																																								
59:	10.6x	←																																																																								
60:	10.2	↑																																																																								
Series		99 ( 6x)																																																																								
		562 ( 12x)																																																																								

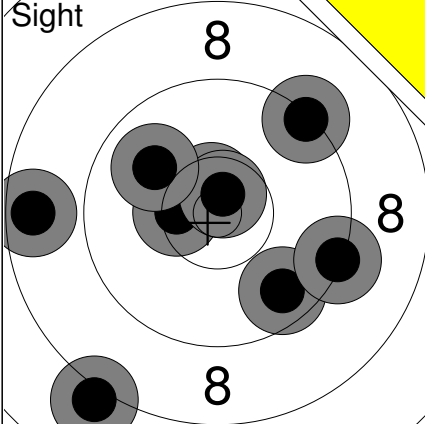
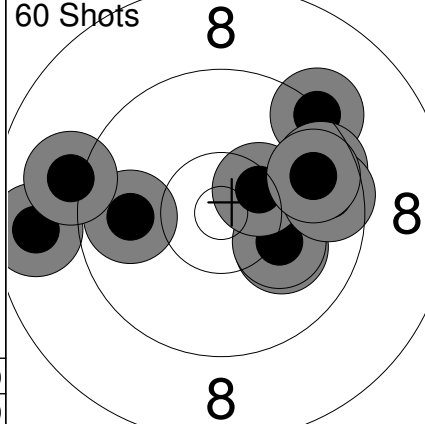
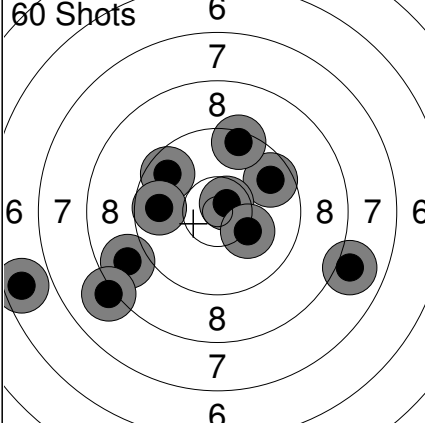
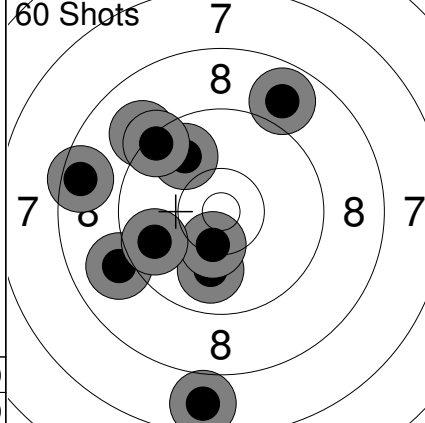
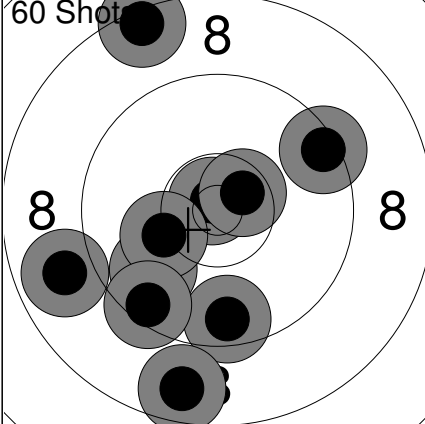
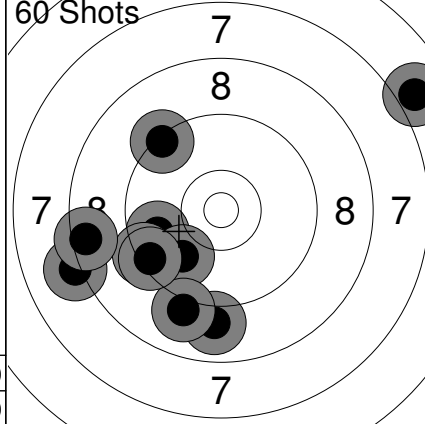
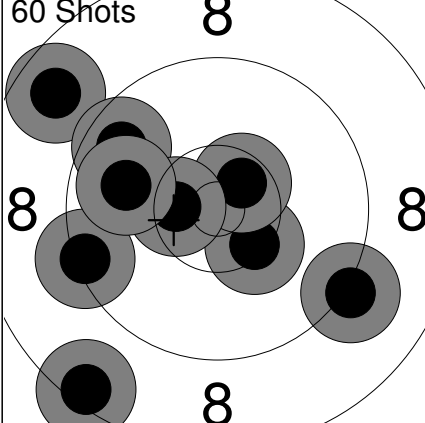

<b>Sight</b> 	<b>60 Shots</b> 	<table border="1" style="width:100%; border-collapse: collapse;"> <tr><td>1: 10.6x</td><td>↑</td></tr> <tr><td>2: 10.4x</td><td>←</td></tr> <tr><td>3: 9.6</td><td>↘</td></tr> <tr><td>4: 10.7x</td><td>↑</td></tr> <tr><td>5: 9.3</td><td>↗</td></tr> <tr><td>6: 9.3</td><td>→</td></tr> <tr><td>7: 8.6</td><td>←</td></tr> <tr><td>8: 8.1</td><td>↘</td></tr> <tr><td>9: 10.0</td><td>↖</td></tr> <tr><td colspan="2"><b>Series</b> 83 (3x)</td></tr> <tr><td colspan="2">0 (0x)</td></tr> </table>	1: 10.6x	↑	2: 10.4x	←	3: 9.6	↘	4: 10.7x	↑	5: 9.3	↗	6: 9.3	→	7: 8.6	←	8: 8.1	↘	9: 10.0	↖	<b>Series</b> 83 (3x)		0 (0x)		<table border="1" style="width:100%; border-collapse: collapse;"> <tr><td>1: 10.1</td><td>↘</td></tr> <tr><td>2: 9.3</td><td>↗</td></tr> <tr><td>3: 9.6</td><td>→</td></tr> <tr><td>4: 8.7</td><td>←</td></tr> <tr><td>5: 10.2</td><td>↘</td></tr> <tr><td>6: 10.4x</td><td>↗</td></tr> <tr><td>7: 9.9</td><td>←</td></tr> <tr><td>8: 9.7</td><td>→</td></tr> <tr><td>9: 9.8</td><td>↗</td></tr> <tr><td>10: 9.1</td><td>←</td></tr> <tr><td colspan="2"><b>Series</b> 92 (1x)</td></tr> <tr><td colspan="2">92 (1x)</td></tr> </table>	1: 10.1	↘	2: 9.3	↗	3: 9.6	→	4: 8.7	←	5: 10.2	↘	6: 10.4x	↗	7: 9.9	←	8: 9.7	→	9: 9.8	↗	10: 9.1	←	<b>Series</b> 92 (1x)		92 (1x)			
1: 10.6x	↑																																																		
2: 10.4x	←																																																		
3: 9.6	↘																																																		
4: 10.7x	↑																																																		
5: 9.3	↗																																																		
6: 9.3	→																																																		
7: 8.6	←																																																		
8: 8.1	↘																																																		
9: 10.0	↖																																																		
<b>Series</b> 83 (3x)																																																			
0 (0x)																																																			
1: 10.1	↘																																																		
2: 9.3	↗																																																		
3: 9.6	→																																																		
4: 8.7	←																																																		
5: 10.2	↘																																																		
6: 10.4x	↗																																																		
7: 9.9	←																																																		
8: 9.7	→																																																		
9: 9.8	↗																																																		
10: 9.1	←																																																		
<b>Series</b> 92 (1x)																																																			
92 (1x)																																																			
<b>60 Shots</b> 	<b>60 Shots</b> 	<table border="1" style="width:100%; border-collapse: collapse;"> <tr><td>11: 9.7</td><td>↗</td></tr> <tr><td>12: 8.8</td><td>←</td></tr> <tr><td>13: 6.6</td><td>←</td></tr> <tr><td>14: 10.7x</td><td>↗</td></tr> <tr><td>15: 9.4</td><td>↑</td></tr> <tr><td>16: 8.1</td><td>←</td></tr> <tr><td>17: 8.0</td><td>→</td></tr> <tr><td>18: 9.7</td><td>↗</td></tr> <tr><td>19: 10.2</td><td>↘</td></tr> <tr><td>20: 9.7</td><td>←</td></tr> <tr><td colspan="2"><b>Series</b> 86 (1x)</td></tr> <tr><td colspan="2">178 (2x)</td></tr> </table>	11: 9.7	↗	12: 8.8	←	13: 6.6	←	14: 10.7x	↗	15: 9.4	↑	16: 8.1	←	17: 8.0	→	18: 9.7	↗	19: 10.2	↘	20: 9.7	←	<b>Series</b> 86 (1x)		178 (2x)		<table border="1" style="width:100%; border-collapse: collapse;"> <tr><td>21: 9.0</td><td>←</td></tr> <tr><td>22: 7.7</td><td>↓</td></tr> <tr><td>23: 9.1</td><td>↖</td></tr> <tr><td>24: 10.0</td><td>↓</td></tr> <tr><td>25: 10.4x</td><td>↓</td></tr> <tr><td>26: 9.9</td><td>↖</td></tr> <tr><td>27: 8.5</td><td>←</td></tr> <tr><td>28: 9.7</td><td>←</td></tr> <tr><td>29: 9.4</td><td>↖</td></tr> <tr><td>30: 8.8</td><td>↑</td></tr> <tr><td colspan="2"><b>Series</b> 88 (1x)</td></tr> <tr><td colspan="2">266 (3x)</td></tr> </table>	21: 9.0	←	22: 7.7	↓	23: 9.1	↖	24: 10.0	↓	25: 10.4x	↓	26: 9.9	↖	27: 8.5	←	28: 9.7	←	29: 9.4	↖	30: 8.8	↑	<b>Series</b> 88 (1x)		266 (3x)	
11: 9.7	↗																																																		
12: 8.8	←																																																		
13: 6.6	←																																																		
14: 10.7x	↗																																																		
15: 9.4	↑																																																		
16: 8.1	←																																																		
17: 8.0	→																																																		
18: 9.7	↗																																																		
19: 10.2	↘																																																		
20: 9.7	←																																																		
<b>Series</b> 86 (1x)																																																			
178 (2x)																																																			
21: 9.0	←																																																		
22: 7.7	↓																																																		
23: 9.1	↖																																																		
24: 10.0	↓																																																		
25: 10.4x	↓																																																		
26: 9.9	↖																																																		
27: 8.5	←																																																		
28: 9.7	←																																																		
29: 9.4	↖																																																		
30: 8.8	↑																																																		
<b>Series</b> 88 (1x)																																																			
266 (3x)																																																			
<b>60 Shots</b> 	<b>60 Shots</b> 	<table border="1" style="width:100%; border-collapse: collapse;"> <tr><td>31: 10.8x</td><td>↖</td></tr> <tr><td>32: 9.8</td><td>←</td></tr> <tr><td>33: 9.6</td><td>↓</td></tr> <tr><td>34: 8.7</td><td>↓</td></tr> <tr><td>35: 9.4</td><td>↗</td></tr> <tr><td>36: 8.4</td><td>↑</td></tr> <tr><td>37: 10.6x</td><td>↗</td></tr> <tr><td>38: 10.2</td><td>←</td></tr> <tr><td>39: 8.9</td><td>←</td></tr> <tr><td>40: 9.5</td><td>↘</td></tr> <tr><td colspan="2"><b>Series</b> 90 (2x)</td></tr> <tr><td colspan="2">356 (5x)</td></tr> </table>	31: 10.8x	↖	32: 9.8	←	33: 9.6	↓	34: 8.7	↓	35: 9.4	↗	36: 8.4	↑	37: 10.6x	↗	38: 10.2	←	39: 8.9	←	40: 9.5	↘	<b>Series</b> 90 (2x)		356 (5x)		<table border="1" style="width:100%; border-collapse: collapse;"> <tr><td>41: 9.3</td><td>↖</td></tr> <tr><td>42: 6.9</td><td>↗</td></tr> <tr><td>43: 8.1</td><td>←</td></tr> <tr><td>44: 9.7</td><td>←</td></tr> <tr><td>45: 8.9</td><td>↓</td></tr> <tr><td>46: 9.4</td><td>←</td></tr> <tr><td>47: 8.5</td><td>←</td></tr> <tr><td>48: 9.9</td><td>↘</td></tr> <tr><td>49: 9.0</td><td>↓</td></tr> <tr><td>50: 9.4</td><td>←</td></tr> <tr><td colspan="2"><b>Series</b> 84 (0x)</td></tr> <tr><td colspan="2">440 (5x)</td></tr> </table>	41: 9.3	↖	42: 6.9	↗	43: 8.1	←	44: 9.7	←	45: 8.9	↓	46: 9.4	←	47: 8.5	←	48: 9.9	↘	49: 9.0	↓	50: 9.4	←	<b>Series</b> 84 (0x)		440 (5x)	
31: 10.8x	↖																																																		
32: 9.8	←																																																		
33: 9.6	↓																																																		
34: 8.7	↓																																																		
35: 9.4	↗																																																		
36: 8.4	↑																																																		
37: 10.6x	↗																																																		
38: 10.2	←																																																		
39: 8.9	←																																																		
40: 9.5	↘																																																		
<b>Series</b> 90 (2x)																																																			
356 (5x)																																																			
41: 9.3	↖																																																		
42: 6.9	↗																																																		
43: 8.1	←																																																		
44: 9.7	←																																																		
45: 8.9	↓																																																		
46: 9.4	←																																																		
47: 8.5	←																																																		
48: 9.9	↘																																																		
49: 9.0	↓																																																		
50: 9.4	←																																																		
<b>Series</b> 84 (0x)																																																			
440 (5x)																																																			
<b>60 Shots</b> 	<table border="1" style="width:100%; border-collapse: collapse;"> <tr><td>51: 10.8x</td><td>→</td></tr> <tr><td>52: 8.7</td><td>↖</td></tr> <tr><td>53: 9.6</td><td>↖</td></tr> <tr><td>54: 9.3</td><td>←</td></tr> <tr><td>55: 10.4x</td><td>↘</td></tr> <tr><td>56: 10.5x</td><td>↗</td></tr> <tr><td>57: 10.5x</td><td>←</td></tr> <tr><td>58: 9.2</td><td>↘</td></tr> <tr><td>59: 9.9</td><td>↖</td></tr> <tr><td>60: 8.4</td><td>↘</td></tr> <tr><td colspan="2"><b>Series</b> 92 (4x)</td></tr> <tr><td colspan="2">532 (9x)</td></tr> </table>	51: 10.8x	→	52: 8.7	↖	53: 9.6	↖	54: 9.3	←	55: 10.4x	↘	56: 10.5x	↗	57: 10.5x	←	58: 9.2	↘	59: 9.9	↖	60: 8.4	↘	<b>Series</b> 92 (4x)		532 (9x)		<table border="1" style="width:100%; border-collapse: collapse;"> <tr><td colspan="2"><b>Series</b> 84 (0x)</td></tr> <tr><td colspan="2">440 (5x)</td></tr> </table>	<b>Series</b> 84 (0x)		440 (5x)																						
51: 10.8x	→																																																		
52: 8.7	↖																																																		
53: 9.6	↖																																																		
54: 9.3	←																																																		
55: 10.4x	↘																																																		
56: 10.5x	↗																																																		
57: 10.5x	←																																																		
58: 9.2	↘																																																		
59: 9.9	↖																																																		
60: 8.4	↘																																																		
<b>Series</b> 92 (4x)																																																			
532 (9x)																																																			
<b>Series</b> 84 (0x)																																																			
440 (5x)																																																			

Relay **2** Lane **15** **LE SIEUR Audrey anne**

2023 SFC Pistol Nationals QC EX WP

16.07.2023 23PN-AP-Q2 Alberta Handgun Association

Comment Signature

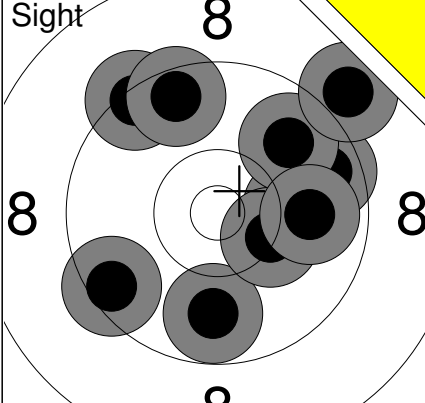
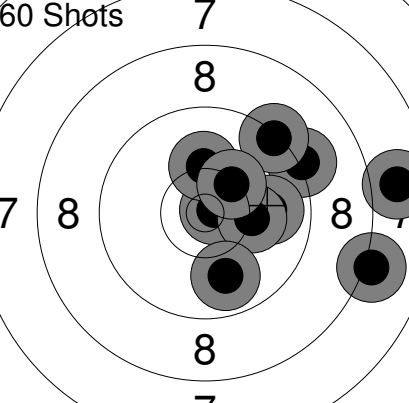
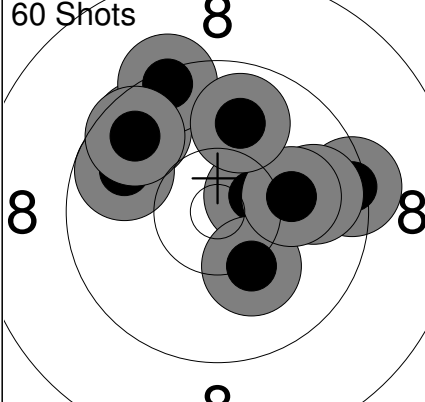
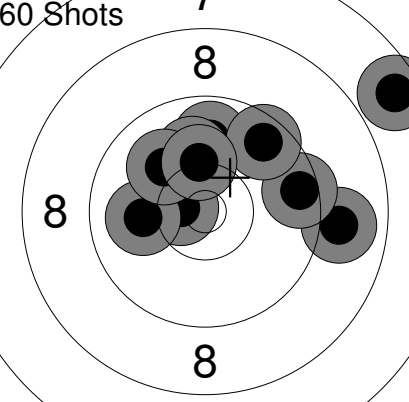
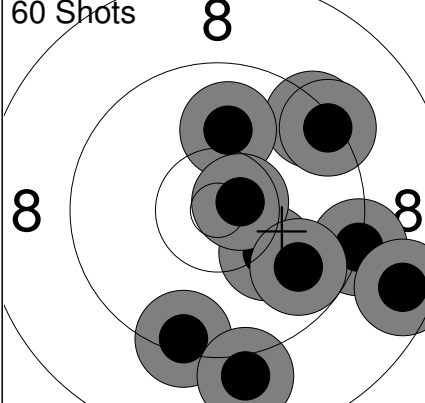
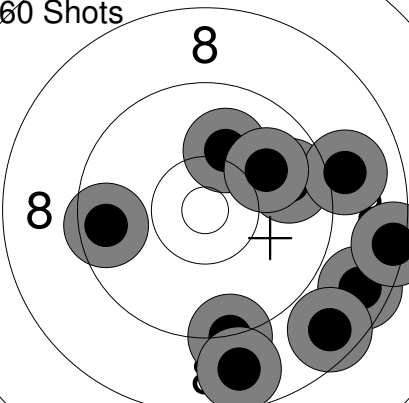
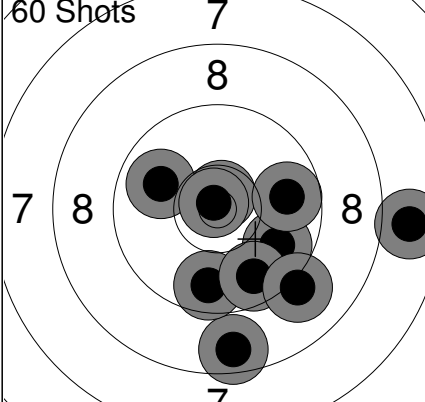
<p>Sight <b>8</b></p> 	<p>1: 9.6 → 2: 9.8 ↓ 3: 9.4 ↗ 4: 10.1 → 5: 10.3 ↓ 6: 9.8 ↗ 7: 8.9 ↗ 8: 9.9 → 9: 9.5 ↑ 10: 9.5 ↙</p> <p>Series 91 (0x) 0 (0x)</p>	<p>60 Shots <b>7</b></p> 	<p>1: 9.2 → 2: 9.9 → 3: 10.8x → 4: 10.2 → 5: 9.3 ↗ 6: 10.2 ↑ 7: 10.3 ↗ 8: 9.9 ↓ 9: 8.1 → 10: 7.8 →</p> <p>Series 91 (1x) 91 (1x)</p>
<p>60 Shots <b>8</b></p> 	<p>11: 9.4 → 12: 9.7 ↗ 13: 9.8 ↗ 14: 10.5x → 15: 10.2 ↓ 16: 9.8 → 17: 9.4 ↗ 18: 9.7 ↗ 19: 10.1 → 20: 9.9 ↑</p> <p>Series 93 (1x) 184 (2x)</p>	<p>60 Shots <b>7</b></p> 	<p>21: 10.6x ← 22: 9.9 ↑ 23: 10.0 ← 24: 8.9 → 25: 10.1 ↑ 26: 7.6 ↗ 27: 9.5 → 28: 10.1 ↗ 29: 9.6 ↗ 30: 10.2 ↑</p> <p>Series 92 (1x) 276 (3x)</p>
<p>60 Shots <b>8</b></p> 	<p>31: 9.4 ↗ 32: 10.0 ↑ 33: 9.4 ↓ 34: 9.2 → 35: 8.6 → 36: 9.0 ↓ 37: 10.2 ↓ 38: 10.7x → 39: 9.8 ↓ 40: 9.3 ↗</p> <p>Series 92 (1x) 368 (4x)</p>	<p>60 Shots <b>8</b></p> 	<p>41: 10.1 ↑ 42: 8.6 → 43: 9.8 → 44: 9.2 ↓ 45: 8.8 ↓ 46: 9.6 ← 47: 9.0 → 48: 10.0 ↗ 49: 8.6 ↓ 50: 8.4 →</p> <p>Series 88 (0x) 456 (4x)</p>
<p>60 Shots <b>7</b></p> 	<p>51: 10.7x ↑ 52: 9.9 ↗ 53: 8.6 ↓ 54: 7.8 → 55: 9.8 ↓ 56: 9.7 ↓ 57: 9.8 → 58: 10.8x ↗ 59: 9.7 ↓ 60: 9.1 ↓</p> <p>Series 89 (2x) 545 (6x)</p>		

<p>Sight</p>	<table border="1" style="width:100%; border-collapse: collapse;"> <tr><td>1:</td><td>8.4</td><td>→</td></tr> <tr><td>2:</td><td>8.3</td><td>↗</td></tr> <tr><td>3:</td><td>9.8</td><td>↗</td></tr> <tr><td>4:</td><td>10.1</td><td>←</td></tr> <tr><td>5:</td><td>9.6</td><td>↗</td></tr> <tr><td>6:</td><td>9.6</td><td>↘</td></tr> <tr><td>7:</td><td>10.6x</td><td>↗</td></tr> <tr><td>8:</td><td>10.6x</td><td>←</td></tr> <tr><td>9:</td><td>9.8</td><td>↗</td></tr> <tr><td>10:</td><td>10.6x</td><td>↘</td></tr> <tr><td colspan="2">Series</td><td>92 (3x)</td></tr> <tr><td colspan="2"></td><td>0 (0x)</td></tr> </table>	1:	8.4	→	2:	8.3	↗	3:	9.8	↗	4:	10.1	←	5:	9.6	↗	6:	9.6	↘	7:	10.6x	↗	8:	10.6x	←	9:	9.8	↗	10:	10.6x	↘	Series		92 (3x)			0 (0x)	<p>60 Shots</p>	<table border="1" style="width:100%; border-collapse: collapse;"> <tr><td>1:</td><td>10.3</td><td>↑</td></tr> <tr><td>2:</td><td>9.0</td><td>↗</td></tr> <tr><td>3:</td><td>10.5x</td><td>↘</td></tr> <tr><td>4:</td><td>8.4</td><td>↑</td></tr> <tr><td>5:</td><td>9.3</td><td>↖</td></tr> <tr><td>6:</td><td>8.4</td><td>←</td></tr> <tr><td>7:</td><td>9.6</td><td>↗</td></tr> <tr><td>8:</td><td>8.8</td><td>↑</td></tr> <tr><td>9:</td><td>9.1</td><td>←</td></tr> <tr><td>10:</td><td>9.9</td><td>→</td></tr> <tr><td colspan="2">Series</td><td>89 (1x)</td></tr> <tr><td colspan="2"></td><td>89 (1x)</td></tr> </table>	1:	10.3	↑	2:	9.0	↗	3:	10.5x	↘	4:	8.4	↑	5:	9.3	↖	6:	8.4	←	7:	9.6	↗	8:	8.8	↑	9:	9.1	←	10:	9.9	→	Series		89 (1x)			89 (1x)
1:	8.4	→																																																																									
2:	8.3	↗																																																																									
3:	9.8	↗																																																																									
4:	10.1	←																																																																									
5:	9.6	↗																																																																									
6:	9.6	↘																																																																									
7:	10.6x	↗																																																																									
8:	10.6x	←																																																																									
9:	9.8	↗																																																																									
10:	10.6x	↘																																																																									
Series		92 (3x)																																																																									
		0 (0x)																																																																									
1:	10.3	↑																																																																									
2:	9.0	↗																																																																									
3:	10.5x	↘																																																																									
4:	8.4	↑																																																																									
5:	9.3	↖																																																																									
6:	8.4	←																																																																									
7:	9.6	↗																																																																									
8:	8.8	↑																																																																									
9:	9.1	←																																																																									
10:	9.9	→																																																																									
Series		89 (1x)																																																																									
		89 (1x)																																																																									
<p>60 Shots</p>	<table border="1" style="width:100%; border-collapse: collapse;"> <tr><td>11:</td><td>10.0</td><td>↖</td></tr> <tr><td>12:</td><td>9.1</td><td>↘</td></tr> <tr><td>13:</td><td>8.6</td><td>→</td></tr> <tr><td>14:</td><td>9.5</td><td>↗</td></tr> <tr><td>15:</td><td>9.9</td><td>↘</td></tr> <tr><td>16:</td><td>8.7</td><td>↗</td></tr> <tr><td>17:</td><td>10.1</td><td>↗</td></tr> <tr><td>18:</td><td>9.3</td><td>↑</td></tr> <tr><td>19:</td><td>8.5</td><td>↑</td></tr> <tr><td>20:</td><td>8.4</td><td>↑</td></tr> <tr><td colspan="2">Series</td><td>88 (0x)</td></tr> <tr><td colspan="2"></td><td>177 (1x)</td></tr> </table>	11:	10.0	↖	12:	9.1	↘	13:	8.6	→	14:	9.5	↗	15:	9.9	↘	16:	8.7	↗	17:	10.1	↗	18:	9.3	↑	19:	8.5	↑	20:	8.4	↑	Series		88 (0x)			177 (1x)	<p>60 Shots</p>	<table border="1" style="width:100%; border-collapse: collapse;"> <tr><td>21:</td><td>10.6x</td><td>→</td></tr> <tr><td>22:</td><td>9.0</td><td>↖</td></tr> <tr><td>23:</td><td>10.3</td><td>→</td></tr> <tr><td>24:</td><td>7.6</td><td>↗</td></tr> <tr><td>25:</td><td>9.3</td><td>↑</td></tr> <tr><td>26:</td><td>8.7</td><td>↖</td></tr> <tr><td>27:</td><td>9.7</td><td>→</td></tr> <tr><td>28:</td><td>10.3</td><td>↑</td></tr> <tr><td>29:</td><td>9.1</td><td>↑</td></tr> <tr><td>30:</td><td>9.5</td><td>→</td></tr> <tr><td colspan="2">Series</td><td>90 (1x)</td></tr> <tr><td colspan="2"></td><td>267 (2x)</td></tr> </table>	21:	10.6x	→	22:	9.0	↖	23:	10.3	→	24:	7.6	↗	25:	9.3	↑	26:	8.7	↖	27:	9.7	→	28:	10.3	↑	29:	9.1	↑	30:	9.5	→	Series		90 (1x)			267 (2x)
11:	10.0	↖																																																																									
12:	9.1	↘																																																																									
13:	8.6	→																																																																									
14:	9.5	↗																																																																									
15:	9.9	↘																																																																									
16:	8.7	↗																																																																									
17:	10.1	↗																																																																									
18:	9.3	↑																																																																									
19:	8.5	↑																																																																									
20:	8.4	↑																																																																									
Series		88 (0x)																																																																									
		177 (1x)																																																																									
21:	10.6x	→																																																																									
22:	9.0	↖																																																																									
23:	10.3	→																																																																									
24:	7.6	↗																																																																									
25:	9.3	↑																																																																									
26:	8.7	↖																																																																									
27:	9.7	→																																																																									
28:	10.3	↑																																																																									
29:	9.1	↑																																																																									
30:	9.5	→																																																																									
Series		90 (1x)																																																																									
		267 (2x)																																																																									
<p>60 Shots</p>	<table border="1" style="width:100%; border-collapse: collapse;"> <tr><td>31:</td><td>10.5x</td><td>→</td></tr> <tr><td>32:</td><td>9.2</td><td>↗</td></tr> <tr><td>33:</td><td>7.8</td><td>↘</td></tr> <tr><td>34:</td><td>10.2</td><td>→</td></tr> <tr><td>35:</td><td>9.8</td><td>→</td></tr> <tr><td>36:</td><td>8.5</td><td>↘</td></tr> <tr><td>37:</td><td>10.4x</td><td>↑</td></tr> <tr><td>38:</td><td>8.8</td><td>→</td></tr> <tr><td>39:</td><td>9.8</td><td>←</td></tr> <tr><td>40:</td><td>9.8</td><td>↖</td></tr> <tr><td colspan="2">Series</td><td>89 (2x)</td></tr> <tr><td colspan="2"></td><td>356 (4x)</td></tr> </table>	31:	10.5x	→	32:	9.2	↗	33:	7.8	↘	34:	10.2	→	35:	9.8	→	36:	8.5	↘	37:	10.4x	↑	38:	8.8	→	39:	9.8	←	40:	9.8	↖	Series		89 (2x)			356 (4x)	<p>60 Shots</p>	<table border="1" style="width:100%; border-collapse: collapse;"> <tr><td>41:</td><td>10.6x</td><td>↗</td></tr> <tr><td>42:</td><td>8.4</td><td>↘</td></tr> <tr><td>43:</td><td>9.2</td><td>↗</td></tr> <tr><td>44:</td><td>9.6</td><td>↖</td></tr> <tr><td>45:</td><td>7.7</td><td>↖</td></tr> <tr><td>46:</td><td>9.8</td><td>↗</td></tr> <tr><td>47:</td><td>10.1</td><td>↘</td></tr> <tr><td>48:</td><td>10.3</td><td>←</td></tr> <tr><td>49:</td><td>7.8</td><td>↘</td></tr> <tr><td>50:</td><td>10.3</td><td>↗</td></tr> <tr><td colspan="2">Series</td><td>89 (1x)</td></tr> <tr><td colspan="2"></td><td>445 (5x)</td></tr> </table>	41:	10.6x	↗	42:	8.4	↘	43:	9.2	↗	44:	9.6	↖	45:	7.7	↖	46:	9.8	↗	47:	10.1	↘	48:	10.3	←	49:	7.8	↘	50:	10.3	↗	Series		89 (1x)			445 (5x)
31:	10.5x	→																																																																									
32:	9.2	↗																																																																									
33:	7.8	↘																																																																									
34:	10.2	→																																																																									
35:	9.8	→																																																																									
36:	8.5	↘																																																																									
37:	10.4x	↑																																																																									
38:	8.8	→																																																																									
39:	9.8	←																																																																									
40:	9.8	↖																																																																									
Series		89 (2x)																																																																									
		356 (4x)																																																																									
41:	10.6x	↗																																																																									
42:	8.4	↘																																																																									
43:	9.2	↗																																																																									
44:	9.6	↖																																																																									
45:	7.7	↖																																																																									
46:	9.8	↗																																																																									
47:	10.1	↘																																																																									
48:	10.3	←																																																																									
49:	7.8	↘																																																																									
50:	10.3	↗																																																																									
Series		89 (1x)																																																																									
		445 (5x)																																																																									
<p>60 Shots</p>	<table border="1" style="width:100%; border-collapse: collapse;"> <tr><td>51:</td><td>6.8</td><td>←</td></tr> <tr><td>52:</td><td>7.8</td><td>↗</td></tr> <tr><td>53:</td><td>8.1</td><td>↘</td></tr> <tr><td>54:</td><td>10.5x</td><td>←</td></tr> <tr><td>55:</td><td>8.3</td><td>↘</td></tr> <tr><td>56:</td><td>9.8</td><td>↘</td></tr> <tr><td>57:</td><td>9.7</td><td>→</td></tr> <tr><td>58:</td><td>10.1</td><td>↘</td></tr> <tr><td>59:</td><td>9.7</td><td>↗</td></tr> <tr><td>60:</td><td>10.0</td><td>↘</td></tr> <tr><td colspan="2">Series</td><td>86 (1x)</td></tr> <tr><td colspan="2"></td><td>531 (6x)</td></tr> </table>	51:	6.8	←	52:	7.8	↗	53:	8.1	↘	54:	10.5x	←	55:	8.3	↘	56:	9.8	↘	57:	9.7	→	58:	10.1	↘	59:	9.7	↗	60:	10.0	↘	Series		86 (1x)			531 (6x)																																						
51:	6.8	←																																																																									
52:	7.8	↗																																																																									
53:	8.1	↘																																																																									
54:	10.5x	←																																																																									
55:	8.3	↘																																																																									
56:	9.8	↘																																																																									
57:	9.7	→																																																																									
58:	10.1	↘																																																																									
59:	9.7	↗																																																																									
60:	10.0	↘																																																																									
Series		86 (1x)																																																																									
		531 (6x)																																																																									

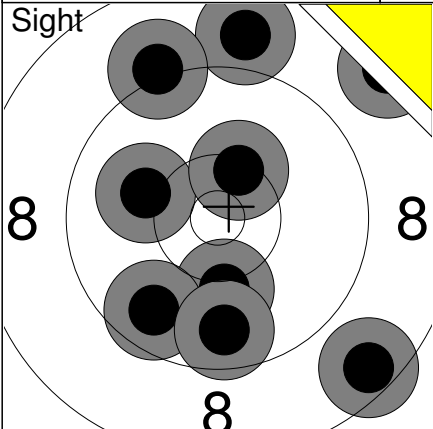
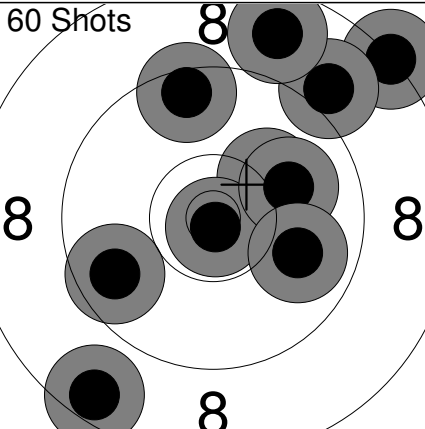
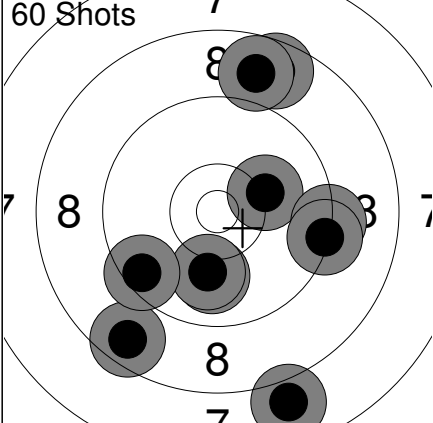
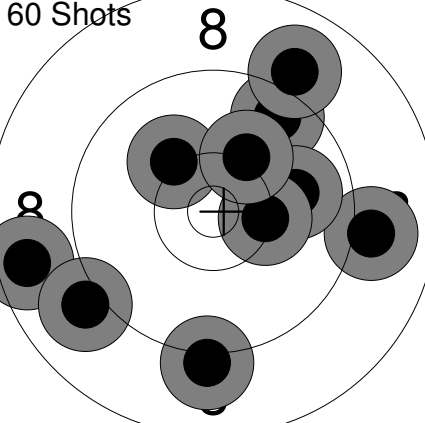
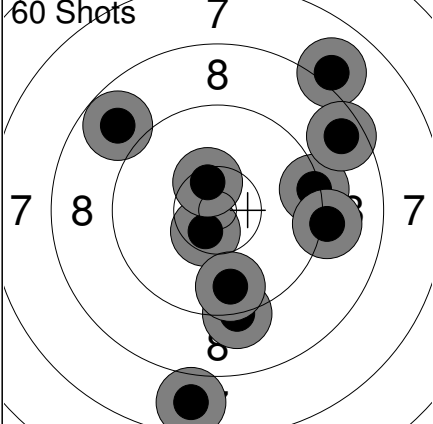
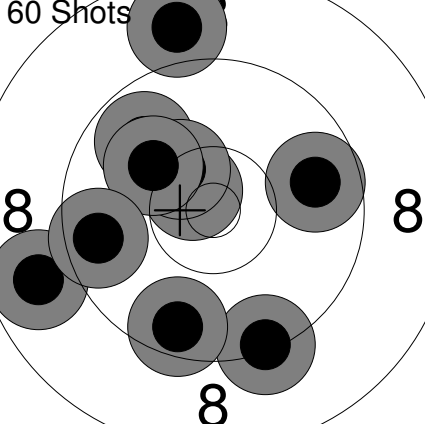
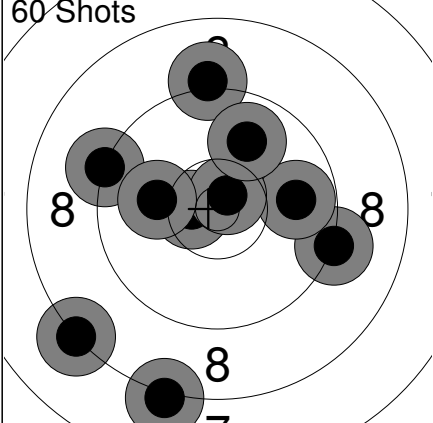
<b>Sight</b> 	<table border="1" style="width:100%; border-collapse: collapse;"> <tr><td>1:</td><td>10.1</td><td>↓</td></tr> <tr><td>2:</td><td>8.8</td><td>↑</td></tr> <tr><td>3:</td><td>8.5</td><td>↘</td></tr> <tr><td>4:</td><td>9.7</td><td>↘</td></tr> <tr><td>5:</td><td>9.7</td><td>↓</td></tr> <tr><td>6:</td><td>10.1</td><td>↖</td></tr> <tr><td>7:</td><td>9.1</td><td>↗</td></tr> <tr><td>8:</td><td>10.4</td><td>↑</td></tr> <tr><td>9:</td><td>8.4</td><td>↗</td></tr> <tr><td colspan="2"><b>Series</b></td><td>81 (0x)</td></tr> <tr><td colspan="2"></td><td>0 (0x)</td></tr> </table>	1:	10.1	↓	2:	8.8	↑	3:	8.5	↘	4:	9.7	↘	5:	9.7	↓	6:	10.1	↖	7:	9.1	↗	8:	10.4	↑	9:	8.4	↗	<b>Series</b>		81 (0x)			0 (0x)	<b>60 Shots</b> 	<table border="1" style="width:100%; border-collapse: collapse;"> <tr><td>1:</td><td>10.2</td><td>↗</td></tr> <tr><td>2:</td><td>8.2</td><td>↗</td></tr> <tr><td>3:</td><td>10.8x</td><td>↓</td></tr> <tr><td>4:</td><td>9.0</td><td>↗</td></tr> <tr><td>5:</td><td>10.0</td><td>↗</td></tr> <tr><td>6:</td><td>8.5</td><td>↘</td></tr> <tr><td>7:</td><td>9.5</td><td>↑</td></tr> <tr><td>8:</td><td>8.7</td><td>↑</td></tr> <tr><td>9:</td><td>9.7</td><td>↙</td></tr> <tr><td>10:</td><td>9.9</td><td>→</td></tr> <tr><td colspan="2"><b>Series</b></td><td>90 (1x)</td></tr> <tr><td colspan="2"></td><td>90 (1x)</td></tr> </table>	1:	10.2	↗	2:	8.2	↗	3:	10.8x	↓	4:	9.0	↗	5:	10.0	↗	6:	8.5	↘	7:	9.5	↑	8:	8.7	↑	9:	9.7	↙	10:	9.9	→	<b>Series</b>		90 (1x)			90 (1x)			
1:	10.1	↓																																																																									
2:	8.8	↑																																																																									
3:	8.5	↘																																																																									
4:	9.7	↘																																																																									
5:	9.7	↓																																																																									
6:	10.1	↖																																																																									
7:	9.1	↗																																																																									
8:	10.4	↑																																																																									
9:	8.4	↗																																																																									
<b>Series</b>		81 (0x)																																																																									
		0 (0x)																																																																									
1:	10.2	↗																																																																									
2:	8.2	↗																																																																									
3:	10.8x	↓																																																																									
4:	9.0	↗																																																																									
5:	10.0	↗																																																																									
6:	8.5	↘																																																																									
7:	9.5	↑																																																																									
8:	8.7	↑																																																																									
9:	9.7	↙																																																																									
10:	9.9	→																																																																									
<b>Series</b>		90 (1x)																																																																									
		90 (1x)																																																																									
<b>60 Shots</b> 	<table border="1" style="width:100%; border-collapse: collapse;"> <tr><td>11:</td><td>8.7</td><td>↑</td></tr> <tr><td>12:</td><td>8.8</td><td>↑</td></tr> <tr><td>13:</td><td>10.2</td><td>→</td></tr> <tr><td>14:</td><td>8.6</td><td>↘</td></tr> <tr><td>15:</td><td>10.0</td><td>↓</td></tr> <tr><td>16:</td><td>10.0</td><td>↓</td></tr> <tr><td>17:</td><td>9.3</td><td>→</td></tr> <tr><td>18:</td><td>9.3</td><td>→</td></tr> <tr><td>19:</td><td>9.5</td><td>↙</td></tr> <tr><td>20:</td><td>7.9</td><td>↓</td></tr> <tr><td colspan="2"><b>Series</b></td><td>88 (0x)</td></tr> <tr><td colspan="2"></td><td>178 (1x)</td></tr> </table>	11:	8.7	↑	12:	8.8	↑	13:	10.2	→	14:	8.6	↘	15:	10.0	↓	16:	10.0	↓	17:	9.3	→	18:	9.3	→	19:	9.5	↙	20:	7.9	↓	<b>Series</b>		88 (0x)			178 (1x)	<b>60 Shots</b> 	<table border="1" style="width:100%; border-collapse: collapse;"> <tr><td>21:</td><td>8.6</td><td>←</td></tr> <tr><td>22:</td><td>9.6</td><td>↗</td></tr> <tr><td>23:</td><td>10.2</td><td>↖</td></tr> <tr><td>24:</td><td>9.0</td><td>←</td></tr> <tr><td>25:</td><td>9.0</td><td>→</td></tr> <tr><td>26:</td><td>9.9</td><td>→</td></tr> <tr><td>27:</td><td>9.1</td><td>↓</td></tr> <tr><td>28:</td><td>10.3</td><td>→</td></tr> <tr><td>29:</td><td>10.2</td><td>↑</td></tr> <tr><td>30:</td><td>9.0</td><td>↑</td></tr> <tr><td colspan="2"><b>Series</b></td><td>92 (0x)</td></tr> <tr><td colspan="2"></td><td>270 (1x)</td></tr> </table>	21:	8.6	←	22:	9.6	↗	23:	10.2	↖	24:	9.0	←	25:	9.0	→	26:	9.9	→	27:	9.1	↓	28:	10.3	→	29:	10.2	↑	30:	9.0	↑	<b>Series</b>		92 (0x)			270 (1x)
11:	8.7	↑																																																																									
12:	8.8	↑																																																																									
13:	10.2	→																																																																									
14:	8.6	↘																																																																									
15:	10.0	↓																																																																									
16:	10.0	↓																																																																									
17:	9.3	→																																																																									
18:	9.3	→																																																																									
19:	9.5	↙																																																																									
20:	7.9	↓																																																																									
<b>Series</b>		88 (0x)																																																																									
		178 (1x)																																																																									
21:	8.6	←																																																																									
22:	9.6	↗																																																																									
23:	10.2	↖																																																																									
24:	9.0	←																																																																									
25:	9.0	→																																																																									
26:	9.9	→																																																																									
27:	9.1	↓																																																																									
28:	10.3	→																																																																									
29:	10.2	↑																																																																									
30:	9.0	↑																																																																									
<b>Series</b>		92 (0x)																																																																									
		270 (1x)																																																																									
<b>60 Shots</b> 	<table border="1" style="width:100%; border-collapse: collapse;"> <tr><td>31:</td><td>10.5x</td><td>↘</td></tr> <tr><td>32:</td><td>7.8</td><td>↓</td></tr> <tr><td>33:</td><td>9.3</td><td>→</td></tr> <tr><td>34:</td><td>9.2</td><td>↓</td></tr> <tr><td>35:</td><td>9.7</td><td>↓</td></tr> <tr><td>36:</td><td>8.0</td><td>↗</td></tr> <tr><td>37:</td><td>8.6</td><td>→</td></tr> <tr><td>38:</td><td>9.1</td><td>→</td></tr> <tr><td>39:</td><td>8.8</td><td>↖</td></tr> <tr><td>40:</td><td>10.5x</td><td>↑</td></tr> <tr><td colspan="2"><b>Series</b></td><td>87 (2x)</td></tr> <tr><td colspan="2"></td><td>357 (3x)</td></tr> </table>	31:	10.5x	↘	32:	7.8	↓	33:	9.3	→	34:	9.2	↓	35:	9.7	↓	36:	8.0	↗	37:	8.6	→	38:	9.1	→	39:	8.8	↖	40:	10.5x	↑	<b>Series</b>		87 (2x)			357 (3x)	<b>60 Shots</b> 	<table border="1" style="width:100%; border-collapse: collapse;"> <tr><td>41:</td><td>9.8</td><td>↖</td></tr> <tr><td>42:</td><td>8.8</td><td>↑</td></tr> <tr><td>43:</td><td>8.8</td><td>←</td></tr> <tr><td>44:</td><td>10.6x</td><td>↖</td></tr> <tr><td>45:</td><td>10.4x</td><td>↖</td></tr> <tr><td>46:</td><td>10.1</td><td>↖</td></tr> <tr><td>47:</td><td>9.3</td><td>↓</td></tr> <tr><td>48:</td><td>9.8</td><td>→</td></tr> <tr><td>49:</td><td>9.6</td><td>↓</td></tr> <tr><td>50:</td><td>9.6</td><td>←</td></tr> <tr><td colspan="2"><b>Series</b></td><td>91 (2x)</td></tr> <tr><td colspan="2"></td><td>448 (5x)</td></tr> </table>	41:	9.8	↖	42:	8.8	↑	43:	8.8	←	44:	10.6x	↖	45:	10.4x	↖	46:	10.1	↖	47:	9.3	↓	48:	9.8	→	49:	9.6	↓	50:	9.6	←	<b>Series</b>		91 (2x)			448 (5x)
31:	10.5x	↘																																																																									
32:	7.8	↓																																																																									
33:	9.3	→																																																																									
34:	9.2	↓																																																																									
35:	9.7	↓																																																																									
36:	8.0	↗																																																																									
37:	8.6	→																																																																									
38:	9.1	→																																																																									
39:	8.8	↖																																																																									
40:	10.5x	↑																																																																									
<b>Series</b>		87 (2x)																																																																									
		357 (3x)																																																																									
41:	9.8	↖																																																																									
42:	8.8	↑																																																																									
43:	8.8	←																																																																									
44:	10.6x	↖																																																																									
45:	10.4x	↖																																																																									
46:	10.1	↖																																																																									
47:	9.3	↓																																																																									
48:	9.8	→																																																																									
49:	9.6	↓																																																																									
50:	9.6	←																																																																									
<b>Series</b>		91 (2x)																																																																									
		448 (5x)																																																																									
<b>60 Shots</b> 	<table border="1" style="width:100%; border-collapse: collapse;"> <tr><td>51:</td><td>9.2</td><td>→</td></tr> <tr><td>52:</td><td>9.8</td><td>→</td></tr> <tr><td>53:</td><td>8.1</td><td>↓</td></tr> <tr><td>54:</td><td>10.6x</td><td>←</td></tr> <tr><td>55:</td><td>10.7x</td><td>↗</td></tr> <tr><td>56:</td><td>9.1</td><td>↑</td></tr> <tr><td>57:</td><td>9.9</td><td>↑</td></tr> <tr><td>58:</td><td>9.2</td><td>←</td></tr> <tr><td>59:</td><td>8.2</td><td>↙</td></tr> <tr><td>60:</td><td>10.1</td><td>←</td></tr> <tr><td colspan="2"><b>Series</b></td><td>91 (2x)</td></tr> <tr><td colspan="2"></td><td>539 (7x)</td></tr> </table>	51:	9.2	→	52:	9.8	→	53:	8.1	↓	54:	10.6x	←	55:	10.7x	↗	56:	9.1	↑	57:	9.9	↑	58:	9.2	←	59:	8.2	↙	60:	10.1	←	<b>Series</b>		91 (2x)			539 (7x)																																						
51:	9.2	→																																																																									
52:	9.8	→																																																																									
53:	8.1	↓																																																																									
54:	10.6x	←																																																																									
55:	10.7x	↗																																																																									
56:	9.1	↑																																																																									
57:	9.9	↑																																																																									
58:	9.2	←																																																																									
59:	8.2	↙																																																																									
60:	10.1	←																																																																									
<b>Series</b>		91 (2x)																																																																									
		539 (7x)																																																																									

Relay **2** Lane **18** **GUSTAFSON Liz**

2023 SFC Pistol Nationals AB EX WP

16.07.2023 23PN-AP-Q2 Alberta Handgun Association

Comment Signature

<p>Sight</p>	<p>1: 9.6 ↙ 2: 9.9 ↗ 3: 9.9 → 4: 10.1 ↓ 5: 6.9 ↓ 6: 9.3 ← 7: 9.0 ↓ 8: 9.3 ↓</p> <p>Series 70 (0x) 0 (0x)</p>	<p>60 Shots</p>	<p>1: 9.8 → 2: 10.9x ↗ 3: 10.1 ↓ 4: 9.0 ↓ 5: 8.7 ← 6: 10.0 ↑ 7: 8.2 ← 8: 9.5 ← 9: 9.1 ← 10: 9.3 ←</p> <p>Series 91 (1x) 91 (1x)</p>
<p>60 Shots</p>	<p>11: 9.9 ↑ 12: 9.7 ↓ 13: 10.0 ↓ 14: 8.7 ↓ 15: 10.4x ↓ 16: 9.5 ← 17: 9.8 ↗ 18: 9.3 ↓ 19: 9.9 ↗ 20: 9.4 ↑</p> <p>Series 91 (1x) 182 (2x)</p>	<p>60 Shots</p>	<p>21: 8.7 ↓ 22: 9.2 ↗ 23: 9.4 ↗ 24: 9.9 ↓ 25: 8.9 ↓ 26: 8.2 ↑ 27: 10.0 ↓ 28: 10.4x → 29: 9.8 ↓ 30: 10.2 ↙</p> <p>Series 90 (1x) 272 (3x)</p>
<p>60 Shots</p>	<p>31: 10.0 ← 32: 8.6 ↗ 33: 9.3 → 34: 9.9 ↓ 35: 10.4 ↓ 36: 9.7 ↗ 37: 9.0 ↑ 38: 9.8 → 39: 9.2 ↓ 40: 8.5 →</p> <p>Series 90 (0x) 362 (3x)</p>	<p>60 Shots</p>	<p>41: 9.4 ↑ 42: 9.5 ↓ 43: 8.7 ← 44: 10.6x ← 45: 9.7 ↑ 46: 10.7x → 47: 9.5 ← 48: 8.2 ↑ 49: 9.6 ↑ 50: 9.9 ↓</p> <p>Series 90 (2x) 452 (5x)</p>
<p>60 Shots</p>	<p>51: 9.8 ↗ 52: 10.2 ↗ 53: 8.3 ↗ 54: 10.2 ↗ 55: 9.5 ↑ 56: 10.1 ← 57: 10.0 ↓ 58: 9.7 ↓ 59: 9.7 ↗ 60: 9.6 ↙</p> <p>Series 93 (0x) 545 (5x)</p>		

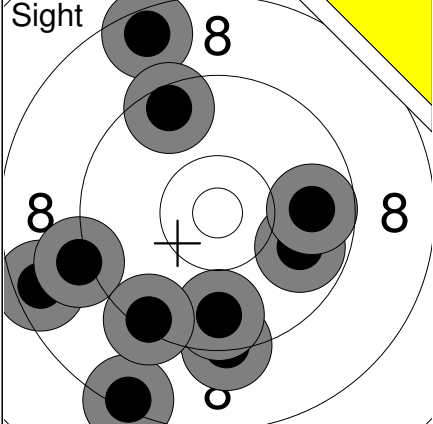
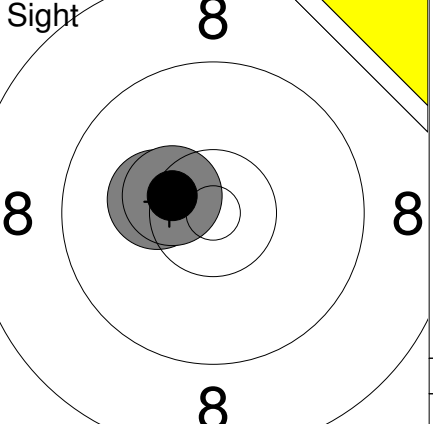
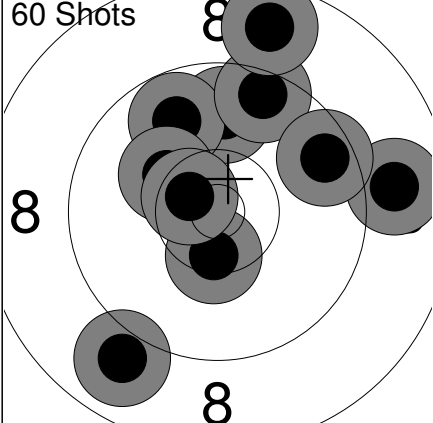
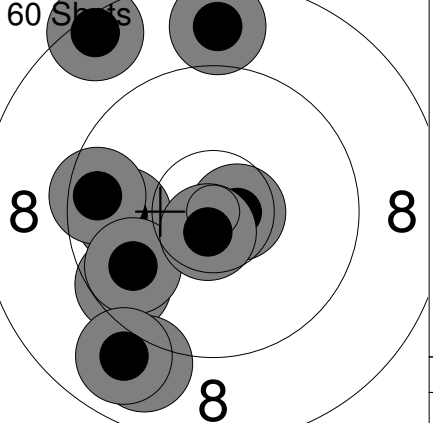
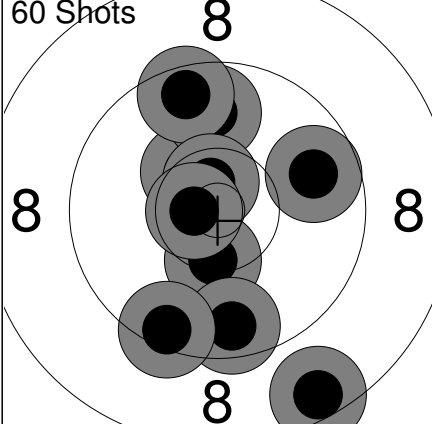
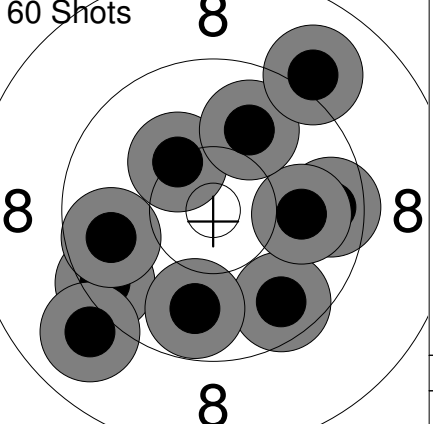
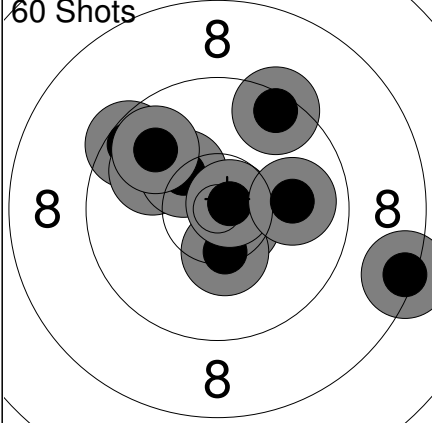
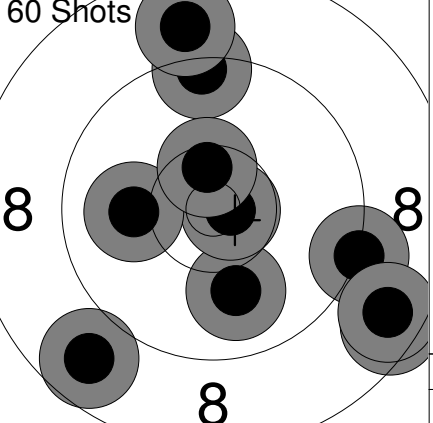
Sight 	1: 9.8 → 2: 8.5 ↗ 3: 9.8 → 4: 8.6 ← 5: 9.3 ↓ 6: 9.5 ↗ 7: 9.1 ← 8: 9.7 ↓ 9: 8.4 ↓ 10: 9.4 ↓ Series 87 (0x) 0 (0x)	Sight 	11: 10.3 ← 12: 10.4x ← Series 20 (1x) 0 (0x)
60 Shots 	1: 9.8 ↑ 2: 8.9 → 3: 9.8 ↗ 4: 10.4x ↓ 5: 10.2 ↗ 6: 9.5 ↗ 7: 9.6 → 8: 8.7 ↑ 9: 8.9 ↓ 10: 10.6x ↗ Series 90 (2x) 90 (2x)	60 Shots 	11: 9.9 ← 12: 9.6 ↙ 13: 8.4 ↗ 14: 9.6 ← 15: 10.7x → 16: 9.8 ↙ 17: 9.0 ↓ 18: 9.0 ↓ 19: 10.7x ↓ 20: 8.8 ↑ Series 90 (2x) 180 (4x)
60 Shots 	21: 10.4x ↓ 22: 10.4x ↗ 23: 9.8 → 24: 9.8 ↑ 25: 8.5 ↓ 26: 9.6 ↓ 27: 9.4 ↓ 28: 9.6 ↗ 29: 10.6x ↗ 30: 10.7x ← Series 93 (4x) 273 (8x)	60 Shots 	31: 9.5 ↙ 32: 10.3 ↗ 33: 9.0 ↙ 34: 9.6 → 35: 9.7 ← 36: 9.7 ↓ 37: 9.9 → 38: 9.9 ↗ 39: 9.0 ↗ 40: 9.8 ↓ Series 91 (0x) 364 (8x)
60 Shots 	41: 9.5 ↗ 42: 10.0 ↗ 43: 10.3 ↗ 44: 10.6x ↓ 45: 9.8 ↗ 46: 10.4x ↓ 47: 10.8x → 48: 9.5 ↗ 49: 8.4 ↓ 50: 10.0 → Series 95 (3x) 459 (11x)	60 Shots 	51: 10.0 ↓ 52: 10.8x → 53: 9.4 ↑ 54: 9.2 → 55: 10.0 ← 56: 10.5x ↑ 57: 8.5 ↘ 58: 8.9 ↑ 59: 8.7 ↙ 60: 8.6 ↘ Series 90 (2x) 549 (13x)



Sight 	1: 8.9 ↓ 2: 10.4 ↗ 3: 8.7 ↓ 4: 8.9 ↓ 5: 10.0 ↗ 6: 9.0 → 7: 9.1 → 8: 10.0 ↗ 9: 10.3 ↑ 10: 8.9 ↗ <hr/> Series 90 (0x) 0 (0x)	Sight 	11: 10.1 ↗ 12: 8.0 ↘ 13: 10.0 ← 14: 8.6 ↑ 15: 8.2 ↑ 16: 8.1 ↑ 17: 8.8 ↓ 18: 8.1 ↑ 19: 9.4 ↓ 20: 9.5 ← <hr/> Series 86 (0x) 0 (0x)
-----------	---	-----------	--

Sight 	21: 9.5 ↑ 22: 10.3 ↓ 23: 10.3 ↗ 24: 10.4x → <hr/> Series 39 (1x) 0 (0x)	60 Shots 	1: 8.6 ↓ 2: 9.2 ↑ 3: 9.9 ← 4: 7.5 ← 5: 9.6 ↗ 6: 9.5 ↓ 7: 7.9 ← 8: 8.5 ↗ 9: 9.7 ← 10: 8.1 → <hr/> Series 83 (0x) 83 (0x)
-----------	--	--------------	--

60 Shots 	11: 10.1 → 12: 9.4 ↘ 13: 9.2 ↘ 14: 9.8 ← 15: 7.3 ↑ 16: 9.6 ↗ 17: 8.9 ↑ 18: 9.8 ← 19: 8.4 ↗ 20: 7.9 ← <hr/> Series 85 (0x) 168 (0x)	60 Shots 	21: 8.9 → 22: 10.0 ↖ 23: 10.1 ← 24: 10.3 ↑ 25: 9.4 ↑ 26: 10.0 ↗ 27: 10.5x ↓ 28: 8.7 ↓ 29: 9.9 ↓ 30: 9.8 ↖ <hr/> Series 93 (1x) 261 (1x)
--------------	---	--------------	--

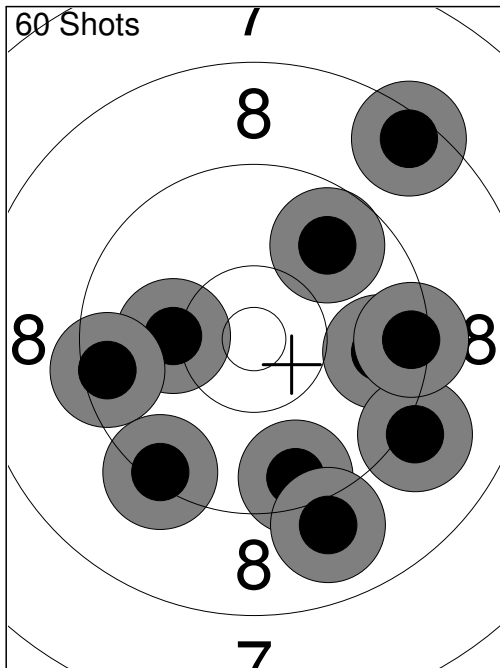

31:	9.5	↓
32:	10.2	←
33:	8.5	↗
34:	9.0	↓
35:	9.5	←
36:	9.7	→
37:	9.1	↘
38:	9.4	↓
39:	9.4	→
40:	9.8	↗
Series	90 ( 0x)	
	351 ( 1x)	

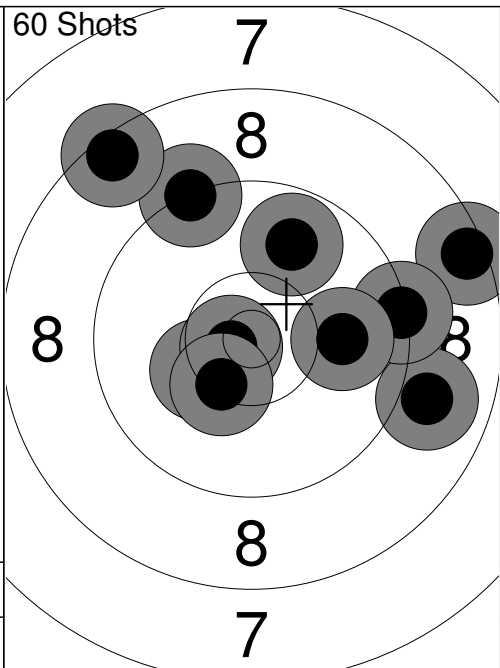

41:	10.3	↙
42:	9.8	↗
43:	9.3	↗
44:	8.4	↖
45:	8.4	→
46:	8.9	→
47:	9.3	→
48:	10.7x	↙
49:	10.4x	↘
50:	10.0	→
Series	91 ( 2x)	
	442 ( 3x)	

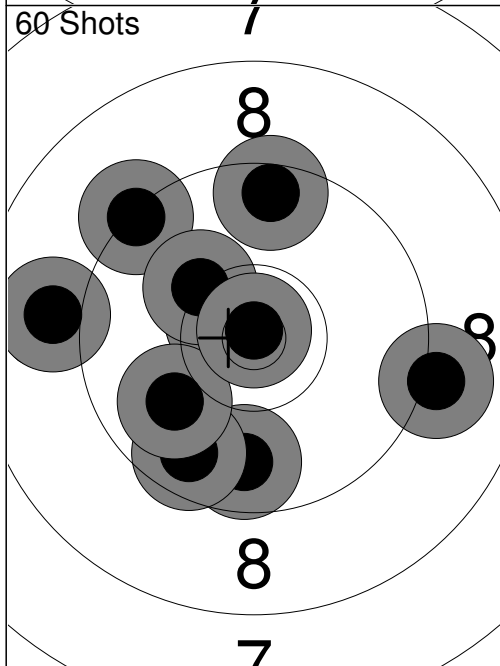

51:	9.7	↓
52:	9.0	←
53:	10.6x	↙
54:	9.7	↓
55:	9.3	↖
56:	9.5	↑
57:	10.0	↙
58:	9.1	→
59:	10.2	↖
60:	10.9x	↑
Series	94 ( 2x)	
	536 ( 5x)	

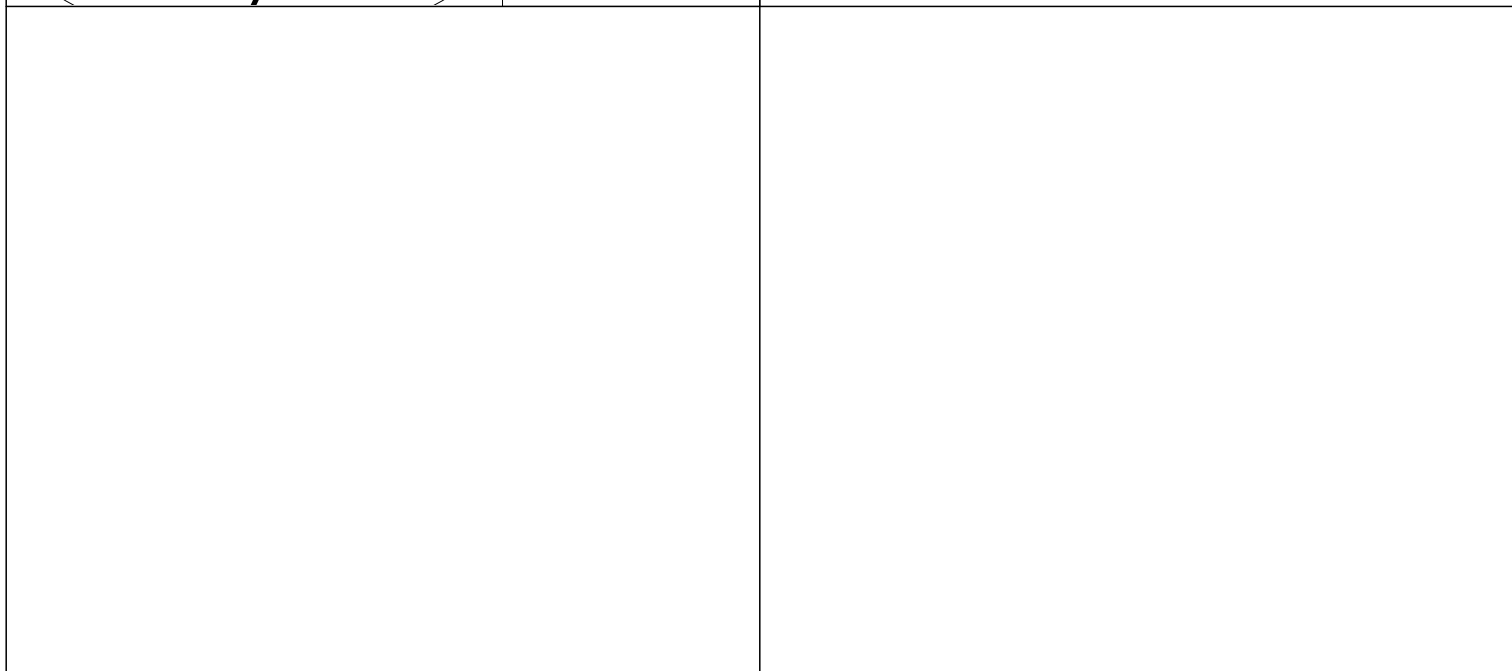

Relay **2** Lane **21** **XU Helen**

2023 SFC Pistol Nationals BC IJ WP

16.07.2023 23PN-AP-Q2 Alberta Handgun Association

Comment Signature

	1: 10.1 ↗		1: 7.9 ←
	2: 9.5 ↗		2: 9.9 ↗
	3: 8.4 →		3: 9.2 ↓
	4: 8.9 ↓		4: 9.2 ↗
	5: 10.5x ←		5: 9.3 ↖
	6: 7.7 →		6: 9.5 ←
	7: 8.6 →		7: 9.6 ↖
	8: 8.7 ←		8: 10.4x ↗
	9: 8.4 ↗		9: 10.0 ↓
	10: 9.9 ↗		10: 10.5x ↑
	Series 85 (1x)		Series 91 (2x)
	0 (0x)		91 (2x)

	11: 7.3 ↓		21: 7.9 ↗
	12: 10.4x ↑		22: 8.5 ↗
	13: 8.3 ↓		23: 9.0 ←
	14: 9.4 ↓		24: 7.2 ↑
	15: 7.8 ↗		25: 7.8 →
	16: 10.2 ←		26: 9.2 ↗
	17: 9.5 ↗		27: 8.2 ↗
	18: 9.4 ↓		28: 9.6 ←
	19: 9.3 ↑		29: 9.6 ←
	20: 10.7x ↗		30: 6.7 ↑
	Series 88 (2x)		Series 79 (0x)
	179 (4x)		258 (4x)

	31: 8.6 ↑		41: 8.3 ↖
	32: 9.7 ←		42: 9.7 ←
	33: 8.7 ↗		43: 10.2 ↖
	34: 8.8 ↑		44: 9.5 ↗
	35: 10.4x ↓		45: 8.7 ↖
	36: 7.6 ↑		46: 9.2 ↑
	37: 9.0 ↓		47: 9.6 ↑
	38: 9.3 ↗		48: 9.0 →
	39: 8.8 ↗		49: 9.8 →
	40: 10.3 ↗		50: 9.7 ↑
	Series 86 (1x)		Series 89 (0x)
	344 (5x)		433 (5x)

	51: 8.6 ↑	
	52: 9.6 ↗	
	53: 8.5 ↑	
	54: 9.3 ↗	
	55: 9.0 ←	
	56: 10.3 ↓	
	57: 9.8 ↑	
	58: 9.2 ←	
	59: 8.8 →	
	60: 8.0 ↑	
	Series 87 (0x)	
	520 (5x)	

Relay **2** Lane **22** **LIU Nina jia rui**

2023 SFC Pistol Nationals BC JR WP

16.07.2023 23PN-AP-Q2 Alberta Handgun Association

Comment Signature

Sight 	1: 10.0 ↑	Sight 	11: 8.1 →
	2: 7.0 ↗		12: 8.6 ↘
	3: 9.8 →		13: 9.5 →
	4: 9.3 ↗		14: 9.0 ↗
	5: 7.6 ↖		15: 8.6 ↑
	6: 7.5 ↗		16: 8.6 ↘
	7: 10.1 ↘		
	8: 6.0 ↑		
	9: 7.4 ↖		
	10: 8.1 ↗		
Series	80 (0x)	Series	50 (0x)
	0 (0x)		0 (0x)

60 Shots 	1: 10.2 →	60 Shots 	11: 9.8 ↗
	2: 10.1 ↗		12: 8.3 ←
	3: 8.4 ↖		13: 9.6 →
	4: 8.5 ←		14: 7.0 ←
	5: 10.7x ↘		15: 10.8x →
	6: 8.9 ↖		16: 8.9 ↑
	7: 8.2 ↖		17: 7.1 ↑
	8: 8.1 ↗		18: 7.7 ←
	9: 7.6 ↗		19: 10.3 ↖
	10: 6.3 ↑		20: 9.6 ↘
Series	83 (1x)	Series	84 (1x)
	83 (1x)		167 (2x)

60 Shots 	21: 9.8 ←	60 Shots 	31: 8.8 ↘
	22: 7.5 →		32: 9.8 ←
	23: 6.9 ↗		33: 8.3 →
	24: 10.1 ↗		34: 9.6 ↗
	25: 6.6 ↗		35: 6.1 ↑
	26: 7.1 ↑		36: 9.2 ↘
	27: 10.3 ←		37: 5.9 ↗
	28: 6.1 ↗		38: 9.8 ↗
	29: 8.9 ↘		39: 9.4 ←
	30: 7.8 ↑		40: 8.9 ←
Series	76 (0x)	Series	80 (0x)
	243 (2x)		323 (2x)

60 Shots 	41: 4.2 ↗	60 Shots 	51: 9.1 ←
	42: 10.5x ↗		52: 8.7 →
	43: 10.5x ←		53: 8.9 ↗
	44: 8.2 ↗		54: 7.0 →
	45: 7.2 ↖		55: 7.6 ↗
	46: 9.9 ↗		56: 8.5 ↑
	47: 1.3 ↑		57: 6.3 ↗
	48: 8.6 →		58: 10.3 ↘
	49: 10.2 ↘		59: 7.2 ↑
	50: 9.8 →		60: 0.0 ↑
Series	76 (2x)	Series	70 (0x)
	399 (4x)		469 (4x)

Relay <b>2</b>	Lane <b>23</b>	<b>HAN Kally</b>
-------------------	-------------------	------------------

2023 SFC Pistol Nationals	BC	JR	WP
---------------------------	----	----	----

16.07.2023	23PN-AP-Q2	Alberta Handgun Association
------------	------------	-----------------------------

Comment	Signature
---------	-----------

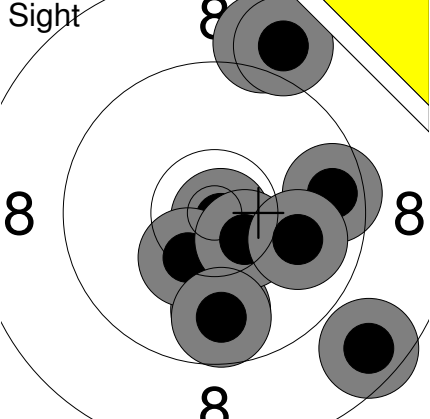
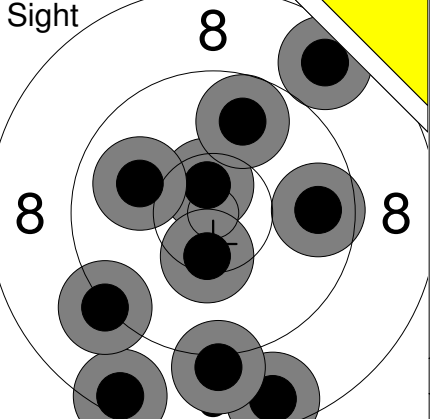
	1: 10.9x ↘ 2: 9.6 → 3: 9.8 ↓ 4: 8.9 ↑ 5: 8.6 ↓ 6: 10.4x ↙ 7: 8.9 ↑ 8: 10.5x ↓ 9: 9.8 ↓ 10: 10.0 → Series 91 (3x) 0 (0x)		11: 8.5 ↘ 12: 9.2 ↙ 13: 10.6x ↑ 14: 10.4x ↓ 15: 9.7 → 16: 8.6 ↓ 17: 9.1 ↓ 18: 10.0 ↖ 19: 8.7 ↗ 20: 9.8 ↑ Series 90 (2x) 0 (0x)
--	--	--	---

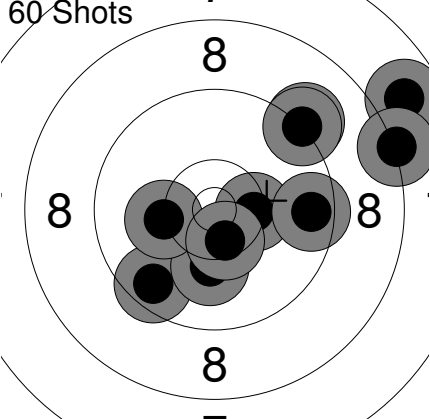
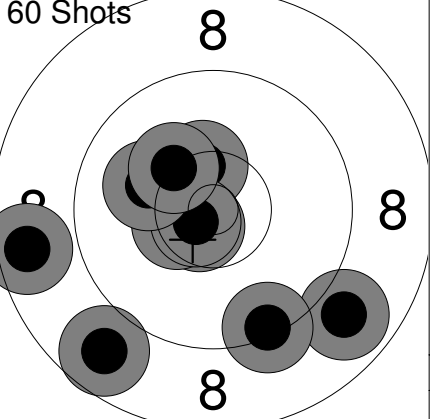
	1: 9.6 ↙ 2: 10.1 ↓ 3: 9.1 ↗ 4: 7.8 ↗ 5: 10.4x → 6: 8.2 → 7: 9.6 → 8: 10.2 ← 9: 10.5x ↓ 10: 9.2 ↗ Series 91 (2x) 91 (2x)		11: 10.7x ↙ 12: 10.5x ← 13: 8.9 ↘ 14: 10.4x ↑ 15: 8.6 ← 16: 10.7x ↙ 17: 10.1 ↖ 18: 8.7 ↙ 19: 10.2 ↗ 20: 9.3 ↓ Series 93 (4x) 184 (6x)
---	--	---	--

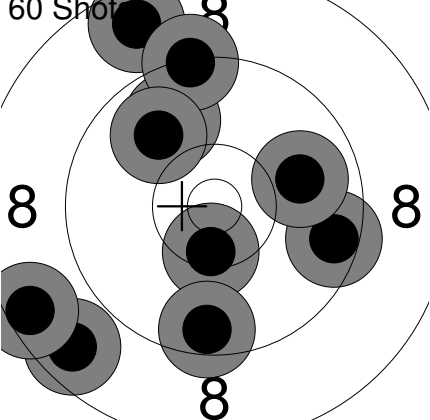
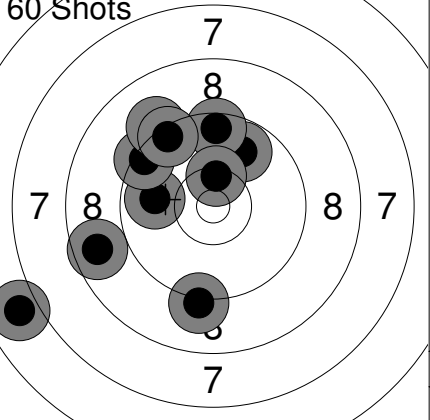
	21: 9.8 ↗ 22: 9.5 → 23: 10.4x ↓ 24: 8.7 ↗ 25: 9.5 ↓ 26: 9.3 ↑ 27: 9.9 → 28: 8.6 ↙ 29: 8.5 ↙ 30: 9.9 ↗ Series 88 (1x) 272 (7x)		31: 9.8 ↗ 32: 9.9 ← 33: 9.4 ↗ 34: 9.5 ↑ 35: 6.9 ← 36: 9.1 ↗ 37: 9.1 ↓ 38: 10.4x ↑ 39: 8.7 ← 40: 9.4 ↗ Series 87 (1x) 359 (8x)
--	--	--	--

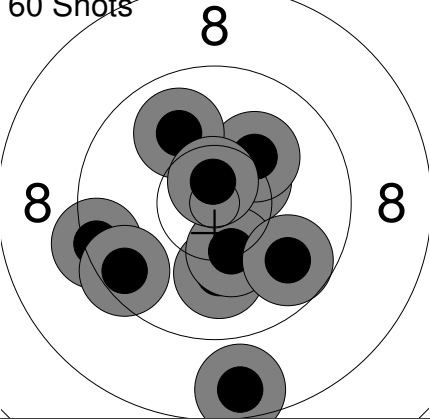
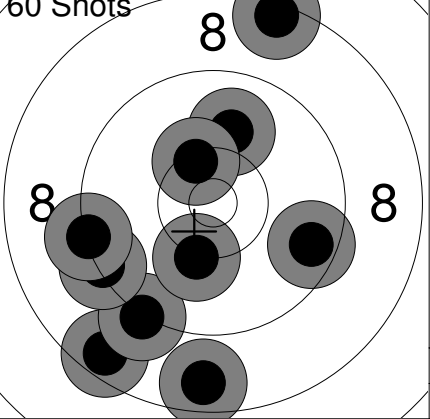
	41: 9.4 ← 42: 10.1 ↓ 43: 10.5x ↗ 44: 10.3 ↓ 45: 10.2 ↗ 46: 9.5 ↙ 47: 9.8 ↘ 48: 10.0 ↗ 49: 8.6 ↓ 50: 10.7x ↑ Series 95 (2x) 454 (10x)		51: 10.0 ↑ 52: 8.5 ↙ 53: 10.4x ↗ 54: 9.2 ↓ 55: 9.3 ← 56: 9.6 → 57: 8.4 ↑ 58: 10.2 ↓ 59: 8.6 ↓ 60: 9.3 ← Series 90 (1x) 544 (11x)
--	---	--	---

Relay **2** Lane **24** **NICOL Sophia ting**

2023 SFC Pistol Nationals BC SJ WP

16.07.2023 23PN-AP-Q2 Alberta Handgun Association

Comment Signature

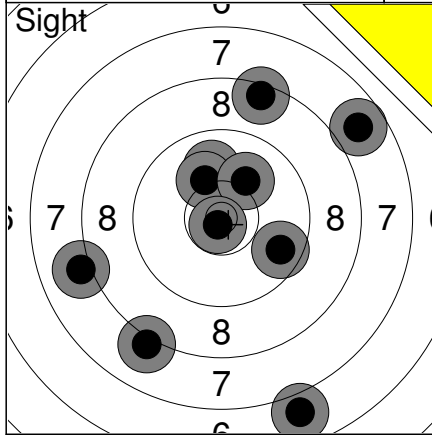

1:	8.4	↑
2:	6.9	↓
3:	8.1	↓
4:	9.6	→
5:	10.0	↑
6:	7.8	↗
7:	10.1	↑
8:	10.1	↗
9:	8.0	←
10:	10.8x	↓
Series	86 (1x)	
	0 (0x)	

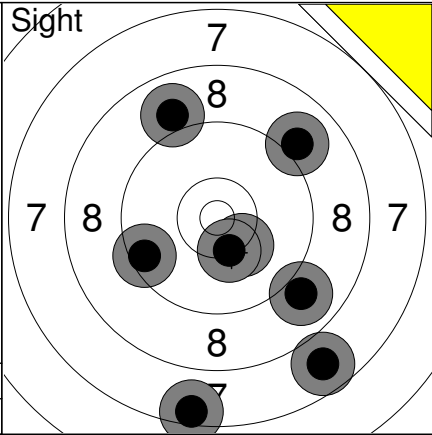

11:	10.3	↓
12:	9.5	←
13:	9.0	↗
14:	8.9	↘
15:	7.7	↓
16:	10.3	↓
17:	7.5	↓
18:	9.0	↗
Series	69 (0x)	
	0 (0x)	

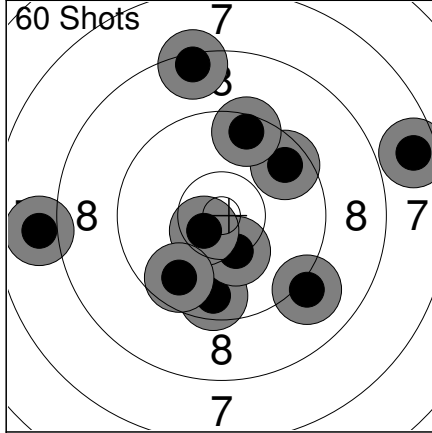

1:	7.9	←
2:	9.6	↓
3:	10.3	↓
4:	9.6	↗
5:	10.6x	←
6:	7.6	→
7:	9.7	↓
8:	9.1	↘
9:	9.5	↑
10:	8.4	↑
Series	87 (1x)	
	87 (1x)	

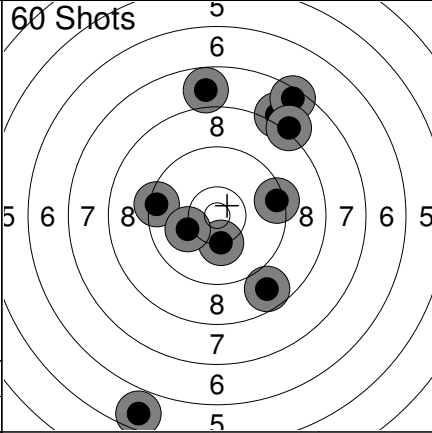

11:	8.0	↗
12:	9.4	←
13:	10.3	↓
14:	7.8	↑
15:	7.5	↗
16:	9.4	→
17:	10.1	←
18:	8.7	↓
19:	8.1	↗
20:	5.6	↓
Series	81 (0x)	
	168 (1x)	

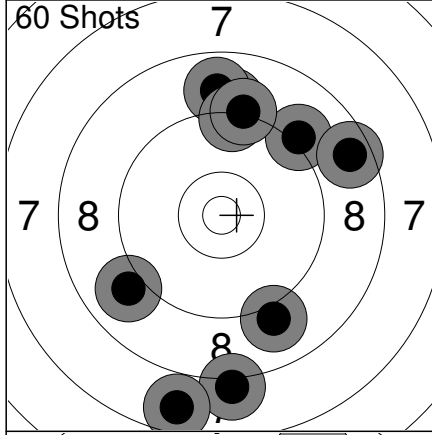

21:	9.0	↑
22:	8.9	↑
23:	8.1	↓
24:	7.7	↓
25:	9.3	↑
26:	9.1	↗
27:	9.0	↓
28:	9.0	←
29:	9.2	↑
30:	8.6	→
Series	85 (0x)	
	253 (1x)	

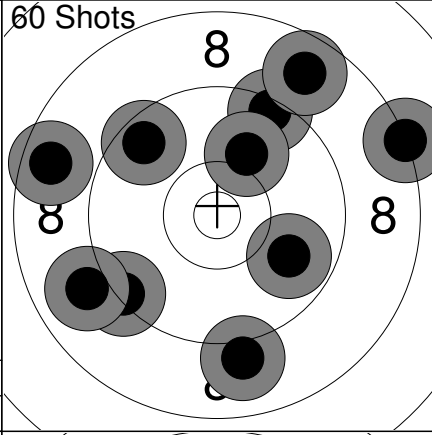

31:	8.6	←
32:	9.4	↗
33:	8.7	↗
34:	9.3	←
35:	9.8	↘
36:	9.0	←
37:	9.0	↓
38:	10.0	↗
39:	8.2	→
40:	9.6	↖
Series	88 (0x)	
	341 (1x)	

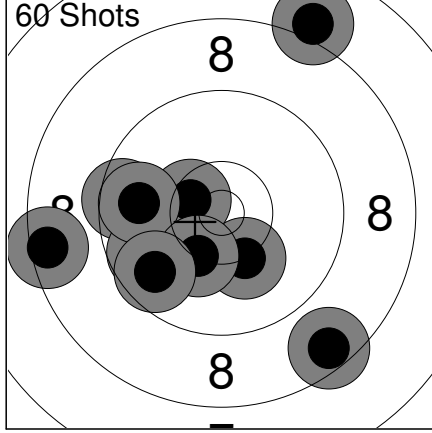

41:	10.2	↓
42:	9.6	←
43:	8.5	←
44:	9.8	←
45:	10.5x	←
46:	9.8	←
47:	10.3	↓
48:	9.7	←
49:	8.0	↗
50:	8.5	↓
Series	90 (1x)	
	431 (2x)	

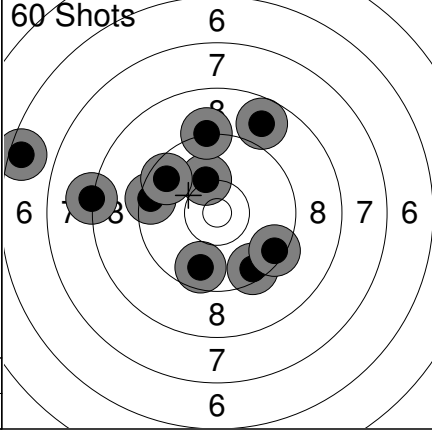

51:	9.7	↓
52:	9.5	↓
53:	8.8	↗
54:	8.2	←
55:	9.5	←
56:	10.2	↗
57:	9.6	↗
58:	6.5	←
59:	9.2	↑
60:	9.5	↘
Series	86 (0x)	
	517 (2x)	



Relay **2** Lane **25** **ZHANG Sissi yinhan**

2023 SFC Pistol Nationals BC SJ WP

16.07.2023 23PN-AP-Q2 Alberta Handgun Association

Comment Signature

<p>Sight</p>	<p>1: 8.0 → 2: 7.8 ↓ 3: 8.6 ↙ 4: 10.4x → 5: 8.4 ↑ 6: 7.3 ← 7: 7.0 ↗ 8: 9.5 ← 9: 7.9 ↓ 10: 6.3 ↑</p> <p>Series 77 (1x) 0 (0x)</p>	<p>Sight</p>	<p>11: 10.2 ↑ 12: 9.0 ← 13: 8.7 ↗ 14: 9.7 ←</p> <p>Series 36 (0x) 0 (0x)</p>
<p>60 Shots</p>	<p>1: 9.6 ← 2: 9.7 ← 3: 9.3 ↓ 4: 9.9 ↗ 5: 9.3 ↓ 6: 9.9 ← 7: 9.0 ↓ 8: 7.7 ↑ 9: 8.2 ↓ 10: 9.8 →</p> <p>Series 87 (0x) 87 (0x)</p>	<p>60 Shots</p>	<p>11: 7.0 ↗ 12: 8.7 ← 13: 6.0 ↓ 14: 7.5 ↗ 15: 9.2 ← 16: 10.4x ↘ 17: 9.0 ← 18: 6.9 ← 19: 10.1 ↗ 20: 9.3 →</p> <p>Series 81 (1x) 168 (1x)</p>
<p>60 Shots</p>	<p>21: 8.7 ↓ 22: 6.5 ← 23: 7.0 ← 24: 8.5 ← 25: 8.7 ← 26: 9.1 ↑ 27: 9.4 ← 28: 7.5 ← 29: 6.3 ← 30: 8.2 ↑</p> <p>Series 76 (0x) 244 (1x)</p>	<p>60 Shots</p>	<p>31: 7.3 ↓ 32: 10.6x ↙ 33: 9.4 ↓ 34: 9.7 ↓ 35: 10.6x ↗ 36: 9.0 ↓ 37: 10.3 ← 38: 7.9 ↑ 39: 9.2 ↗ 40: 9.0 ↓</p> <p>Series 89 (2x) 333 (3x)</p>
<p>60 Shots</p>	<p>41: 7.9 ← 42: 9.0 ← 43: 7.6 ← 44: 9.9 ↗ 45: 8.6 ↑ 46: 8.9 ↑ 47: 9.0 ↑ 48: 8.9 ↗ 49: 10.5x ↑ 50: 10.4 ←</p> <p>Series 85 (1x) 418 (4x)</p>	<p>60 Shots</p>	<p>51: 9.5 ↘ 52: 8.0 ← 53: 8.3 ↓ 54: 8.5 ↗ 55: 7.4 ← 56: 10.2 ↓ 57: 7.6 ↑ 58: 5.8 ← 59: 8.6 ↗ 60: 8.4 ↗</p> <p>Series 78 (0x) 496 (4x)</p>

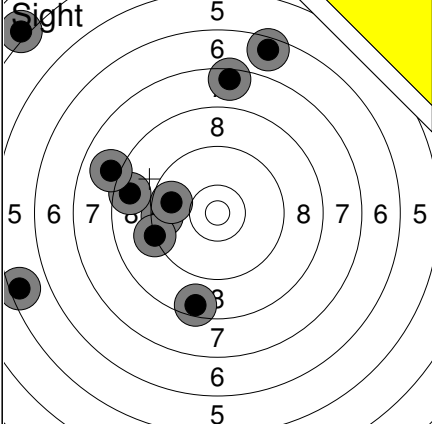
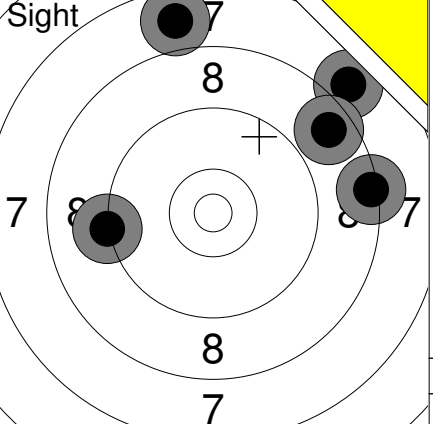
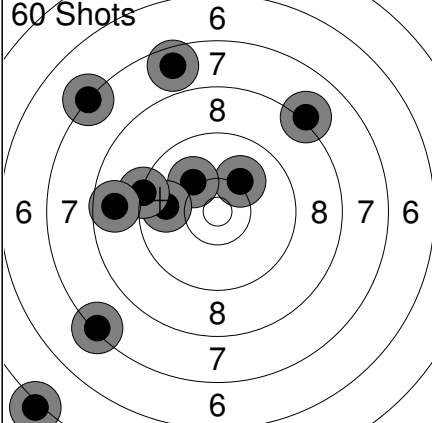
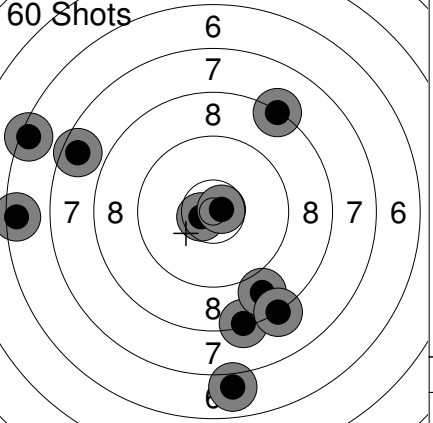
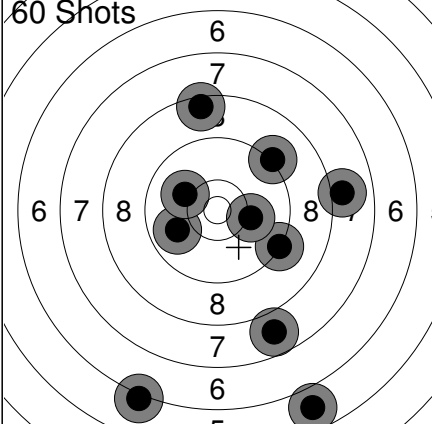
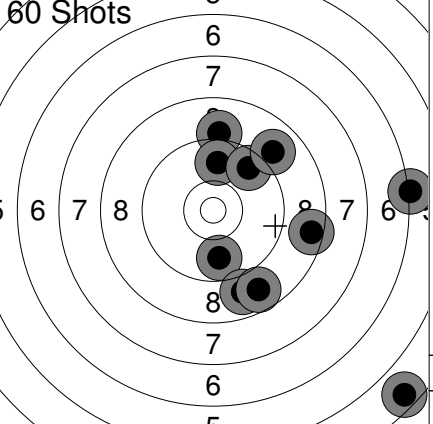
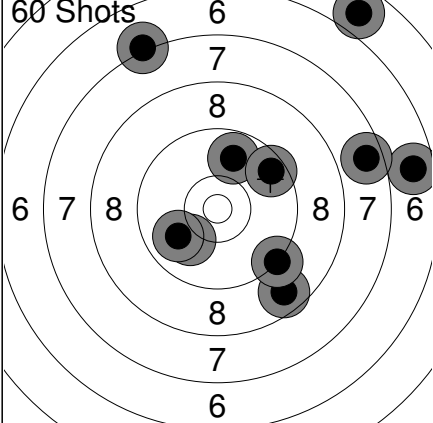
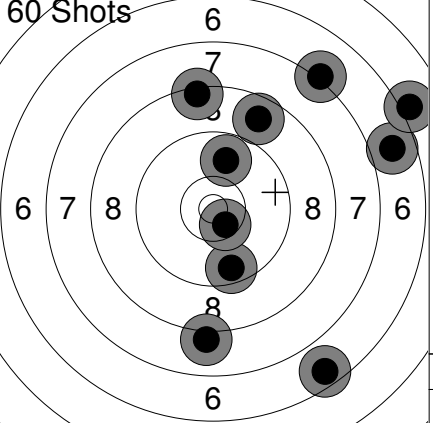
Sight 	<table border="1" style="width:100%; border-collapse: collapse;"> <tr><td>1:</td><td>4.1</td><td>↖</td></tr> <tr><td>2:</td><td>7.5</td><td>↑</td></tr> <tr><td>3:</td><td>9.5</td><td>←</td></tr> <tr><td>4:</td><td>8.6</td><td>←</td></tr> <tr><td>5:</td><td>8.0</td><td>↖</td></tr> <tr><td>6:</td><td>5.5</td><td>←</td></tr> <tr><td>7:</td><td>9.2</td><td>←</td></tr> <tr><td>8:</td><td>8.5</td><td>↓</td></tr> <tr><td>9:</td><td>6.5</td><td>↑</td></tr> <tr><td>10:</td><td>9.7</td><td>←</td></tr> <tr><td colspan="2">Series</td><td>73 (0x)</td></tr> <tr><td colspan="2"></td><td>0 (0x)</td></tr> </table>	1:	4.1	↖	2:	7.5	↑	3:	9.5	←	4:	8.6	←	5:	8.0	↖	6:	5.5	←	7:	9.2	←	8:	8.5	↓	9:	6.5	↑	10:	9.7	←	Series		73 (0x)			0 (0x)	Sight 	<table border="1" style="width:100%; border-collapse: collapse;"> <tr><td>11:</td><td>7.8</td><td>↑</td></tr> <tr><td>12:</td><td>7.9</td><td>↗</td></tr> <tr><td>13:</td><td>8.6</td><td>↗</td></tr> <tr><td>14:</td><td>8.3</td><td>→</td></tr> <tr><td>15:</td><td>9.2</td><td>←</td></tr> <tr><td colspan="2">Series</td><td>39 (0x)</td></tr> <tr><td colspan="2"></td><td>0 (0x)</td></tr> </table>	11:	7.8	↑	12:	7.9	↗	13:	8.6	↗	14:	8.3	→	15:	9.2	←	Series		39 (0x)			0 (0x)															
1:	4.1	↖																																																																									
2:	7.5	↑																																																																									
3:	9.5	←																																																																									
4:	8.6	←																																																																									
5:	8.0	↖																																																																									
6:	5.5	←																																																																									
7:	9.2	←																																																																									
8:	8.5	↓																																																																									
9:	6.5	↑																																																																									
10:	9.7	←																																																																									
Series		73 (0x)																																																																									
		0 (0x)																																																																									
11:	7.8	↑																																																																									
12:	7.9	↗																																																																									
13:	8.6	↗																																																																									
14:	8.3	→																																																																									
15:	9.2	←																																																																									
Series		39 (0x)																																																																									
		0 (0x)																																																																									
60 Shots 	<table border="1" style="width:100%; border-collapse: collapse;"> <tr><td>1:</td><td>10.1</td><td>↗</td></tr> <tr><td>2:</td><td>10.1</td><td>↗</td></tr> <tr><td>3:</td><td>7.3</td><td>↖</td></tr> <tr><td>4:</td><td>8.1</td><td>↗</td></tr> <tr><td>5:</td><td>7.6</td><td>↑</td></tr> <tr><td>6:</td><td>9.8</td><td>←</td></tr> <tr><td>7:</td><td>7.2</td><td>↗</td></tr> <tr><td>8:</td><td>9.3</td><td>←</td></tr> <tr><td>9:</td><td>5.1</td><td>↖</td></tr> <tr><td>10:</td><td>8.7</td><td>←</td></tr> <tr><td colspan="2">Series</td><td>80 (0x)</td></tr> <tr><td colspan="2"></td><td>80 (0x)</td></tr> </table>	1:	10.1	↗	2:	10.1	↗	3:	7.3	↖	4:	8.1	↗	5:	7.6	↑	6:	9.8	←	7:	7.2	↗	8:	9.3	←	9:	5.1	↖	10:	8.7	←	Series		80 (0x)			80 (0x)	60 Shots 	<table border="1" style="width:100%; border-collapse: collapse;"> <tr><td>11:</td><td>10.6x</td><td>←</td></tr> <tr><td>12:</td><td>8.3</td><td>↓</td></tr> <tr><td>13:</td><td>8.3</td><td>↗</td></tr> <tr><td>14:</td><td>8.8</td><td>↓</td></tr> <tr><td>15:</td><td>6.4</td><td>↖</td></tr> <tr><td>16:</td><td>6.5</td><td>←</td></tr> <tr><td>17:</td><td>7.6</td><td>↖</td></tr> <tr><td>18:</td><td>8.2</td><td>↓</td></tr> <tr><td>19:</td><td>6.9</td><td>↓</td></tr> <tr><td>20:</td><td>10.7x</td><td>→</td></tr> <tr><td colspan="2">Series</td><td>77 (2x)</td></tr> <tr><td colspan="2"></td><td>157 (2x)</td></tr> </table>	11:	10.6x	←	12:	8.3	↓	13:	8.3	↗	14:	8.8	↓	15:	6.4	↖	16:	6.5	←	17:	7.6	↖	18:	8.2	↓	19:	6.9	↓	20:	10.7x	→	Series		77 (2x)			157 (2x)
1:	10.1	↗																																																																									
2:	10.1	↗																																																																									
3:	7.3	↖																																																																									
4:	8.1	↗																																																																									
5:	7.6	↑																																																																									
6:	9.8	←																																																																									
7:	7.2	↗																																																																									
8:	9.3	←																																																																									
9:	5.1	↖																																																																									
10:	8.7	←																																																																									
Series		80 (0x)																																																																									
		80 (0x)																																																																									
11:	10.6x	←																																																																									
12:	8.3	↓																																																																									
13:	8.3	↗																																																																									
14:	8.8	↓																																																																									
15:	6.4	↖																																																																									
16:	6.5	←																																																																									
17:	7.6	↖																																																																									
18:	8.2	↓																																																																									
19:	6.9	↓																																																																									
20:	10.7x	→																																																																									
Series		77 (2x)																																																																									
		157 (2x)																																																																									
60 Shots 	<table border="1" style="width:100%; border-collapse: collapse;"> <tr><td>21:</td><td>9.2</td><td>↗</td></tr> <tr><td>22:</td><td>9.2</td><td>↘</td></tr> <tr><td>23:</td><td>8.0</td><td>→</td></tr> <tr><td>24:</td><td>6.1</td><td>↓</td></tr> <tr><td>25:</td><td>9.9</td><td>←</td></tr> <tr><td>26:</td><td>10.1</td><td>→</td></tr> <tr><td>27:</td><td>8.5</td><td>↑</td></tr> <tr><td>28:</td><td>7.8</td><td>↓</td></tr> <tr><td>29:</td><td>5.8</td><td>↓</td></tr> <tr><td>30:</td><td>10.1</td><td>↖</td></tr> <tr><td colspan="2">Series</td><td>81 (0x)</td></tr> <tr><td colspan="2"></td><td>238 (2x)</td></tr> </table>	21:	9.2	↗	22:	9.2	↘	23:	8.0	→	24:	6.1	↓	25:	9.9	←	26:	10.1	→	27:	8.5	↑	28:	7.8	↓	29:	5.8	↓	30:	10.1	↖	Series		81 (0x)			238 (2x)	60 Shots 	<table border="1" style="width:100%; border-collapse: collapse;"> <tr><td>31:</td><td>9.1</td><td>↑</td></tr> <tr><td>32:</td><td>4.6</td><td>↘</td></tr> <tr><td>33:</td><td>9.8</td><td>↓</td></tr> <tr><td>34:</td><td>8.9</td><td>↓</td></tr> <tr><td>35:</td><td>9.8</td><td>↑</td></tr> <tr><td>36:</td><td>8.7</td><td>↓</td></tr> <tr><td>37:</td><td>9.6</td><td>↗</td></tr> <tr><td>38:</td><td>6.2</td><td>→</td></tr> <tr><td>39:</td><td>8.5</td><td>→</td></tr> <tr><td>40:</td><td>8.9</td><td>↗</td></tr> <tr><td colspan="2">Series</td><td>78 (0x)</td></tr> <tr><td colspan="2"></td><td>316 (2x)</td></tr> </table>	31:	9.1	↑	32:	4.6	↘	33:	9.8	↓	34:	8.9	↓	35:	9.8	↑	36:	8.7	↓	37:	9.6	↗	38:	6.2	→	39:	8.5	→	40:	8.9	↗	Series		78 (0x)			316 (2x)
21:	9.2	↗																																																																									
22:	9.2	↘																																																																									
23:	8.0	→																																																																									
24:	6.1	↓																																																																									
25:	9.9	←																																																																									
26:	10.1	→																																																																									
27:	8.5	↑																																																																									
28:	7.8	↓																																																																									
29:	5.8	↓																																																																									
30:	10.1	↖																																																																									
Series		81 (0x)																																																																									
		238 (2x)																																																																									
31:	9.1	↑																																																																									
32:	4.6	↘																																																																									
33:	9.8	↓																																																																									
34:	8.9	↓																																																																									
35:	9.8	↑																																																																									
36:	8.7	↓																																																																									
37:	9.6	↗																																																																									
38:	6.2	→																																																																									
39:	8.5	→																																																																									
40:	8.9	↗																																																																									
Series		78 (0x)																																																																									
		316 (2x)																																																																									
60 Shots 	<table border="1" style="width:100%; border-collapse: collapse;"> <tr><td>41:</td><td>9.8</td><td>↑</td></tr> <tr><td>42:</td><td>8.7</td><td>↘</td></tr> <tr><td>43:</td><td>10.1</td><td>↖</td></tr> <tr><td>44:</td><td>9.2</td><td>↘</td></tr> <tr><td>45:</td><td>5.8</td><td>↗</td></tr> <tr><td>46:</td><td>6.7</td><td>→</td></tr> <tr><td>47:</td><td>9.5</td><td>↗</td></tr> <tr><td>48:</td><td>9.9</td><td>←</td></tr> <tr><td>49:</td><td>7.6</td><td>→</td></tr> <tr><td>50:</td><td>7.2</td><td>↑</td></tr> <tr><td colspan="2">Series</td><td>79 (0x)</td></tr> <tr><td colspan="2"></td><td>395 (2x)</td></tr> </table>	41:	9.8	↑	42:	8.7	↘	43:	10.1	↖	44:	9.2	↘	45:	5.8	↗	46:	6.7	→	47:	9.5	↗	48:	9.9	←	49:	7.6	→	50:	7.2	↑	Series		79 (0x)			395 (2x)	60 Shots 	<table border="1" style="width:100%; border-collapse: collapse;"> <tr><td>51:</td><td>9.6</td><td>↓</td></tr> <tr><td>52:</td><td>8.4</td><td>↑</td></tr> <tr><td>53:</td><td>6.7</td><td>→</td></tr> <tr><td>54:</td><td>8.0</td><td>↓</td></tr> <tr><td>55:</td><td>6.6</td><td>↓</td></tr> <tr><td>56:</td><td>8.7</td><td>↗</td></tr> <tr><td>57:</td><td>7.2</td><td>↗</td></tr> <tr><td>58:</td><td>6.0</td><td>↗</td></tr> <tr><td>59:</td><td>10.5x</td><td>↘</td></tr> <tr><td>60:</td><td>9.8</td><td>↑</td></tr> <tr><td colspan="2">Series</td><td>77 (1x)</td></tr> <tr><td colspan="2"></td><td>472 (3x)</td></tr> </table>	51:	9.6	↓	52:	8.4	↑	53:	6.7	→	54:	8.0	↓	55:	6.6	↓	56:	8.7	↗	57:	7.2	↗	58:	6.0	↗	59:	10.5x	↘	60:	9.8	↑	Series		77 (1x)			472 (3x)
41:	9.8	↑																																																																									
42:	8.7	↘																																																																									
43:	10.1	↖																																																																									
44:	9.2	↘																																																																									
45:	5.8	↗																																																																									
46:	6.7	→																																																																									
47:	9.5	↗																																																																									
48:	9.9	←																																																																									
49:	7.6	→																																																																									
50:	7.2	↑																																																																									
Series		79 (0x)																																																																									
		395 (2x)																																																																									
51:	9.6	↓																																																																									
52:	8.4	↑																																																																									
53:	6.7	→																																																																									
54:	8.0	↓																																																																									
55:	6.6	↓																																																																									
56:	8.7	↗																																																																									
57:	7.2	↗																																																																									
58:	6.0	↗																																																																									
59:	10.5x	↘																																																																									
60:	9.8	↑																																																																									
Series		77 (1x)																																																																									
		472 (3x)																																																																									

Relay <b>2</b>	Lane <b>28</b>	<b>XU Kitty</b>
-------------------	-------------------	-----------------

2023 SFC Pistol Nationals BC	SJ	WP
------------------------------	----	----

16.07.2023	23PN-AP-Q2	Alberta Handgun Association
------------	------------	-----------------------------

Comment	Signature
---------	-----------

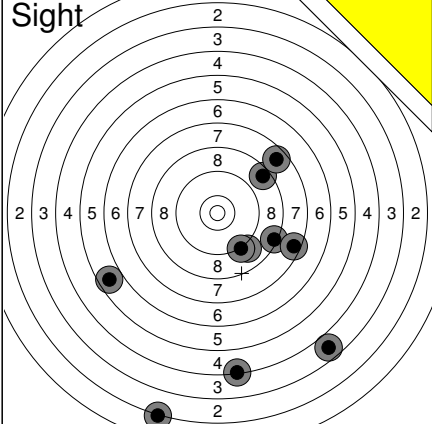
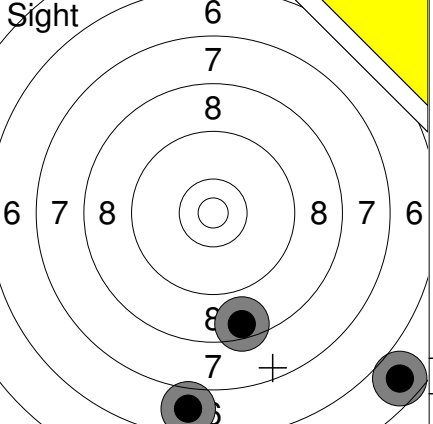
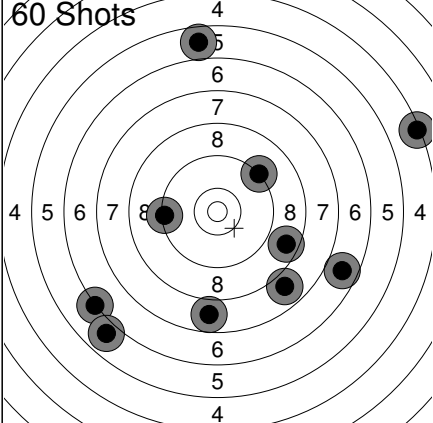
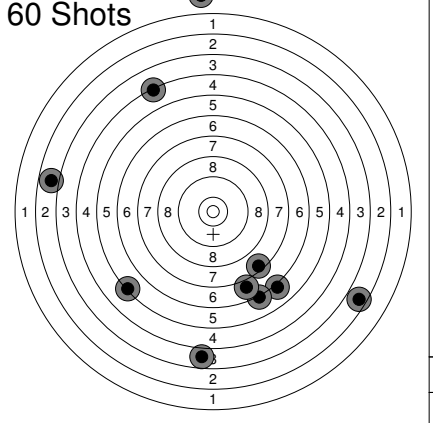
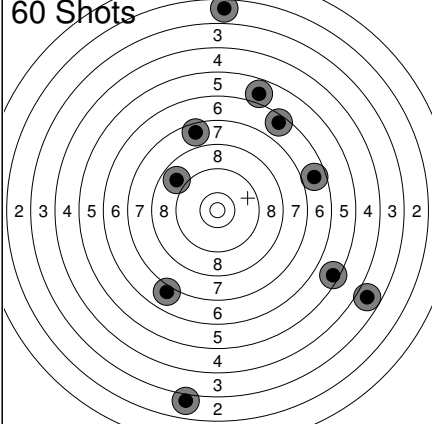
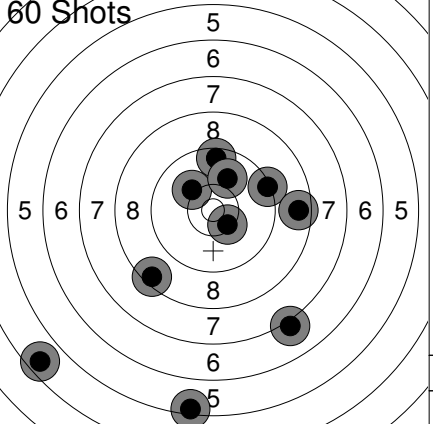
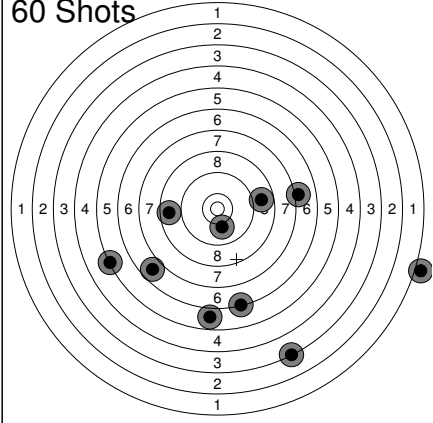
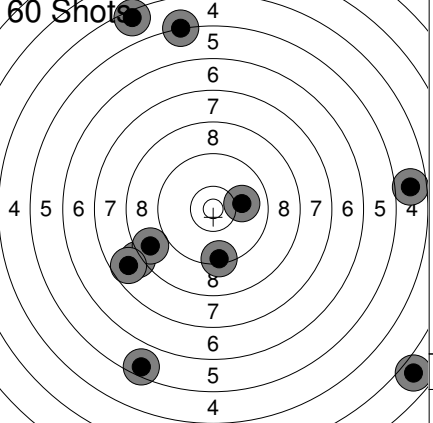
<p><b>Sight</b></p> 	<p><b>Sight</b></p> 	<table style="width:100%; border-collapse: collapse;"> <tr> <td style="width:50%;">11: 5.7 ↘</td> <td style="width:50%;">12: 6.8 ↓</td> </tr> <tr> <td>13: 8.5 ↓</td> <td></td> </tr> </table>	11: 5.7 ↘	12: 6.8 ↓	13: 8.5 ↓							
11: 5.7 ↘	12: 6.8 ↓											
13: 8.5 ↓												
<p><b>60 Shots</b></p> 	<p><b>60 Shots</b></p> 	<table style="width:100%; border-collapse: collapse;"> <tr> <td style="width:50%;">11: 4.3 ↗</td> <td style="width:50%;">12: 2.9 ←</td> </tr> <tr> <td>13: 2.6 ↘</td> <td>14: 7.5 ↘</td> </tr> <tr> <td>15: 3.8 ↓</td> <td>16: 6.1 ↓</td> </tr> <tr> <td>17: 0.0 ↑</td> <td>18: 5.3 ↖</td> </tr> <tr> <td>19: 6.2 ↓</td> <td>20: 6.9 ↓</td> </tr> </table>	11: 4.3 ↗	12: 2.9 ←	13: 2.6 ↘	14: 7.5 ↘	15: 3.8 ↓	16: 6.1 ↓	17: 0.0 ↑	18: 5.3 ↖	19: 6.2 ↓	20: 6.9 ↓
11: 4.3 ↗	12: 2.9 ←											
13: 2.6 ↘	14: 7.5 ↘											
15: 3.8 ↓	16: 6.1 ↓											
17: 0.0 ↑	18: 5.3 ↖											
19: 6.2 ↓	20: 6.9 ↓											
<p><b>60 Shots</b></p> 	<p><b>60 Shots</b></p> 	<table style="width:100%; border-collapse: collapse;"> <tr> <td style="width:50%;">31: 5.4 ↓</td> <td style="width:50%;">32: 10.1 ↖</td> </tr> <tr> <td>33: 9.3 →</td> <td>34: 9.5 ↑</td> </tr> <tr> <td>35: 10.0 ↑</td> <td>36: 7.1 ↓</td> </tr> <tr> <td>37: 10.4x ↓</td> <td>38: 8.6 →</td> </tr> <tr> <td>39: 4.6 ↖</td> <td>40: 8.4 ↖</td> </tr> </table>	31: 5.4 ↓	32: 10.1 ↖	33: 9.3 →	34: 9.5 ↑	35: 10.0 ↑	36: 7.1 ↓	37: 10.4x ↓	38: 8.6 →	39: 4.6 ↖	40: 8.4 ↖
31: 5.4 ↓	32: 10.1 ↖											
33: 9.3 →	34: 9.5 ↑											
35: 10.0 ↑	36: 7.1 ↓											
37: 10.4x ↓	38: 8.6 →											
39: 4.6 ↖	40: 8.4 ↖											
<p><b>60 Shots</b></p> 	<p><b>60 Shots</b></p> 	<table style="width:100%; border-collapse: collapse;"> <tr> <td style="width:50%;">51: 8.1 ↖</td> <td style="width:50%;">52: 8.7 ↖</td> </tr> <tr> <td>53: 5.5 ↓</td> <td>54: 10.0 →</td> </tr> <tr> <td>55: 4.7 →</td> <td>56: 9.4 ↓</td> </tr> <tr> <td>57: 4.5 ↗</td> <td>58: 5.2 ↑</td> </tr> <tr> <td>59: 7.8 ↖</td> <td>60: 2.9 ↓</td> </tr> </table>	51: 8.1 ↖	52: 8.7 ↖	53: 5.5 ↓	54: 10.0 →	55: 4.7 →	56: 9.4 ↓	57: 4.5 ↗	58: 5.2 ↑	59: 7.8 ↖	60: 2.9 ↓
51: 8.1 ↖	52: 8.7 ↖											
53: 5.5 ↓	54: 10.0 →											
55: 4.7 →	56: 9.4 ↓											
57: 4.5 ↗	58: 5.2 ↑											
59: 7.8 ↖	60: 2.9 ↓											

Relay **2** Lane **29** **HUANG Margaret**

2023 SFC Pistol Nationals BC SJ WP

16.07.2023 23PN-AP-Q2 Alberta Handgun Association

Comment Signature

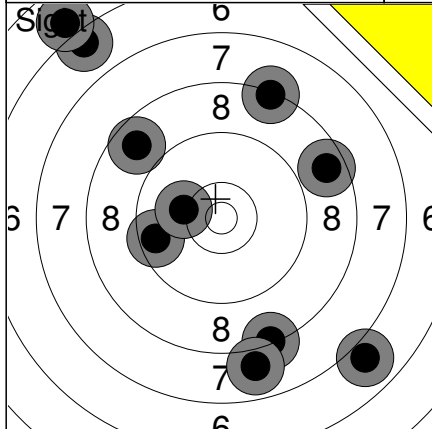

1:	8.3	↑
2:	8.6	→
3:	6.5	↗
4:	8.7	↗
5:	9.6	←
6:	5.9	↗
7:	8.3	↘
8:	6.9	↘
9:	7.9	↘
10:	10.2	←
Series	75 (0x)	
	0 (0x)	

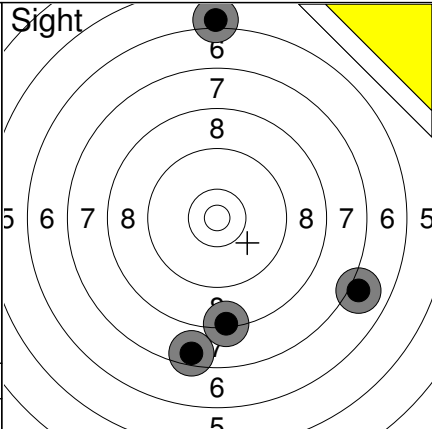

11:	7.0	→
12:	8.3	↓
13:	7.5	↓
14:	6.0	↑
Series	28 (0x)	
	0 (0x)	

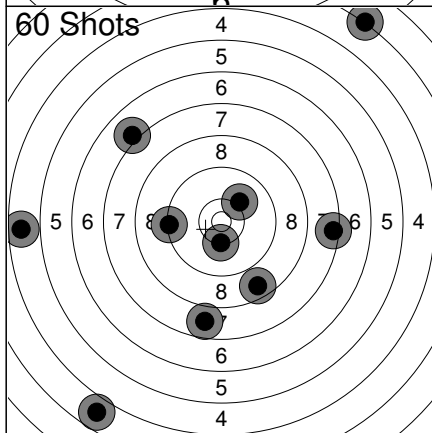

1:	3.8	↙
2:	3.2	↗
3:	7.0	↗
4:	9.3	←
5:	4.6	←
6:	10.3	↘
7:	7.8	↘
8:	8.6	↘
9:	10.1	↗
10:	7.4	→
Series	68 (0x)	
	68 (0x)	

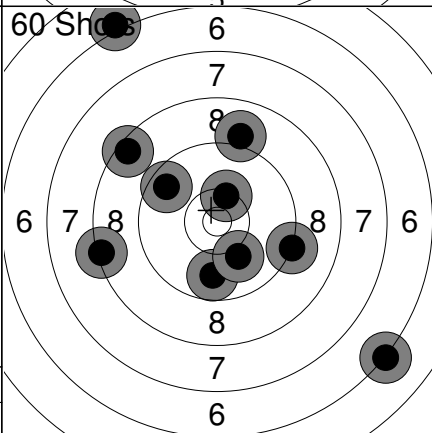

11:	9.0	↑
12:	6.2	↘
13:	6.1	↗
14:	9.2	→
15:	9.6	↗
16:	9.8	↓
17:	10.4	↑
18:	8.3	←
19:	10.1	↘
20:	8.5	↗
Series	84 (0x)	
	152 (0x)	

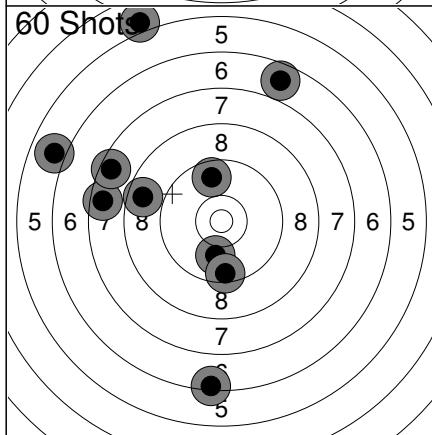

21:	9.7	↑
22:	8.7	←
23:	7.6	←
24:	6.7	↗
25:	6.3	↘
26:	10.0	↘
27:	7.5	↗
28:	4.9	↗
29:	5.9	←
30:	9.5	↓
Series	71 (0x)	
	223 (0x)	

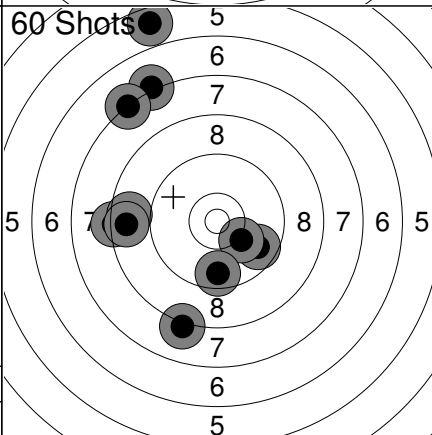

31:	7.1	↗
32:	8.3	←
33:	8.7	←
34:	9.7	↘
35:	8.1	↘
36:	8.6	←
37:	5.6	↗
38:	7.3	↗
39:	10.2	↘
40:	9.6	↓
Series	79 (0x)	
	302 (0x)	

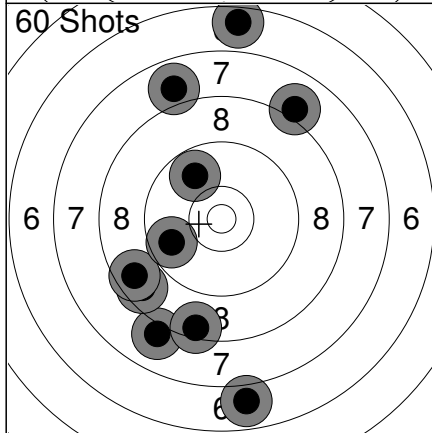

41:	6.6	↑
42:	8.0	↘
43:	8.5	↘
44:	8.6	←
45:	6.9	↘
46:	8.7	←
47:	9.7	←
48:	8.0	↗
49:	9.8	↗
50:	7.9	↑
Series	77 (0x)	
	379 (0x)	

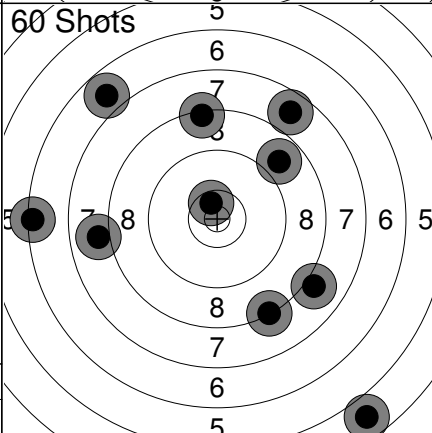

51:	6.8	↗
52:	8.3	↑
53:	7.9	←
54:	4.8	↘
55:	8.0	↘
56:	6.3	←
57:	10.5x	↗
58:	8.8	↗
59:	7.7	↗
60:	8.3	↓
Series	72 (1x)	
	451 (1x)	

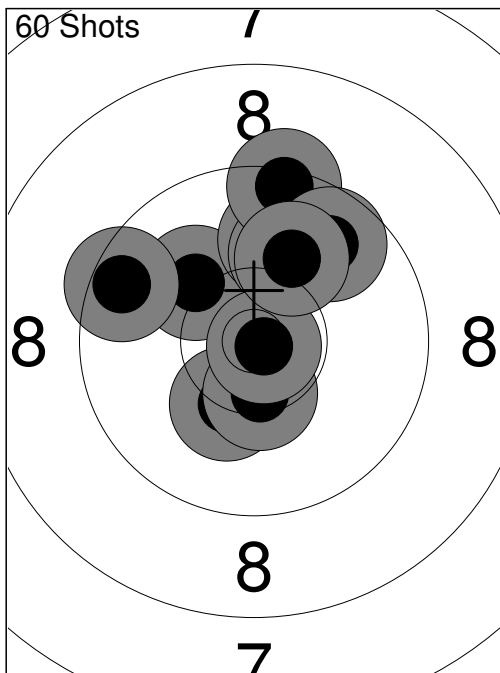

31:	10.3	↘
32:	10.4x	↓
33:	10.1	↖
34:	9.9	↑
35:	10.0	↗
36:	10.8x	→
37:	9.4	↑
38:	9.5	↖
39:	9.7	↗
40:	10.1	↗
Series	96 ( 2x)	
	373 ( 6x)	

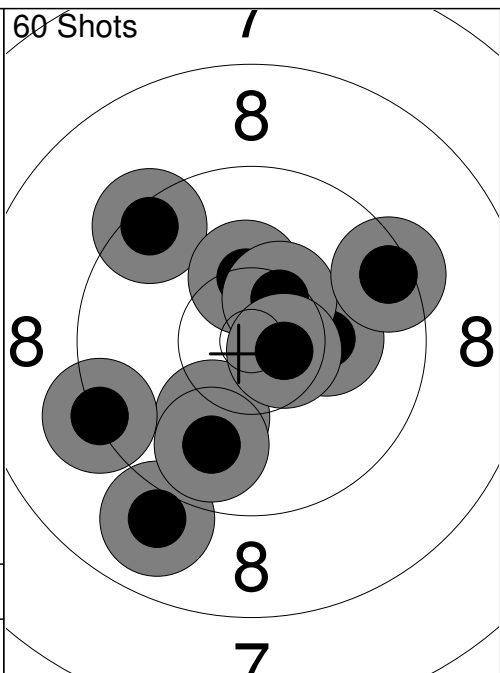

41:	10.1	↘
42:	9.3	↖
43:	9.0	↘
44:	9.4	↖
45:	10.2	→
46:	10.3	↑
47:	10.5x	↗
48:	9.5	↗
49:	9.9	↓
50:	10.6x	→
Series	95 ( 2x)	
	468 ( 8x)	

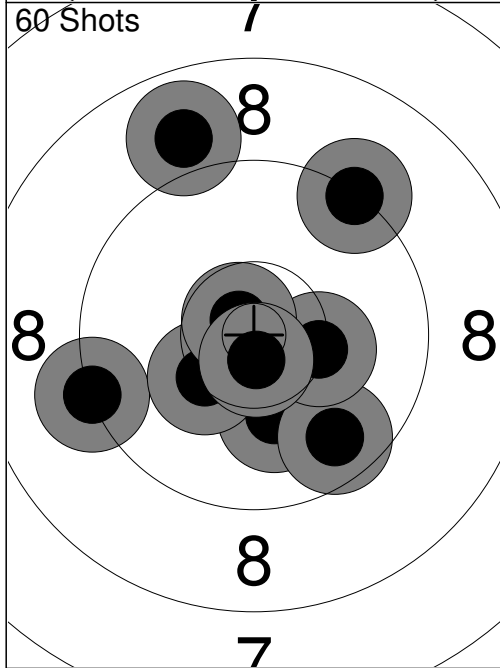

51:	9.3	↖
52:	10.4x	↓
53:	10.1	↓
54:	10.3	↖
55:	9.7	↓
56:	10.3	→
57:	10.7x	↖
58:	9.3	↗
59:	8.9	↑
60:	10.7x	↓
Series	95 ( 3x)	
	563 (11x)	

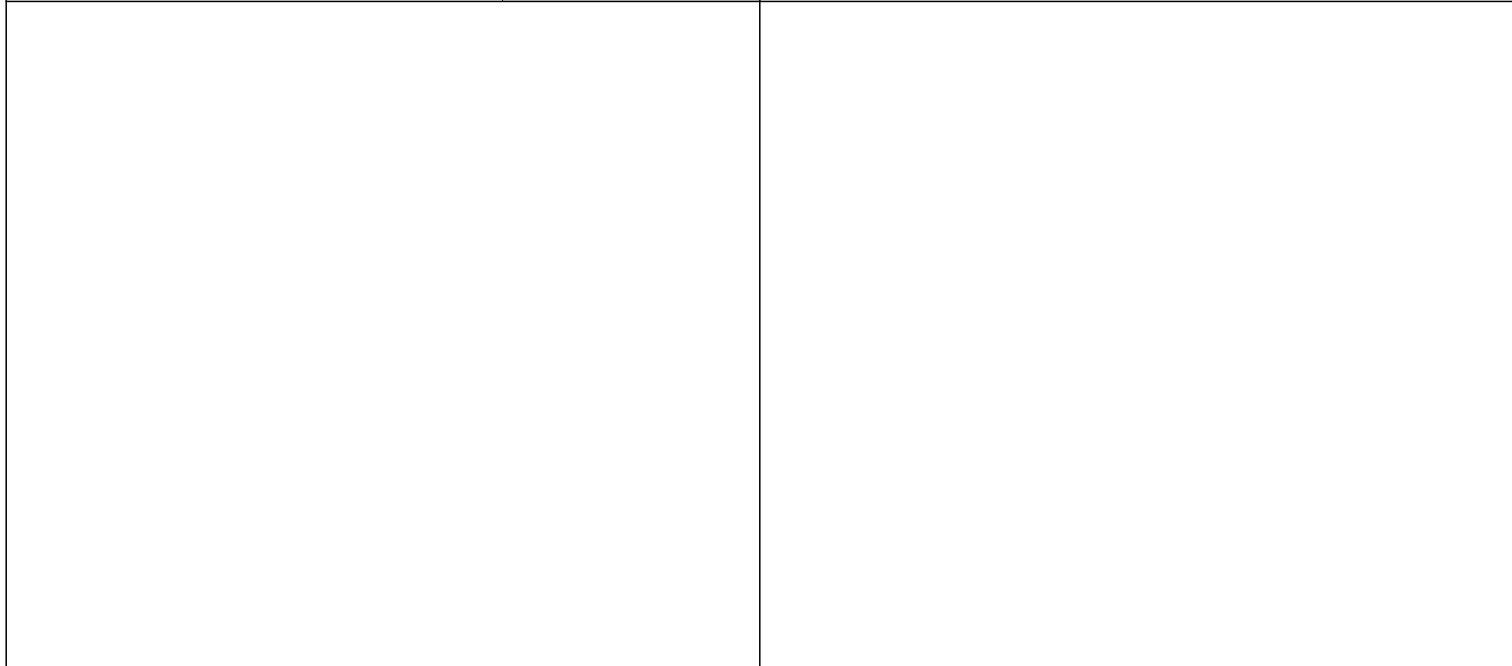

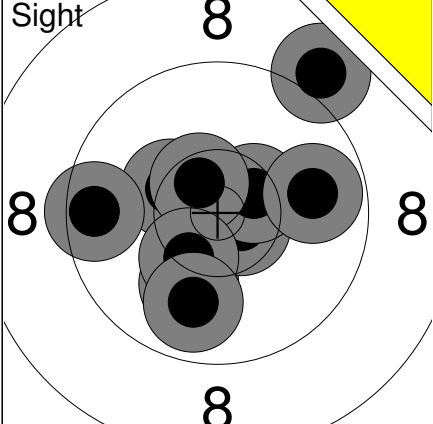
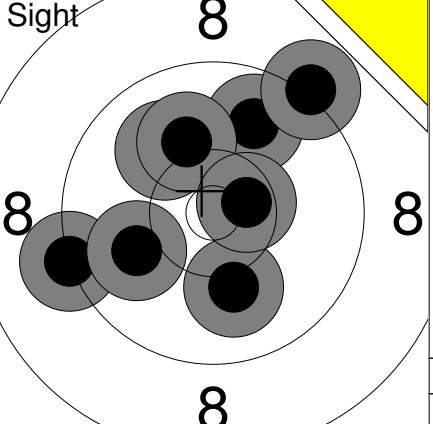
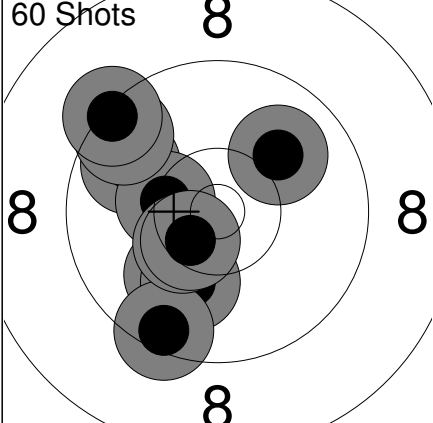
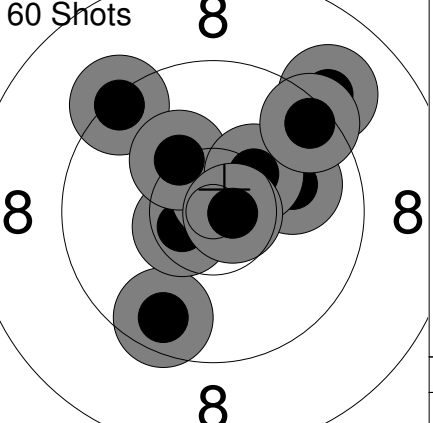
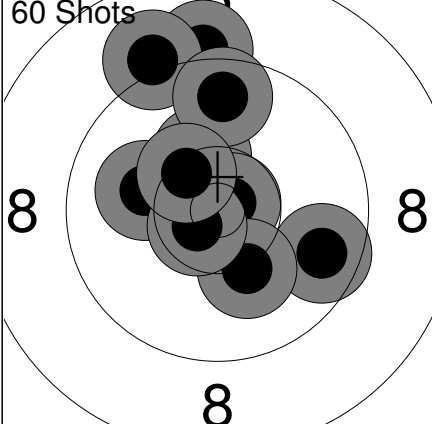
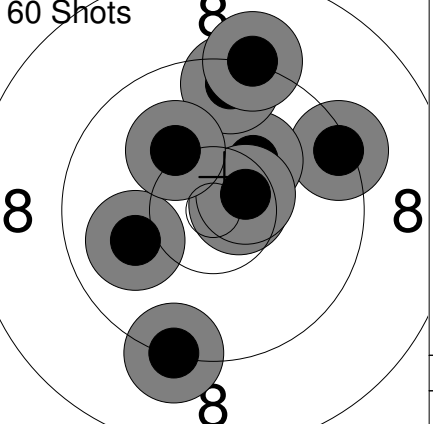
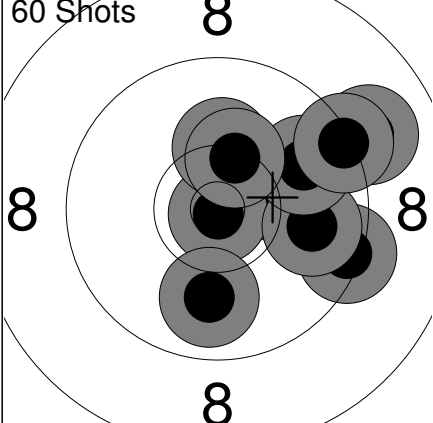
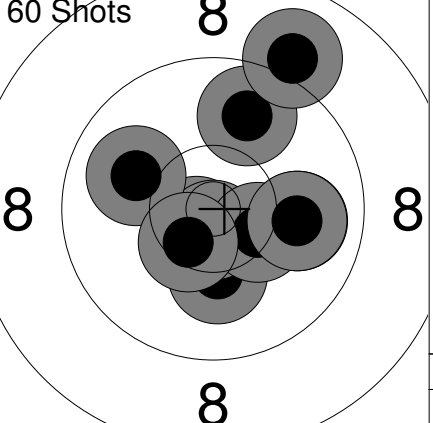
Sight	8	Sight	8																																																																								
	<table border="1" style="width:100%; border-collapse: collapse;"> <tr><td>1:</td><td>10.1</td><td>↓</td></tr> <tr><td>2:</td><td>10.6x</td><td>→</td></tr> <tr><td>3:</td><td>10.5x</td><td>→</td></tr> <tr><td>4:</td><td>10.4</td><td>←</td></tr> <tr><td>5:</td><td>10.5x</td><td>↗</td></tr> <tr><td>6:</td><td>10.3</td><td>↙</td></tr> <tr><td>7:</td><td>9.5</td><td>←</td></tr> <tr><td>8:</td><td>9.8</td><td>→</td></tr> <tr><td>9:</td><td>9.9</td><td>↓</td></tr> <tr><td>10:</td><td>9.0</td><td>↗</td></tr> <tr><td colspan="2">Series</td><td>96 ( 3x)</td></tr> <tr><td colspan="2"></td><td>0 ( 0x)</td></tr> </table>	1:	10.1	↓	2:	10.6x	→	3:	10.5x	→	4:	10.4	←	5:	10.5x	↗	6:	10.3	↙	7:	9.5	←	8:	9.8	→	9:	9.9	↓	10:	9.0	↗	Series		96 ( 3x)			0 ( 0x)		<table border="1" style="width:100%; border-collapse: collapse;"> <tr><td>11:</td><td>10.1</td><td>↓</td></tr> <tr><td>12:</td><td>9.2</td><td>←</td></tr> <tr><td>13:</td><td>10.1</td><td>↖</td></tr> <tr><td>14:</td><td>9.8</td><td>↑</td></tr> <tr><td>15:</td><td>10.1</td><td>↑</td></tr> <tr><td>16:</td><td>10.6x</td><td>→</td></tr> <tr><td>17:</td><td>9.2</td><td>↗</td></tr> <tr><td>18:</td><td>10.0</td><td>←</td></tr> <tr><td colspan="2">Series</td><td>77 ( 1x)</td></tr> <tr><td colspan="2"></td><td>0 ( 0x)</td></tr> </table>	11:	10.1	↓	12:	9.2	←	13:	10.1	↖	14:	9.8	↑	15:	10.1	↑	16:	10.6x	→	17:	9.2	↗	18:	10.0	←	Series		77 ( 1x)			0 ( 0x)						
1:	10.1	↓																																																																									
2:	10.6x	→																																																																									
3:	10.5x	→																																																																									
4:	10.4	←																																																																									
5:	10.5x	↗																																																																									
6:	10.3	↙																																																																									
7:	9.5	←																																																																									
8:	9.8	→																																																																									
9:	9.9	↓																																																																									
10:	9.0	↗																																																																									
Series		96 ( 3x)																																																																									
		0 ( 0x)																																																																									
11:	10.1	↓																																																																									
12:	9.2	←																																																																									
13:	10.1	↖																																																																									
14:	9.8	↑																																																																									
15:	10.1	↑																																																																									
16:	10.6x	→																																																																									
17:	9.2	↗																																																																									
18:	10.0	←																																																																									
Series		77 ( 1x)																																																																									
		0 ( 0x)																																																																									
60 Shots	8	60 Shots	8																																																																								
	<table border="1" style="width:100%; border-collapse: collapse;"> <tr><td>1:</td><td>10.1</td><td>↓</td></tr> <tr><td>2:</td><td>10.1</td><td>↓</td></tr> <tr><td>3:</td><td>9.8</td><td>↗</td></tr> <tr><td>4:</td><td>10.3</td><td>←</td></tr> <tr><td>5:</td><td>9.5</td><td>↓</td></tr> <tr><td>6:</td><td>9.6</td><td>↗</td></tr> <tr><td>7:</td><td>10.4x</td><td>↙</td></tr> <tr><td>8:</td><td>9.3</td><td>↗</td></tr> <tr><td>9:</td><td>10.5x</td><td>↙</td></tr> <tr><td>10:</td><td>10.0</td><td>↗</td></tr> <tr><td colspan="2">Series</td><td>96 ( 2x)</td></tr> <tr><td colspan="2"></td><td>96 ( 2x)</td></tr> </table>	1:	10.1	↓	2:	10.1	↓	3:	9.8	↗	4:	10.3	←	5:	9.5	↓	6:	9.6	↗	7:	10.4x	↙	8:	9.3	↗	9:	10.5x	↙	10:	10.0	↗	Series		96 ( 2x)			96 ( 2x)		<table border="1" style="width:100%; border-collapse: collapse;"> <tr><td>11:</td><td>9.6</td><td>↓</td></tr> <tr><td>12:</td><td>10.6x</td><td>←</td></tr> <tr><td>13:</td><td>9.3</td><td>↖</td></tr> <tr><td>14:</td><td>10.7x</td><td>↑</td></tr> <tr><td>15:</td><td>10.3</td><td>↖</td></tr> <tr><td>16:</td><td>10.0</td><td>→</td></tr> <tr><td>17:</td><td>10.3</td><td>↗</td></tr> <tr><td>18:</td><td>9.1</td><td>↗</td></tr> <tr><td>19:</td><td>9.5</td><td>↗</td></tr> <tr><td>20:</td><td>10.7x</td><td>→</td></tr> <tr><td colspan="2">Series</td><td>96 ( 3x)</td></tr> <tr><td colspan="2"></td><td>192 ( 5x)</td></tr> </table>	11:	9.6	↓	12:	10.6x	←	13:	9.3	↖	14:	10.7x	↑	15:	10.3	↖	16:	10.0	→	17:	10.3	↗	18:	9.1	↗	19:	9.5	↗	20:	10.7x	→	Series		96 ( 3x)			192 ( 5x)
1:	10.1	↓																																																																									
2:	10.1	↓																																																																									
3:	9.8	↗																																																																									
4:	10.3	←																																																																									
5:	9.5	↓																																																																									
6:	9.6	↗																																																																									
7:	10.4x	↙																																																																									
8:	9.3	↗																																																																									
9:	10.5x	↙																																																																									
10:	10.0	↗																																																																									
Series		96 ( 2x)																																																																									
		96 ( 2x)																																																																									
11:	9.6	↓																																																																									
12:	10.6x	←																																																																									
13:	9.3	↖																																																																									
14:	10.7x	↑																																																																									
15:	10.3	↖																																																																									
16:	10.0	→																																																																									
17:	10.3	↗																																																																									
18:	9.1	↗																																																																									
19:	9.5	↗																																																																									
20:	10.7x	→																																																																									
Series		96 ( 3x)																																																																									
		192 ( 5x)																																																																									
60 Shots	8	60 Shots	8																																																																								
	<table border="1" style="width:100%; border-collapse: collapse;"> <tr><td>21:</td><td>10.3</td><td>↑</td></tr> <tr><td>22:</td><td>10.8x</td><td>→</td></tr> <tr><td>23:</td><td>9.7</td><td>→</td></tr> <tr><td>24:</td><td>10.2</td><td>↓</td></tr> <tr><td>25:</td><td>9.1</td><td>↑</td></tr> <tr><td>26:</td><td>10.1</td><td>←</td></tr> <tr><td>27:</td><td>10.7x</td><td>↙</td></tr> <tr><td>28:</td><td>9.1</td><td>↗</td></tr> <tr><td>29:</td><td>9.7</td><td>↑</td></tr> <tr><td>30:</td><td>10.4x</td><td>↖</td></tr> <tr><td colspan="2">Series</td><td>96 ( 3x)</td></tr> <tr><td colspan="2"></td><td>288 ( 8x)</td></tr> </table>	21:	10.3	↑	22:	10.8x	→	23:	9.7	→	24:	10.2	↓	25:	9.1	↑	26:	10.1	←	27:	10.7x	↙	28:	9.1	↗	29:	9.7	↑	30:	10.4x	↖	Series		96 ( 3x)			288 ( 8x)		<table border="1" style="width:100%; border-collapse: collapse;"> <tr><td>31:</td><td>10.3</td><td>↑</td></tr> <tr><td>32:</td><td>9.4</td><td>→</td></tr> <tr><td>33:</td><td>10.6x</td><td>→</td></tr> <tr><td>34:</td><td>10.2</td><td>↗</td></tr> <tr><td>35:</td><td>10.0</td><td>←</td></tr> <tr><td>36:</td><td>9.3</td><td>↓</td></tr> <tr><td>37:</td><td>9.5</td><td>↑</td></tr> <tr><td>38:</td><td>10.5x</td><td>→</td></tr> <tr><td>39:</td><td>10.1</td><td>↖</td></tr> <tr><td>40:</td><td>9.2</td><td>↑</td></tr> <tr><td colspan="2">Series</td><td>96 ( 2x)</td></tr> <tr><td colspan="2"></td><td>384 ( 10x)</td></tr> </table>	31:	10.3	↑	32:	9.4	→	33:	10.6x	→	34:	10.2	↗	35:	10.0	←	36:	9.3	↓	37:	9.5	↑	38:	10.5x	→	39:	10.1	↖	40:	9.2	↑	Series		96 ( 2x)			384 ( 10x)
21:	10.3	↑																																																																									
22:	10.8x	→																																																																									
23:	9.7	→																																																																									
24:	10.2	↓																																																																									
25:	9.1	↑																																																																									
26:	10.1	←																																																																									
27:	10.7x	↙																																																																									
28:	9.1	↗																																																																									
29:	9.7	↑																																																																									
30:	10.4x	↖																																																																									
Series		96 ( 3x)																																																																									
		288 ( 8x)																																																																									
31:	10.3	↑																																																																									
32:	9.4	→																																																																									
33:	10.6x	→																																																																									
34:	10.2	↗																																																																									
35:	10.0	←																																																																									
36:	9.3	↓																																																																									
37:	9.5	↑																																																																									
38:	10.5x	→																																																																									
39:	10.1	↖																																																																									
40:	9.2	↑																																																																									
Series		96 ( 2x)																																																																									
		384 ( 10x)																																																																									
60 Shots	8	60 Shots	8																																																																								
	<table border="1" style="width:100%; border-collapse: collapse;"> <tr><td>41:</td><td>9.4</td><td>→</td></tr> <tr><td>42:</td><td>10.4x</td><td>→</td></tr> <tr><td>43:</td><td>10.9x</td><td>↓</td></tr> <tr><td>44:</td><td>10.3</td><td>↑</td></tr> <tr><td>45:</td><td>9.9</td><td>→</td></tr> <tr><td>46:</td><td>9.0</td><td>→</td></tr> <tr><td>47:</td><td>9.9</td><td>→</td></tr> <tr><td>48:</td><td>10.3</td><td>↑</td></tr> <tr><td>49:</td><td>9.3</td><td>→</td></tr> <tr><td>50:</td><td>9.9</td><td>↓</td></tr> <tr><td colspan="2">Series</td><td>94 ( 2x)</td></tr> <tr><td colspan="2"></td><td>478 ( 12x)</td></tr> </table>	41:	9.4	→	42:	10.4x	→	43:	10.9x	↓	44:	10.3	↑	45:	9.9	→	46:	9.0	→	47:	9.9	→	48:	10.3	↑	49:	9.3	→	50:	9.9	↓	Series		94 ( 2x)			478 ( 12x)		<table border="1" style="width:100%; border-collapse: collapse;"> <tr><td>51:</td><td>9.8</td><td>↑</td></tr> <tr><td>52:</td><td>10.2</td><td>↓</td></tr> <tr><td>53:</td><td>10.0</td><td>→</td></tr> <tr><td>54:</td><td>10.7x</td><td>↙</td></tr> <tr><td>55:</td><td>10.7x</td><td>↓</td></tr> <tr><td>56:</td><td>10.4x</td><td>→</td></tr> <tr><td>57:</td><td>9.0</td><td>↗</td></tr> <tr><td>58:</td><td>10.0</td><td>←</td></tr> <tr><td>59:</td><td>10.0</td><td>→</td></tr> <tr><td>60:</td><td>10.5x</td><td>↙</td></tr> <tr><td colspan="2">Series</td><td>98 ( 4x)</td></tr> <tr><td colspan="2"></td><td>576 ( 16x)</td></tr> </table>	51:	9.8	↑	52:	10.2	↓	53:	10.0	→	54:	10.7x	↙	55:	10.7x	↓	56:	10.4x	→	57:	9.0	↗	58:	10.0	←	59:	10.0	→	60:	10.5x	↙	Series		98 ( 4x)			576 ( 16x)
41:	9.4	→																																																																									
42:	10.4x	→																																																																									
43:	10.9x	↓																																																																									
44:	10.3	↑																																																																									
45:	9.9	→																																																																									
46:	9.0	→																																																																									
47:	9.9	→																																																																									
48:	10.3	↑																																																																									
49:	9.3	→																																																																									
50:	9.9	↓																																																																									
Series		94 ( 2x)																																																																									
		478 ( 12x)																																																																									
51:	9.8	↑																																																																									
52:	10.2	↓																																																																									
53:	10.0	→																																																																									
54:	10.7x	↙																																																																									
55:	10.7x	↓																																																																									
56:	10.4x	→																																																																									
57:	9.0	↗																																																																									
58:	10.0	←																																																																									
59:	10.0	→																																																																									
60:	10.5x	↙																																																																									
Series		98 ( 4x)																																																																									
		576 ( 16x)																																																																									



<b>Relay</b> 1	<b>Lane</b> 3	<h1>AASA Toomas</h1>
-------------------	------------------	----------------------

2023 SFC Pistol Nationals	ON	MA	MP
---------------------------	----	----	----

16.07.2023	23PN-AP-Q2	Alberta Handgun Association
------------	------------	-----------------------------

Comment	Signature
---------	-----------

<p>Sight</p>	<p>1: 10.5x ← 2: 9.2 ↙ 3: 8.9 ← 4: 10.6x ↓ 5: 8.9 ↓ 6: 7.6 ← 7: 7.5 ↓ 8: 9.1 → 9: 7.9 ↗ 10: 9.3 →</p> <p>Series 84 (2x) 0 (0x)</p>	<p>Sight</p>	<p>11: 8.7 ↗ 12: 8.9 ← 13: 9.5 → 14: 10.2 ↗ 15: 6.4 ← 16: 10.1 ↑ 17: 8.2 ← 18: 10.7x ↖</p> <p>Series 69 (1x) 0 (0x)</p>
<p>60 Shots</p>	<p>1: 7.8 ← 2: 10.4 ↗ 3: 10.2 ↓ 4: 9.1 ↓ 5: 8.7 ↗ 6: 10.3 ↓ 7: 9.7 ← 8: 9.2 ← 9: 9.0 ← 10: 9.9 ↗</p> <p>Series 90 (0x) 90 (0x)</p>	<p>60 Shots</p>	<p>11: 9.9 ↓ 12: 8.9 ↑ 13: 10.1 ↘ 14: 8.8 ↗ 15: 10.8x → 16: 10.1 ↗ 17: 8.3 ← 18: 8.2 ↑ 19: 8.7 ↙ 20: 9.0 ↓</p> <p>Series 88 (1x) 178 (1x)</p>
<p>60 Shots</p>	<p>21: 9.5 ↓ 22: 9.0 ← 23: 9.0 ← 24: 9.5 ↗ 25: 10.2 → 26: 9.0 ↗ 27: 8.7 ← 28: 9.2 → 29: 7.7 ↓ 30: 9.3 ←</p> <p>Series 88 (0x) 266 (1x)</p>	<p>60 Shots</p>	<p>31: 10.1 ← 32: 10.0 ↖ 33: 9.1 ↓ 34: 8.2 ← 35: 10.2 ↑ 36: 9.4 ← 37: 9.2 → 38: 10.5x ↓ 39: 9.3 ↓ 40: 10.1 ←</p> <p>Series 94 (1x) 360 (2x)</p>
<p>60 Shots</p>	<p>41: 10.4x ← 42: 9.8 ← 43: 7.9 → 44: 10.4x ↓ 45: 10.3 ↗ 46: 10.1 ← 47: 7.7 ↑ 48: 9.8 ↑ 49: 9.8 → 50: 10.1 ↗</p> <p>Series 91 (2x) 451 (4x)</p>	<p>60 Shots</p>	<p>51: 9.0 ↗ 52: 8.3 → 53: 9.2 ↗ 54: 9.0 ↗ 55: 8.1 → 56: 10.8x ↓ 57: 10.5x ↑ 58: 10.3 ↗ 59: 9.7 ↙ 60: 8.5 →</p> <p>Series 90 (2x) 541 (6x)</p>

Relay <b>1</b>	Lane <b>4</b>	<h1>GUIMONT Alain</h1>
-------------------	------------------	------------------------

2023 SFC Pistol Nationals	QC	MA	MP
---------------------------	----	----	----

16.07.2023	23PN-AP-Q2	Alberta Handgun Association
------------	------------	-----------------------------

Comment	Signature
---------	-----------

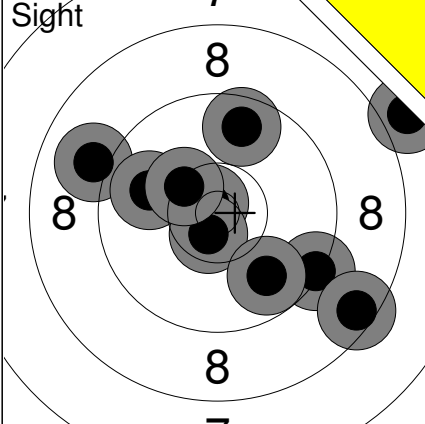
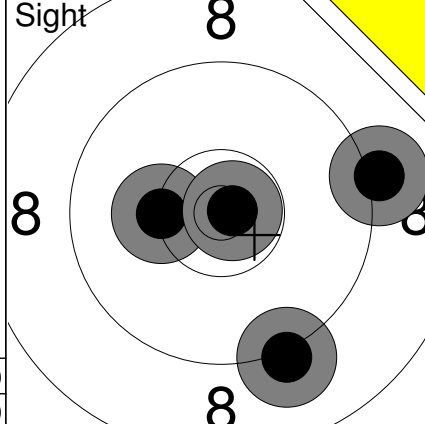
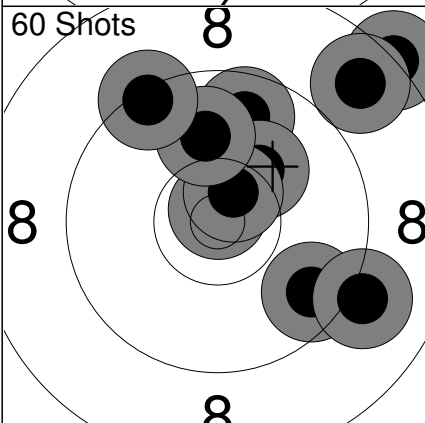
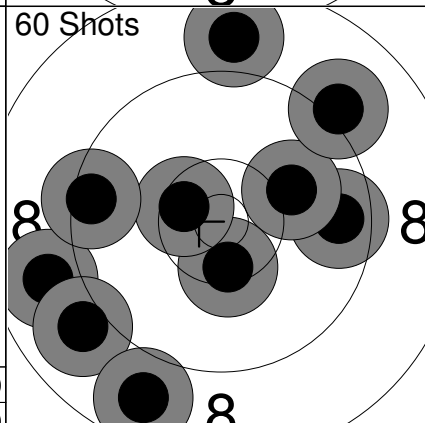
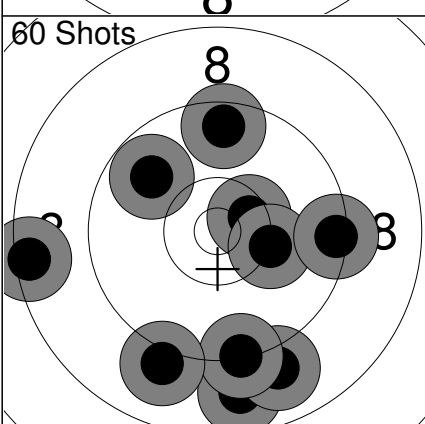
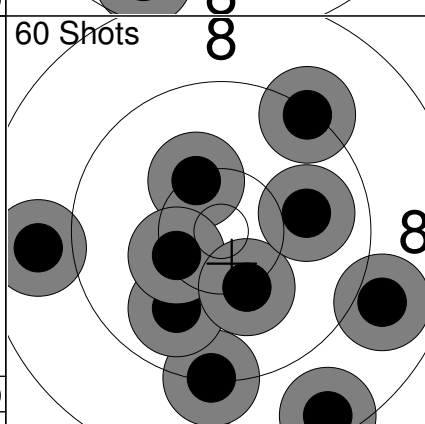
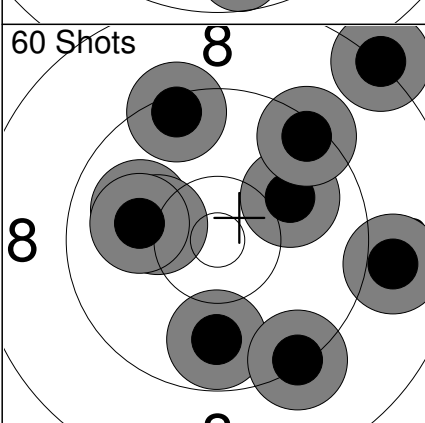
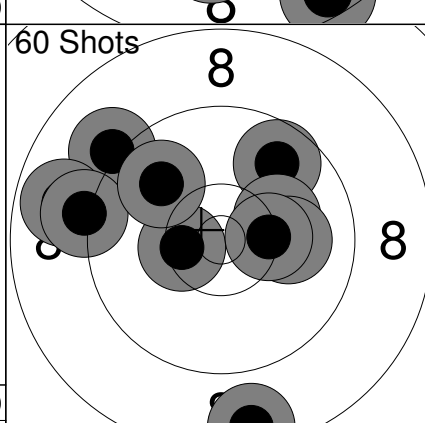
<p>Sight</p> 	<table border="1" style="width:100%; border-collapse: collapse;"> <tr><td>1:</td><td>9.3</td><td>↘</td></tr> <tr><td>2:</td><td>7.9</td><td>↗</td></tr> <tr><td>3:</td><td>9.7</td><td>↗</td></tr> <tr><td>4:</td><td>8.5</td><td>↘</td></tr> <tr><td>5:</td><td>10.8x</td><td>↗</td></tr> <tr><td>6:</td><td>9.0</td><td>↗</td></tr> <tr><td>7:</td><td>10.6x</td><td>↘</td></tr> <tr><td>8:</td><td>9.9</td><td>↗</td></tr> <tr><td>9:</td><td>10.3</td><td>↗</td></tr> <tr><td>10:</td><td>9.8</td><td>↘</td></tr> <tr><td colspan="2">Series</td><td>90 (2x)</td></tr> <tr><td colspan="2"></td><td>0 (0x)</td></tr> </table>	1:	9.3	↘	2:	7.9	↗	3:	9.7	↗	4:	8.5	↘	5:	10.8x	↗	6:	9.0	↗	7:	10.6x	↘	8:	9.9	↗	9:	10.3	↗	10:	9.8	↘	Series		90 (2x)			0 (0x)	<p>Sight</p> 	<table border="1" style="width:100%; border-collapse: collapse;"> <tr><td>11:</td><td>10.3</td><td>←</td></tr> <tr><td>12:</td><td>9.1</td><td>↓</td></tr> <tr><td>13:</td><td>10.8x</td><td>→</td></tr> <tr><td>14:</td><td>9.1</td><td>→</td></tr> <tr><td colspan="2">Series</td><td>38 (1x)</td></tr> <tr><td colspan="2"></td><td>0 (0x)</td></tr> </table>	11:	10.3	←	12:	9.1	↓	13:	10.8x	→	14:	9.1	→	Series		38 (1x)			0 (0x)																		
1:	9.3	↘																																																																									
2:	7.9	↗																																																																									
3:	9.7	↗																																																																									
4:	8.5	↘																																																																									
5:	10.8x	↗																																																																									
6:	9.0	↗																																																																									
7:	10.6x	↘																																																																									
8:	9.9	↗																																																																									
9:	10.3	↗																																																																									
10:	9.8	↘																																																																									
Series		90 (2x)																																																																									
		0 (0x)																																																																									
11:	10.3	←																																																																									
12:	9.1	↓																																																																									
13:	10.8x	→																																																																									
14:	9.1	→																																																																									
Series		38 (1x)																																																																									
		0 (0x)																																																																									
<p>60 Shots</p> 	<table border="1" style="width:100%; border-collapse: collapse;"> <tr><td>1:</td><td>9.7</td><td>↑</td></tr> <tr><td>2:</td><td>10.8x</td><td>↑</td></tr> <tr><td>3:</td><td>9.6</td><td>↘</td></tr> <tr><td>4:</td><td>9.1</td><td>→</td></tr> <tr><td>5:</td><td>10.2</td><td>↗</td></tr> <tr><td>6:</td><td>10.6x</td><td>↗</td></tr> <tr><td>7:</td><td>10.0</td><td>↑</td></tr> <tr><td>8:</td><td>9.4</td><td>↗</td></tr> <tr><td>9:</td><td>8.2</td><td>↗</td></tr> <tr><td>10:</td><td>8.7</td><td>↗</td></tr> <tr><td colspan="2">Series</td><td>92 (2x)</td></tr> <tr><td colspan="2"></td><td>92 (2x)</td></tr> </table>	1:	9.7	↑	2:	10.8x	↑	3:	9.6	↘	4:	9.1	→	5:	10.2	↗	6:	10.6x	↗	7:	10.0	↑	8:	9.4	↗	9:	8.2	↗	10:	8.7	↗	Series		92 (2x)			92 (2x)	<p>60 Shots</p> 	<table border="1" style="width:100%; border-collapse: collapse;"> <tr><td>11:</td><td>9.6</td><td>→</td></tr> <tr><td>12:</td><td>10.1</td><td>↗</td></tr> <tr><td>13:</td><td>8.9</td><td>←</td></tr> <tr><td>14:</td><td>10.4x</td><td>↓</td></tr> <tr><td>15:</td><td>10.5x</td><td>←</td></tr> <tr><td>16:</td><td>9.0</td><td>↙</td></tr> <tr><td>17:</td><td>8.7</td><td>↓</td></tr> <tr><td>18:</td><td>9.4</td><td>←</td></tr> <tr><td>19:</td><td>9.1</td><td>↗</td></tr> <tr><td>20:</td><td>8.8</td><td>↑</td></tr> <tr><td colspan="2">Series</td><td>90 (2x)</td></tr> <tr><td colspan="2"></td><td>182 (4x)</td></tr> </table>	11:	9.6	→	12:	10.1	↗	13:	8.9	←	14:	10.4x	↓	15:	10.5x	←	16:	9.0	↙	17:	8.7	↓	18:	9.4	←	19:	9.1	↗	20:	8.8	↑	Series		90 (2x)			182 (4x)
1:	9.7	↑																																																																									
2:	10.8x	↑																																																																									
3:	9.6	↘																																																																									
4:	9.1	→																																																																									
5:	10.2	↗																																																																									
6:	10.6x	↗																																																																									
7:	10.0	↑																																																																									
8:	9.4	↗																																																																									
9:	8.2	↗																																																																									
10:	8.7	↗																																																																									
Series		92 (2x)																																																																									
		92 (2x)																																																																									
11:	9.6	→																																																																									
12:	10.1	↗																																																																									
13:	8.9	←																																																																									
14:	10.4x	↓																																																																									
15:	10.5x	←																																																																									
16:	9.0	↙																																																																									
17:	8.7	↓																																																																									
18:	9.4	←																																																																									
19:	9.1	↗																																																																									
20:	8.8	↑																																																																									
Series		90 (2x)																																																																									
		182 (4x)																																																																									
<p>60 Shots</p> 	<table border="1" style="width:100%; border-collapse: collapse;"> <tr><td>21:</td><td>9.8</td><td>↖</td></tr> <tr><td>22:</td><td>10.5x</td><td>→</td></tr> <tr><td>23:</td><td>9.5</td><td>↑</td></tr> <tr><td>24:</td><td>8.8</td><td>↓</td></tr> <tr><td>25:</td><td>9.0</td><td>↘</td></tr> <tr><td>26:</td><td>8.4</td><td>←</td></tr> <tr><td>27:</td><td>9.3</td><td>↓</td></tr> <tr><td>28:</td><td>10.2</td><td>→</td></tr> <tr><td>29:</td><td>9.0</td><td>↓</td></tr> <tr><td>30:</td><td>9.4</td><td>→</td></tr> <tr><td colspan="2">Series</td><td>90 (1x)</td></tr> <tr><td colspan="2"></td><td>272 (5x)</td></tr> </table>	21:	9.8	↖	22:	10.5x	→	23:	9.5	↑	24:	8.8	↓	25:	9.0	↘	26:	8.4	←	27:	9.3	↓	28:	10.2	→	29:	9.0	↓	30:	9.4	→	Series		90 (1x)			272 (5x)	<p>60 Shots</p> 	<table border="1" style="width:100%; border-collapse: collapse;"> <tr><td>31:</td><td>9.3</td><td>↓</td></tr> <tr><td>32:</td><td>8.8</td><td>←</td></tr> <tr><td>33:</td><td>9.9</td><td>↓</td></tr> <tr><td>34:</td><td>10.3</td><td>↗</td></tr> <tr><td>35:</td><td>8.9</td><td>→</td></tr> <tr><td>36:</td><td>8.5</td><td>↓</td></tr> <tr><td>37:</td><td>10.4x</td><td>←</td></tr> <tr><td>38:</td><td>10.2</td><td>↓</td></tr> <tr><td>39:</td><td>9.3</td><td>↗</td></tr> <tr><td>40:</td><td>10.0</td><td>→</td></tr> <tr><td colspan="2">Series</td><td>91 (1x)</td></tr> <tr><td colspan="2"></td><td>363 (6x)</td></tr> </table>	31:	9.3	↓	32:	8.8	←	33:	9.9	↓	34:	10.3	↗	35:	8.9	→	36:	8.5	↓	37:	10.4x	←	38:	10.2	↓	39:	9.3	↗	40:	10.0	→	Series		91 (1x)			363 (6x)
21:	9.8	↖																																																																									
22:	10.5x	→																																																																									
23:	9.5	↑																																																																									
24:	8.8	↓																																																																									
25:	9.0	↘																																																																									
26:	8.4	←																																																																									
27:	9.3	↓																																																																									
28:	10.2	→																																																																									
29:	9.0	↓																																																																									
30:	9.4	→																																																																									
Series		90 (1x)																																																																									
		272 (5x)																																																																									
31:	9.3	↓																																																																									
32:	8.8	←																																																																									
33:	9.9	↓																																																																									
34:	10.3	↗																																																																									
35:	8.9	→																																																																									
36:	8.5	↓																																																																									
37:	10.4x	←																																																																									
38:	10.2	↓																																																																									
39:	9.3	↗																																																																									
40:	10.0	→																																																																									
Series		91 (1x)																																																																									
		363 (6x)																																																																									
<p>60 Shots</p> 	<table border="1" style="width:100%; border-collapse: collapse;"> <tr><td>41:</td><td>10.0</td><td>←</td></tr> <tr><td>42:</td><td>8.9</td><td>→</td></tr> <tr><td>43:</td><td>9.8</td><td>↓</td></tr> <tr><td>44:</td><td>9.4</td><td>↗</td></tr> <tr><td>45:</td><td>10.0</td><td>→</td></tr> <tr><td>46:</td><td>10.3</td><td>←</td></tr> <tr><td>47:</td><td>10.0</td><td>←</td></tr> <tr><td>48:</td><td>8.2</td><td>↗</td></tr> <tr><td>49:</td><td>9.3</td><td>↓</td></tr> <tr><td>50:</td><td>9.4</td><td>↗</td></tr> <tr><td colspan="2">Series</td><td>92 (0x)</td></tr> <tr><td colspan="2"></td><td>455 (6x)</td></tr> </table>	41:	10.0	←	42:	8.9	→	43:	9.8	↓	44:	9.4	↗	45:	10.0	→	46:	10.3	←	47:	10.0	←	48:	8.2	↗	49:	9.3	↓	50:	9.4	↗	Series		92 (0x)			455 (6x)	<p>60 Shots</p> 	<table border="1" style="width:100%; border-collapse: collapse;"> <tr><td>51:</td><td>9.1</td><td>↖</td></tr> <tr><td>52:</td><td>8.5</td><td>↓</td></tr> <tr><td>53:</td><td>9.7</td><td>↗</td></tr> <tr><td>54:</td><td>10.2</td><td>→</td></tr> <tr><td>55:</td><td>10.1</td><td>→</td></tr> <tr><td>56:</td><td>10.4x</td><td>←</td></tr> <tr><td>57:</td><td>8.9</td><td>←</td></tr> <tr><td>58:</td><td>9.2</td><td>←</td></tr> <tr><td>59:</td><td>9.9</td><td>↗</td></tr> <tr><td>60:</td><td>10.3</td><td>→</td></tr> <tr><td colspan="2">Series</td><td>92 (1x)</td></tr> <tr><td colspan="2"></td><td>547 (7x)</td></tr> </table>	51:	9.1	↖	52:	8.5	↓	53:	9.7	↗	54:	10.2	→	55:	10.1	→	56:	10.4x	←	57:	8.9	←	58:	9.2	←	59:	9.9	↗	60:	10.3	→	Series		92 (1x)			547 (7x)
41:	10.0	←																																																																									
42:	8.9	→																																																																									
43:	9.8	↓																																																																									
44:	9.4	↗																																																																									
45:	10.0	→																																																																									
46:	10.3	←																																																																									
47:	10.0	←																																																																									
48:	8.2	↗																																																																									
49:	9.3	↓																																																																									
50:	9.4	↗																																																																									
Series		92 (0x)																																																																									
		455 (6x)																																																																									
51:	9.1	↖																																																																									
52:	8.5	↓																																																																									
53:	9.7	↗																																																																									
54:	10.2	→																																																																									
55:	10.1	→																																																																									
56:	10.4x	←																																																																									
57:	8.9	←																																																																									
58:	9.2	←																																																																									
59:	9.9	↗																																																																									
60:	10.3	→																																																																									
Series		92 (1x)																																																																									
		547 (7x)																																																																									

Relay **1** Lane **5** **WICK Werner**

2023 SFC Pistol Nationals AB MA MP

16.07.2023 23PN-AP-Q2 Alberta Handgun Association

Comment Signature

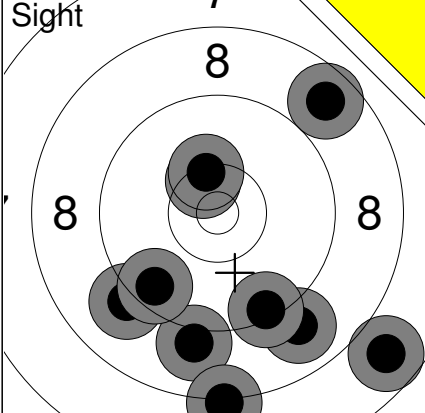
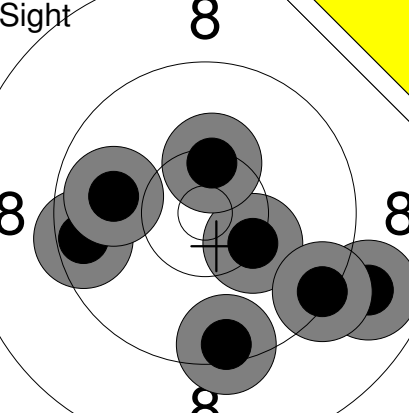
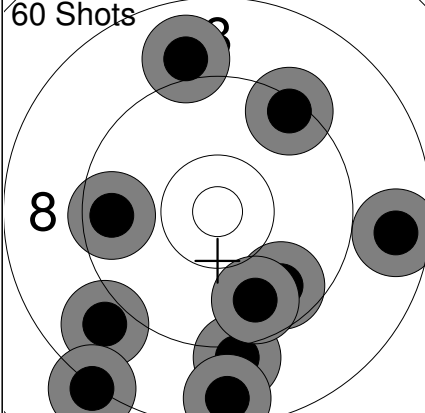
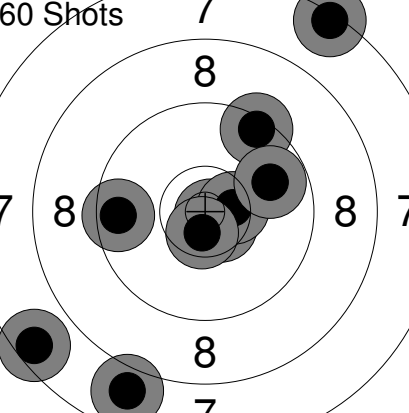
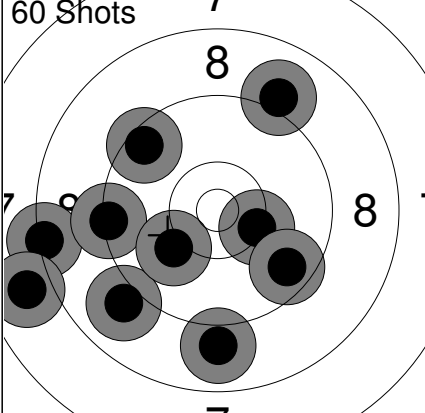
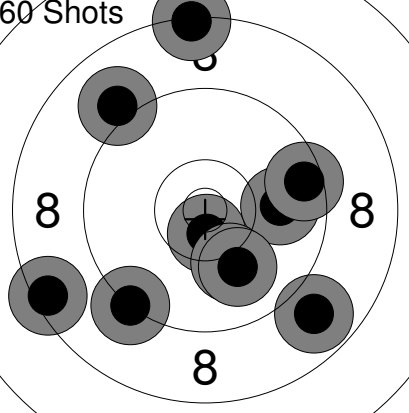
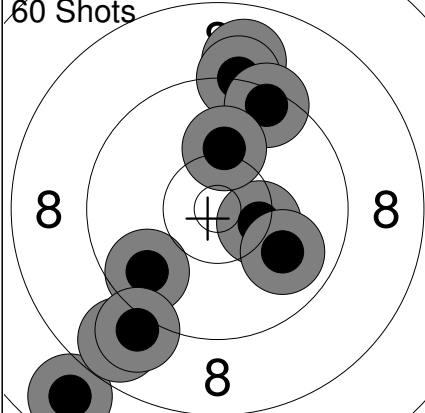
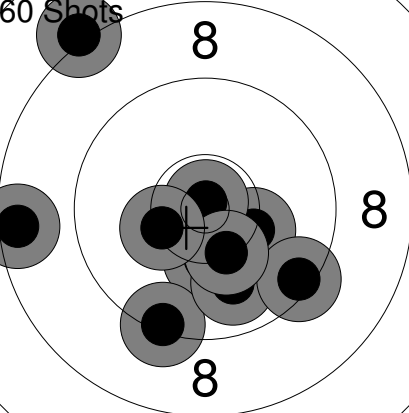
<p>Sight</p> 	<p>1: 10.4x ↗ 2: 10.3 ↗ 3: 8.9 ↘ 4: 9.4 ↘ 5: 8.7 ↗ 6: 9.1 ↖ 7: 9.0 ↘ 8: 8.2 ↘ 9: 7.8 ↘ 10: 9.5 ↘</p> <p>Series 87 (1x) 0 (0x)</p>	<p>Sight</p> 	<p>11: 8.9 → 12: 10.3 ↘ 13: 9.4 ↘ 14: 10.4x ↑ 15: 9.3 ↘ 16: 9.5 ← 17: 9.9 ←</p> <p>Series 64 (1x) 0 (0x)</p>
<p>60 Shots</p> 	<p>1: 9.4 ↗ 2: 8.9 ↖ 3: 9.0 ↗ 4: 8.7 → 5: 9.6 ← 6: 9.7 ↘ 7: 9.1 ↘ 8: 9.7 ↘ 9: 8.6 ↘ 10: 8.2 ↘</p> <p>Series 86 (0x) 86 (0x)</p>	<p>60 Shots</p> 	<p>11: 10.9x ↘ 12: 10.6x ↘ 13: 10.5x → 14: 7.5 ← 15: 9.6 ← 16: 7.9 ↘ 17: 7.3 ↗ 18: 9.4 ↗ 19: 9.8 → 20: 10.6x ↓</p> <p>Series 88 (4x) 174 (4x)</p>
<p>60 Shots</p> 	<p>21: 10.3 → 22: 9.0 ↗ 23: 8.3 ← 24: 9.3 ← 25: 9.5 ↗ 26: 8.9 ↘ 27: 9.6 ↘ 28: 9.0 ↖ 29: 10.1 ↖ 30: 7.9 ←</p> <p>Series 88 (0x) 262 (4x)</p>	<p>60 Shots</p> 	<p>31: 8.8 ↘ 32: 9.0 ↗ 33: 8.3 ↑ 34: 10.6x ↘ 35: 9.9 → 36: 10.1 ↘ 37: 10.0 ↘ 38: 8.4 ← 39: 9.5 → 40: 9.2 ↘</p> <p>Series 90 (1x) 352 (5x)</p>
<p>60 Shots</p> 	<p>41: 10.4x → 42: 9.0 ↑ 43: 9.2 ↑ 44: 7.8 ↖ 45: 8.8 ↖ 46: 9.4 ↗ 47: 9.9 ↘ 48: 9.7 ↖ 49: 9.0 ↖ 50: 10.2 ↑</p> <p>Series 89 (1x) 441 (6x)</p>	<p>60 Shots</p> 	<p>51: 10.3 ↓ 52: 10.3 → 53: 10.9x ↑ 54: 9.3 ↘ 55: 9.9 ↘ 56: 9.4 ↘ 57: 8.5 ← 58: 8.1 ↗ 59: 10.3 ↘ 60: 10.3 ←</p> <p>Series 93 (1x) 534 (7x)</p>

Relay **1** Lane **7** **SHAWN Richard**

2023 SFC Pistol Nationals BC MA MP

16.07.2023 23PN-AP-Q2 Alberta Handgun Association

Comment Signature

<p>Sight</p>	<p>1: 6.6 ← 2: 9.5 ↑ 3: 9.4 → 4: 5.8 ↗ 5: 7.8 ← 6: 6.7 → 7: 5.3 ← 8: 9.2 ←</p> <p>Series 56 (0x) 0 (0x)</p>	<p>60 Shots</p>	<p>1: 8.2 ← 2: 8.4 ← 3: 9.3 ↗ 4: 8.8 ← 5: 4.5 ← 6: 10.1 ↓ 7: 7.4 ← 8: 7.6 ↓ 9: 8.3 ← 10: 6.9 ↓</p> <p>Series 75 (0x) 75 (0x)</p>
<p>60 Shots</p>	<p>11: 7.0 ← 12: 8.9 → 13: 8.4 ↗ 14: 9.4 ↓ 15: 7.4 → 16: 9.8 ← 17: 8.8 ↗ 18: 8.2 ↓ 19: 5.9 ← 20: 7.9 →</p> <p>Series 76 (0x) 151 (0x)</p>	<p>60 Shots</p>	<p>21: 8.9 → 22: 8.1 ↗ 23: 5.2 → 24: 8.4 ↓ 25: 8.4 ↓ 26: 8.5 → 27: 9.0 → 28: 8.3 ↓ 29: 8.1 ↓ 30: 9.6 ↓</p> <p>Series 79 (0x) 230 (0x)</p>
<p>60 Shots</p>	<p>31: 4.9 ← 32: 10.1 ↓ 33: 8.4 ↓ 34: 8.3 → 35: 10.6x ↓ 36: 6.8 ↓ 37: 9.5 ↑ 38: 3.9 ← 39: 4.9 ↓ 40: 7.8 ↑</p> <p>Series 69 (1x) 299 (1x)</p>	<p>60 Shots</p>	<p>41: 9.0 ↗ 42: 6.3 ← 43: 9.8 ↓ 44: 7.8 ↓ 45: 10.5x → 46: 7.9 ← 47: 6.3 ↓ 48: 7.8 ← 49: 9.1 ← 50: 6.8 ↗</p> <p>Series 76 (1x) 375 (2x)</p>
<p>60 Shots</p>	<p>51: 10.2 ↓ 52: 8.0 ↗ 53: 6.6 ← 54: 6.8 ← 55: 9.2 → 56: 9.6 ← 57: 8.8 ↗ 58: 7.5 ↓ 59: 7.8 → 60: 9.7 ↓</p> <p>Series 79 (0x) 454 (2x)</p>		

Relay <b>1</b>	Lane <b>8</b>	<b>HYNES Mark</b>			
-------------------	------------------	-------------------	--	--	--

2023 SFC Pistol Nationals		ON		MA	MP
---------------------------	--	----	--	----	----

16.07.2023		23PN-AP-Q2		Alberta Handgun Association	
------------	--	------------	--	-----------------------------	--

Comment		Signature			
---------	--	-----------	--	--	--

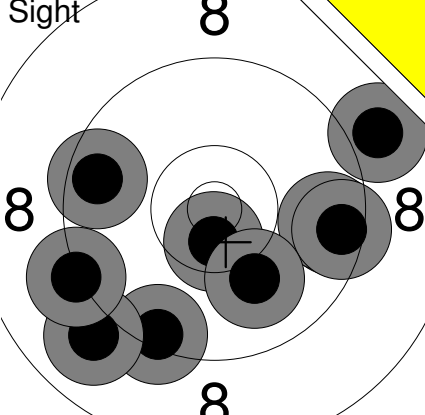
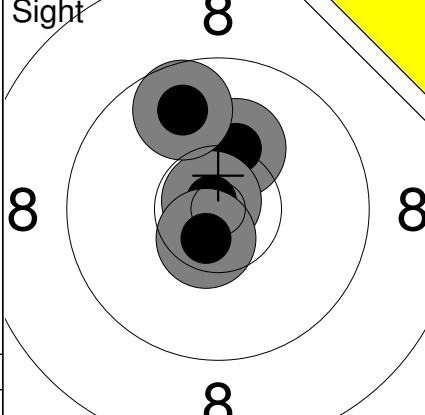
Sight 	1: 9.4	↘	Sight 	11: 10.2	↗
	2: 9.6	↖		12: 10.8x	↖
	3: 9.6	→		13: 10.6x	↘
	4: 9.7	→		14: 9.8	↗
	5: 9.5	→			
	6: 8.9	↗			
	7: 10.6x	↘			
	8: 9.0	↖			
	9: 9.2	↖			
	10: 10.0	↘			
	Series	91 ( 1x)		Series	39 ( 2x)
		0 ( 0x)			0 ( 0x)

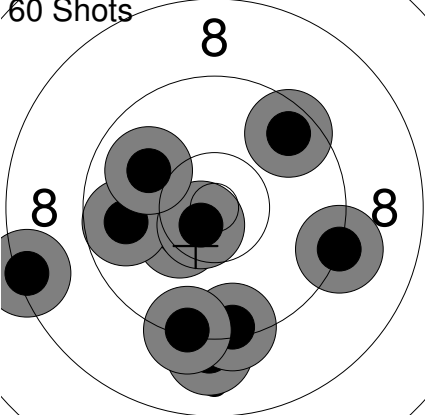
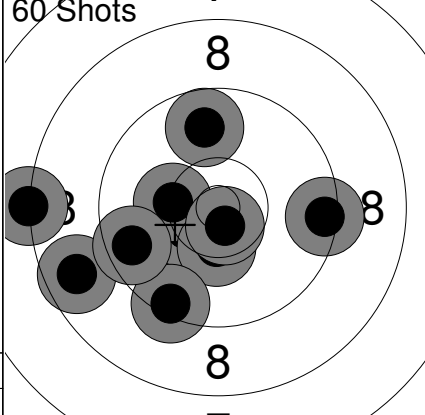
60 Shots 	1: 10.4x	↖	60 Shots 	11: 10.4x	↖
	2: 9.8	↖		12: 8.2	↖
	3: 9.6	↗		13: 10.3	↖
	4: 9.1	↘		14: 10.4x	↘
	5: 9.4	↘		15: 9.8	↗
	6: 8.4	↖		16: 9.4	↘
	7: 9.2	↗		17: 8.7	↖
	8: 9.3	↘		18: 9.4	→
	9: 10.7x	↘		19: 10.7x	↘
	10: 10.0	↗		20: 9.6	↖
	Series	92 ( 2x)		Series	92 ( 3x)
		92 ( 2x)			184 ( 5x)

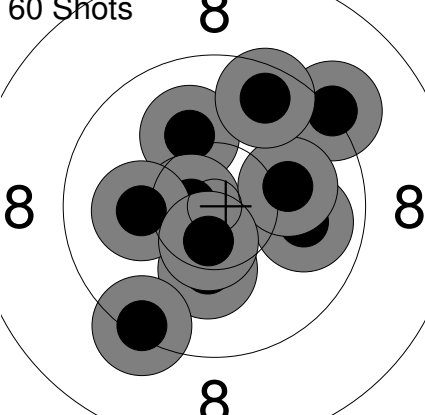
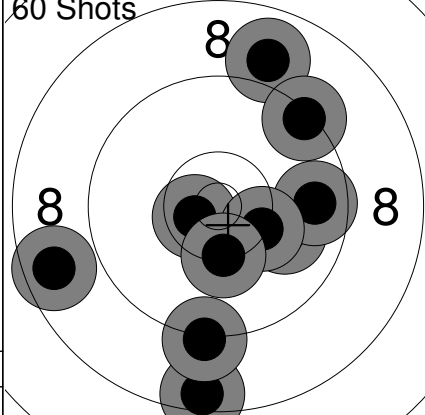
60 Shots 	21: 10.2	↘	60 Shots 	31: 8.5	↘
	22: 9.2	↗		32: 10.6x	↖
	23: 10.1	↗		33: 8.6	↖
	24: 10.7x	↖		34: 8.9	↗
	25: 9.9	→		35: 9.2	↘
	26: 10.1	→		36: 10.0	→
	27: 10.1	↖		37: 9.7	→
	28: 9.4	↘		38: 9.3	↗
	29: 10.5x	↘		39: 10.3	→
	30: 9.6	↗		40: 10.3	↘
	Series	96 ( 2x)		Series	91 ( 1x)
		280 ( 7x)			371 ( 8x)

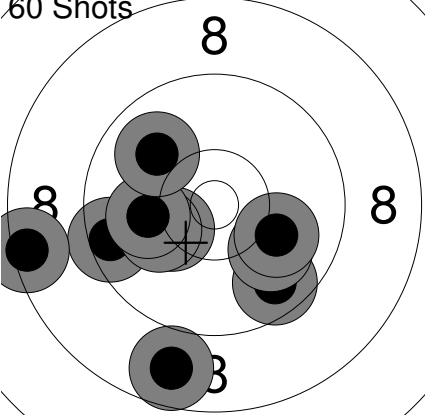
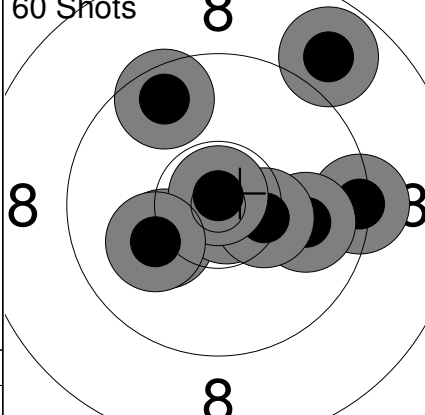
60 Shots 	41: 9.5	↖	60 Shots 	51: 9.3	→
	42: 10.3	↖		52: 9.9	→
	43: 10.2	↖		53: 10.9x	→
	44: 8.7	↘		54: 8.9	↗
	45: 9.7	↘		55: 10.2	↖
	46: 8.4	↖		56: 9.6	↗
	47: 10.0	↘		57: 10.8x	↘
	48: 10.0	↘		58: 10.4x	→
	49: 10.1	↖		59: 10.8x	↗
	50: 9.9	↗		60: 10.1	↖
	Series	93 ( 0x)		Series	95 ( 4x)
		464 ( 8x)			559 ( 12x)





Relay <b>1</b>	Lane <b>9</b>	<b>KOZIC Igor</b>
-------------------	------------------	-------------------

2023 SFC Pistol Nationals	ON	MA	MP
---------------------------	----	----	----

16.07.2023	23PN-AP-Q2	Alberta Handgun Association
------------	------------	-----------------------------

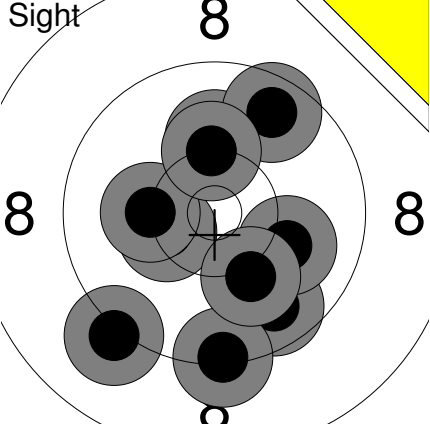
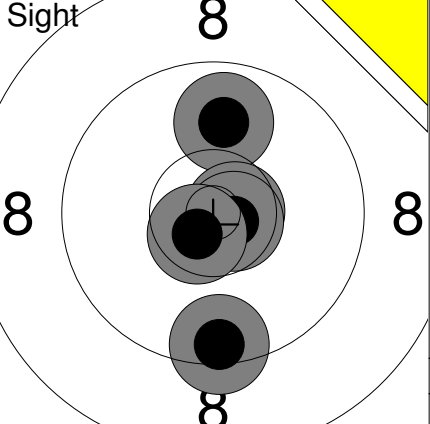
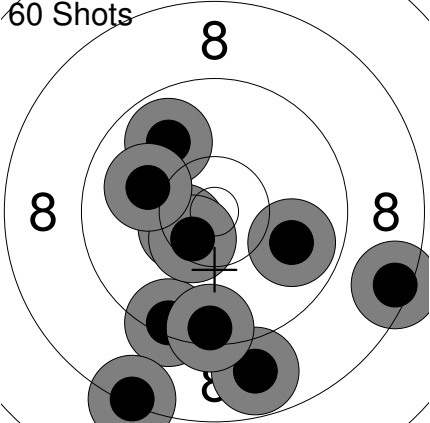
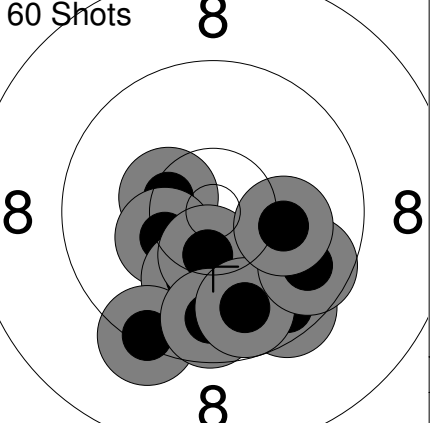
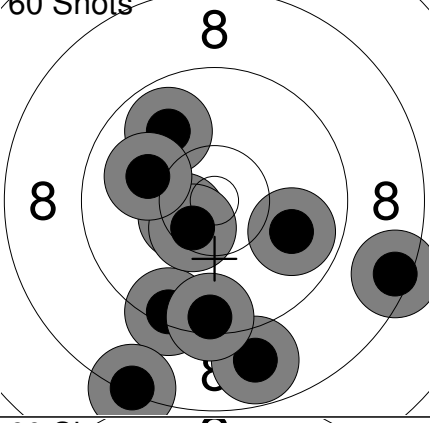
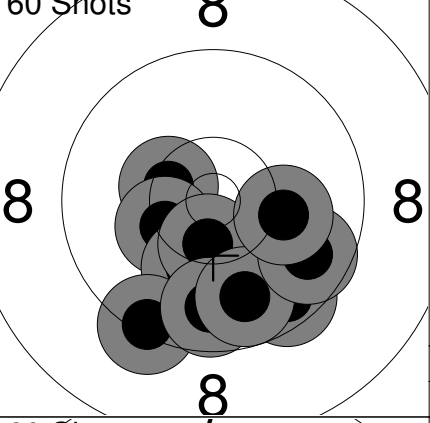
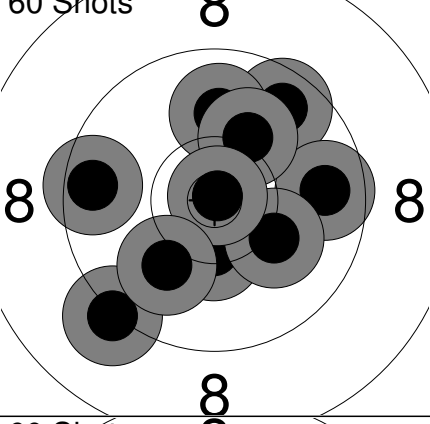
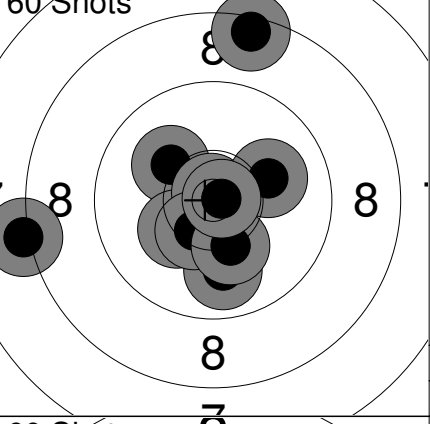
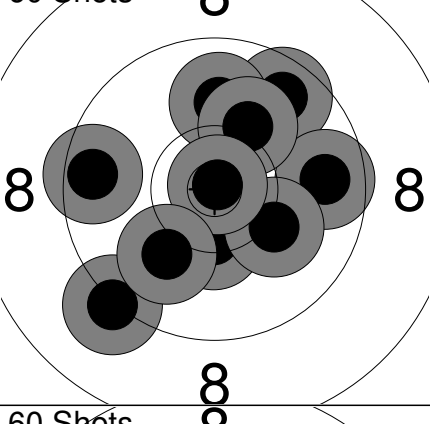
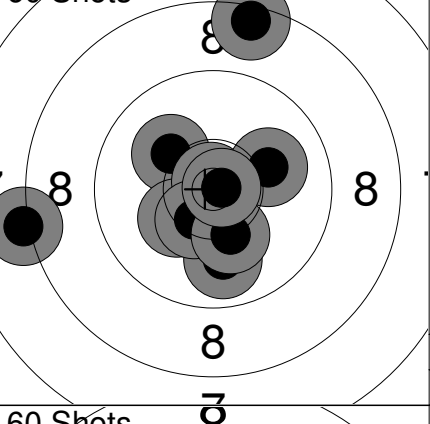
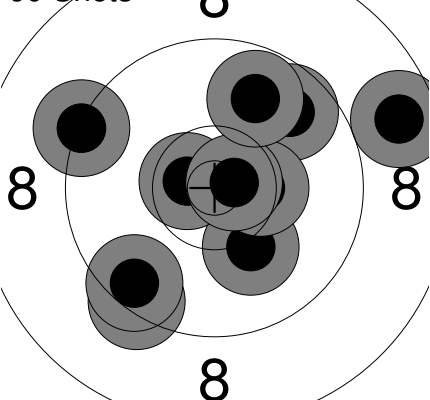
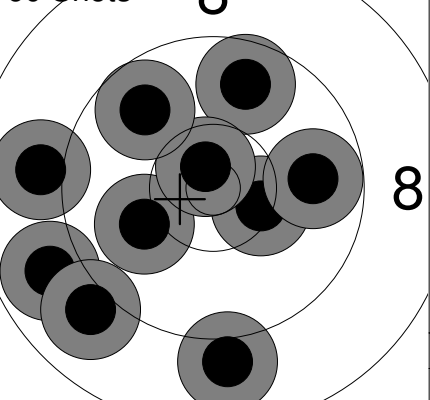
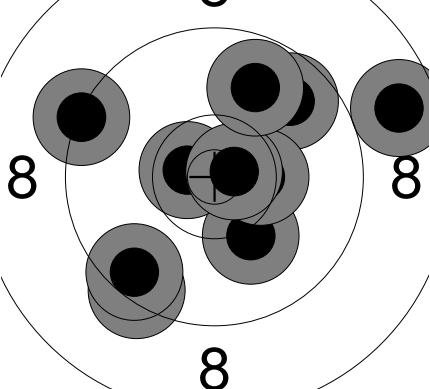
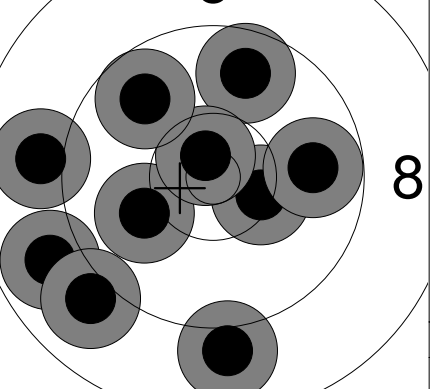
Comment	Signature
---------	-----------

Sight	Sight	Sight	Sight																																																																						
																																																																									
<table border="1" style="width:100%; border-collapse: collapse;"> <tr><td style="width:5%;">1:</td><td style="width:15%;">9.7</td><td style="width:5%;">↓</td></tr> <tr><td>2:</td><td>10.0</td><td>→</td></tr> <tr><td>3:</td><td>10.4x</td><td>←</td></tr> <tr><td>4:</td><td>10.2</td><td>←</td></tr> <tr><td>5:</td><td>10.1</td><td>↑</td></tr> <tr><td>6:</td><td>9.6</td><td>↗</td></tr> <tr><td>7:</td><td>10.2</td><td>↑</td></tr> <tr><td>8:</td><td>9.1</td><td>↓</td></tr> <tr><td>9:</td><td>9.3</td><td>↓</td></tr> <tr><td>10:</td><td>10.1</td><td>↓</td></tr> <tr><td colspan="2">Series</td><td>96 ( 1x)</td></tr> <tr><td colspan="2"></td><td>0 ( 0x)</td></tr> </table>	1:	9.7	↓	2:	10.0	→	3:	10.4x	←	4:	10.2	←	5:	10.1	↑	6:	9.6	↗	7:	10.2	↑	8:	9.1	↓	9:	9.3	↓	10:	10.1	↓	Series		96 ( 1x)			0 ( 0x)	<table border="1" style="width:100%; border-collapse: collapse;"> <tr><td style="width:5%;">11:</td><td style="width:15%;">9.5</td><td style="width:5%;">↓</td></tr> <tr><td>12:</td><td>9.9</td><td>↑</td></tr> <tr><td>13:</td><td>10.7x</td><td>→</td></tr> <tr><td>14:</td><td>10.7x</td><td>→</td></tr> <tr><td>15:</td><td>10.6x</td><td>↘</td></tr> <tr><td colspan="2">Series</td><td>48 ( 3x)</td></tr> <tr><td colspan="2"></td><td>0 ( 0x)</td></tr> </table>	11:	9.5	↓	12:	9.9	↑	13:	10.7x	→	14:	10.7x	→	15:	10.6x	↘	Series		48 ( 3x)			0 ( 0x)															
1:	9.7	↓																																																																							
2:	10.0	→																																																																							
3:	10.4x	←																																																																							
4:	10.2	←																																																																							
5:	10.1	↑																																																																							
6:	9.6	↗																																																																							
7:	10.2	↑																																																																							
8:	9.1	↓																																																																							
9:	9.3	↓																																																																							
10:	10.1	↓																																																																							
Series		96 ( 1x)																																																																							
		0 ( 0x)																																																																							
11:	9.5	↓																																																																							
12:	9.9	↑																																																																							
13:	10.7x	→																																																																							
14:	10.7x	→																																																																							
15:	10.6x	↘																																																																							
Series		48 ( 3x)																																																																							
		0 ( 0x)																																																																							
60 Shots	60 Shots	60 Shots	60 Shots																																																																						
																																																																									
<table border="1" style="width:100%; border-collapse: collapse;"> <tr><td style="width:5%;">1:</td><td style="width:15%;">9.4</td><td style="width:5%;">↓</td></tr> <tr><td>2:</td><td>10.5x</td><td>←</td></tr> <tr><td>3:</td><td>10.5x</td><td>←</td></tr> <tr><td>4:</td><td>8.4</td><td>→</td></tr> <tr><td>5:</td><td>9.9</td><td>↗</td></tr> <tr><td>6:</td><td>8.3</td><td>↓</td></tr> <tr><td>7:</td><td>8.8</td><td>↓</td></tr> <tr><td>8:</td><td>9.4</td><td>↓</td></tr> <tr><td>9:</td><td>9.9</td><td>→</td></tr> <tr><td>10:</td><td>10.0</td><td>←</td></tr> <tr><td colspan="2">Series</td><td>90 ( 2x)</td></tr> <tr><td colspan="2"></td><td>90 ( 2x)</td></tr> </table>	1:	9.4	↓	2:	10.5x	←	3:	10.5x	←	4:	8.4	→	5:	9.9	↗	6:	8.3	↓	7:	8.8	↓	8:	9.4	↓	9:	9.9	→	10:	10.0	←	Series		90 ( 2x)			90 ( 2x)	<table border="1" style="width:100%; border-collapse: collapse;"> <tr><td style="width:5%;">11:</td><td style="width:15%;">10.4x</td><td style="width:5%;">←</td></tr> <tr><td>12:</td><td>10.3</td><td>←</td></tr> <tr><td>13:</td><td>10.2</td><td>↓</td></tr> <tr><td>14:</td><td>9.6</td><td>↘</td></tr> <tr><td>15:</td><td>9.4</td><td>↘</td></tr> <tr><td>16:</td><td>10.5x</td><td>↓</td></tr> <tr><td>17:</td><td>9.7</td><td>↓</td></tr> <tr><td>18:</td><td>9.8</td><td>↓</td></tr> <tr><td>19:</td><td>9.7</td><td>↘</td></tr> <tr><td>20:</td><td>10.1</td><td>→</td></tr> <tr><td colspan="2">Series</td><td>95 ( 2x)</td></tr> <tr><td colspan="2"></td><td>185 ( 4x)</td></tr> </table>	11:	10.4x	←	12:	10.3	←	13:	10.2	↓	14:	9.6	↘	15:	9.4	↘	16:	10.5x	↓	17:	9.7	↓	18:	9.8	↓	19:	9.7	↘	20:	10.1	→	Series		95 ( 2x)			185 ( 4x)
1:	9.4	↓																																																																							
2:	10.5x	←																																																																							
3:	10.5x	←																																																																							
4:	8.4	→																																																																							
5:	9.9	↗																																																																							
6:	8.3	↓																																																																							
7:	8.8	↓																																																																							
8:	9.4	↓																																																																							
9:	9.9	→																																																																							
10:	10.0	←																																																																							
Series		90 ( 2x)																																																																							
		90 ( 2x)																																																																							
11:	10.4x	←																																																																							
12:	10.3	←																																																																							
13:	10.2	↓																																																																							
14:	9.6	↘																																																																							
15:	9.4	↘																																																																							
16:	10.5x	↓																																																																							
17:	9.7	↓																																																																							
18:	9.8	↓																																																																							
19:	9.7	↘																																																																							
20:	10.1	→																																																																							
Series		95 ( 2x)																																																																							
		185 ( 4x)																																																																							
60 Shots	60 Shots	60 Shots	60 Shots																																																																						
																																																																									
<table border="1" style="width:100%; border-collapse: collapse;"> <tr><td style="width:5%;">21:</td><td style="width:15%;">9.6</td><td style="width:5%;">↗</td></tr> <tr><td>22:</td><td>10.0</td><td>↑</td></tr> <tr><td>23:</td><td>10.4x</td><td>↓</td></tr> <tr><td>24:</td><td>9.6</td><td>←</td></tr> <tr><td>25:</td><td>9.7</td><td>→</td></tr> <tr><td>26:</td><td>10.1</td><td>↘</td></tr> <tr><td>27:</td><td>9.2</td><td>↘</td></tr> <tr><td>28:</td><td>10.1</td><td>↗</td></tr> <tr><td>29:</td><td>10.9x</td><td>↗</td></tr> <tr><td>30:</td><td>10.0</td><td>↘</td></tr> <tr><td colspan="2">Series</td><td>96 ( 2x)</td></tr> <tr><td colspan="2"></td><td>281 ( 6x)</td></tr> </table>	21:	9.6	↗	22:	10.0	↑	23:	10.4x	↓	24:	9.6	←	25:	9.7	→	26:	10.1	↘	27:	9.2	↘	28:	10.1	↗	29:	10.9x	↗	30:	10.0	↘	Series		96 ( 2x)			281 ( 6x)	<table border="1" style="width:100%; border-collapse: collapse;"> <tr><td style="width:5%;">31:</td><td style="width:15%;">10.1</td><td style="width:5%;">↖</td></tr> <tr><td>32:</td><td>10.3</td><td>↘</td></tr> <tr><td>33:</td><td>9.9</td><td>↓</td></tr> <tr><td>34:</td><td>10.8x</td><td>↑</td></tr> <tr><td>35:</td><td>8.1</td><td>←</td></tr> <tr><td>36:</td><td>10.1</td><td>→</td></tr> <tr><td>37:</td><td>10.4x</td><td>↘</td></tr> <tr><td>38:</td><td>10.2</td><td>↓</td></tr> <tr><td>39:</td><td>10.8x</td><td>→</td></tr> <tr><td>40:</td><td>8.5</td><td>↑</td></tr> <tr><td colspan="2">Series</td><td>95 ( 3x)</td></tr> <tr><td colspan="2"></td><td>376 ( 9x)</td></tr> </table>	31:	10.1	↖	32:	10.3	↘	33:	9.9	↓	34:	10.8x	↑	35:	8.1	←	36:	10.1	→	37:	10.4x	↘	38:	10.2	↓	39:	10.8x	→	40:	8.5	↑	Series		95 ( 3x)			376 ( 9x)
21:	9.6	↗																																																																							
22:	10.0	↑																																																																							
23:	10.4x	↓																																																																							
24:	9.6	←																																																																							
25:	9.7	→																																																																							
26:	10.1	↘																																																																							
27:	9.2	↘																																																																							
28:	10.1	↗																																																																							
29:	10.9x	↗																																																																							
30:	10.0	↘																																																																							
Series		96 ( 2x)																																																																							
		281 ( 6x)																																																																							
31:	10.1	↖																																																																							
32:	10.3	↘																																																																							
33:	9.9	↓																																																																							
34:	10.8x	↑																																																																							
35:	8.1	←																																																																							
36:	10.1	→																																																																							
37:	10.4x	↘																																																																							
38:	10.2	↓																																																																							
39:	10.8x	→																																																																							
40:	8.5	↑																																																																							
Series		95 ( 3x)																																																																							
		376 ( 9x)																																																																							
60 Shots	60 Shots	60 Shots	60 Shots																																																																						
																																																																									
<table border="1" style="width:100%; border-collapse: collapse;"> <tr><td style="width:5%;">41:</td><td style="width:15%;">9.4</td><td style="width:5%;">↘</td></tr> <tr><td>42:</td><td>10.2</td><td>↓</td></tr> <tr><td>43:</td><td>8.7</td><td>→</td></tr> <tr><td>44:</td><td>10.6x</td><td>←</td></tr> <tr><td>45:</td><td>9.3</td><td>←</td></tr> <tr><td>46:</td><td>9.7</td><td>↗</td></tr> <tr><td>47:</td><td>10.4x</td><td>→</td></tr> <tr><td>48:</td><td>10.7x</td><td>→</td></tr> <tr><td>49:</td><td>9.8</td><td>↗</td></tr> <tr><td>50:</td><td>9.5</td><td>↘</td></tr> <tr><td colspan="2">Series</td><td>93 ( 3x)</td></tr> <tr><td colspan="2"></td><td>469 ( 12x)</td></tr> </table>	41:	9.4	↘	42:	10.2	↓	43:	8.7	→	44:	10.6x	←	45:	9.3	←	46:	9.7	↗	47:	10.4x	→	48:	10.7x	→	49:	9.8	↗	50:	9.5	↘	Series		93 ( 3x)			469 ( 12x)	<table border="1" style="width:100%; border-collapse: collapse;"> <tr><td style="width:5%;">51:</td><td style="width:15%;">8.9</td><td style="width:5%;">←</td></tr> <tr><td>52:</td><td>9.7</td><td>↑</td></tr> <tr><td>53:</td><td>10.1</td><td>←</td></tr> <tr><td>54:</td><td>9.0</td><td>↘</td></tr> <tr><td>55:</td><td>10.4x</td><td>→</td></tr> <tr><td>56:</td><td>10.7x</td><td>↑</td></tr> <tr><td>57:</td><td>9.0</td><td>←</td></tr> <tr><td>58:</td><td>9.0</td><td>↓</td></tr> <tr><td>59:</td><td>9.8</td><td>→</td></tr> <tr><td>60:</td><td>9.8</td><td>↖</td></tr> <tr><td colspan="2">Series</td><td>92 ( 2x)</td></tr> <tr><td colspan="2"></td><td>561 ( 14x)</td></tr> </table>	51:	8.9	←	52:	9.7	↑	53:	10.1	←	54:	9.0	↘	55:	10.4x	→	56:	10.7x	↑	57:	9.0	←	58:	9.0	↓	59:	9.8	→	60:	9.8	↖	Series		92 ( 2x)			561 ( 14x)
41:	9.4	↘																																																																							
42:	10.2	↓																																																																							
43:	8.7	→																																																																							
44:	10.6x	←																																																																							
45:	9.3	←																																																																							
46:	9.7	↗																																																																							
47:	10.4x	→																																																																							
48:	10.7x	→																																																																							
49:	9.8	↗																																																																							
50:	9.5	↘																																																																							
Series		93 ( 3x)																																																																							
		469 ( 12x)																																																																							
51:	8.9	←																																																																							
52:	9.7	↑																																																																							
53:	10.1	←																																																																							
54:	9.0	↘																																																																							
55:	10.4x	→																																																																							
56:	10.7x	↑																																																																							
57:	9.0	←																																																																							
58:	9.0	↓																																																																							
59:	9.8	→																																																																							
60:	9.8	↖																																																																							
Series		92 ( 2x)																																																																							
		561 ( 14x)																																																																							



Relay <b>1</b>	Lane <b>10</b>	<b>OZER Tugrul</b>	
-------------------	-------------------	--------------------	--

2023 SFC Pistol Nationals	AB	MA	MP
---------------------------	----	----	----

16.07.2023	23PN-AP-Q2	Alberta Handgun Association	
------------	------------	-----------------------------	--

Comment	Signature		
---------	-----------	--	--

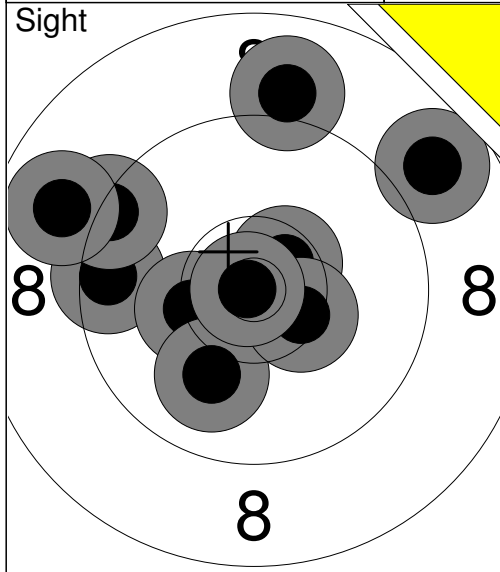

1:	9.5	←
2:	10.3	←
3:	9.3	↗
4:	8.9	←
5:	10.5x	↗
6:	9.0	↑
7:	8.8	↗
8:	10.0	↓
9:	10.4x	↘
10:	10.9x	←
Series	93 ( 3x)	
	0 ( 0x)	

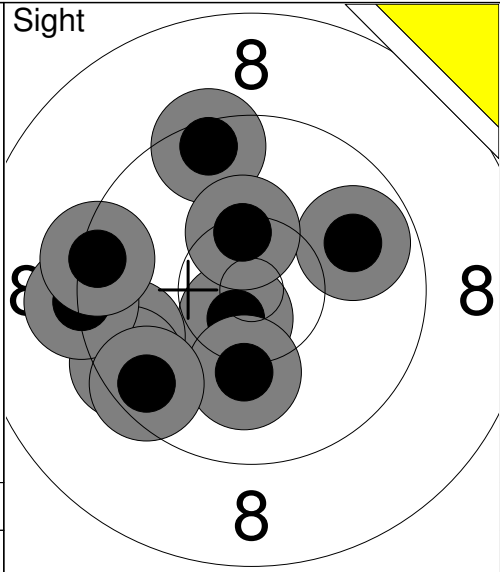

11:	9.5	↑
12:	10.6x	↓
13:	9.9	↗
14:	9.6	←
15:	10.1	↓
16:	9.5	←
17:	9.3	←
18:	10.4x	↑
19:	9.4	←
20:	9.6	↓
Series	93 ( 2x)	
	0 ( 0x)	

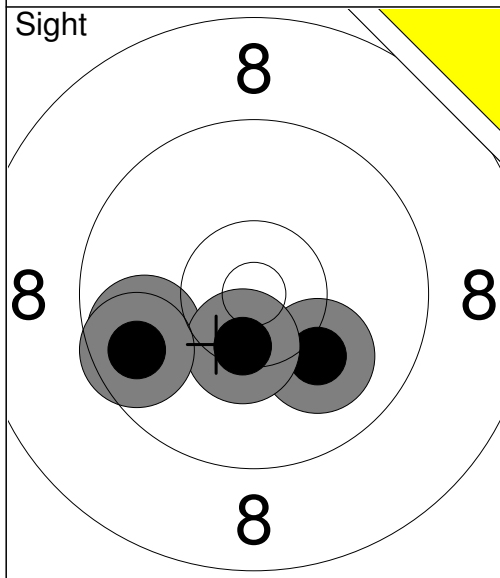

21:	9.8	←
22:	10.1	↘
23:	10.4x	↓
24:	9.7	←
Series	38 ( 1x)	
	0 ( 0x)	

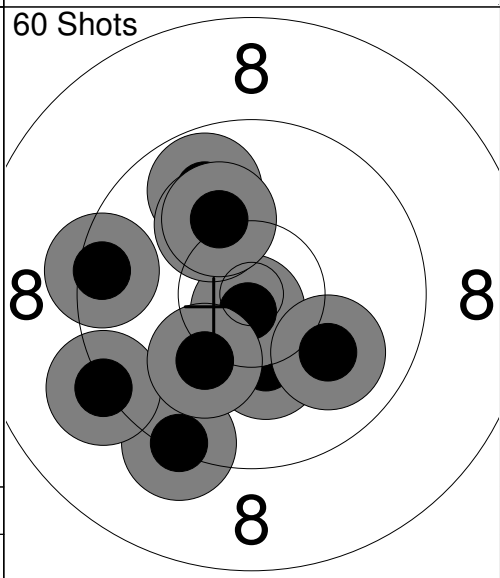

1:	10.3	↓
2:	10.8x	↓
3:	10.0	↘
4:	9.8	↗
5:	10.2	↗
6:	9.5	←
7:	10.1	↗
8:	9.3	↓
9:	9.2	←
10:	10.1	↓
Series	96 ( 1x)	
	96 ( 1x)	

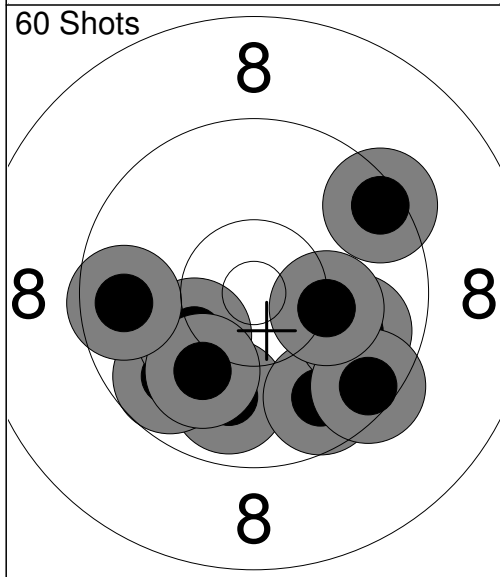

11:	9.9	↓
12:	9.4	↗
13:	9.7	↘
14:	9.8	←
15:	10.2	←
16:	9.9	↘
17:	9.5	↘
18:	10.2	↘
19:	10.0	↓
20:	9.7	←
Series	93 ( 0x)	
	189 ( 1x)	

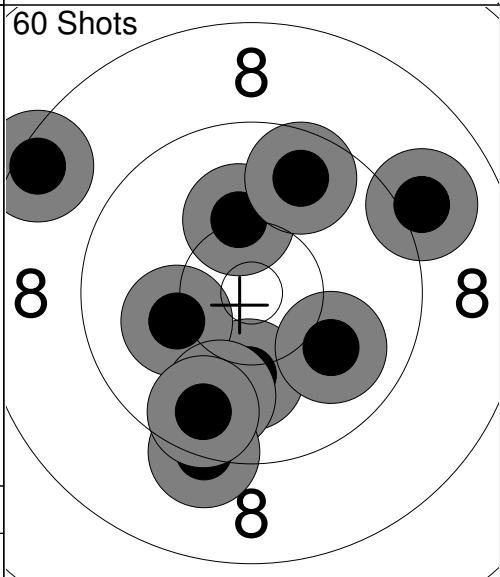

21:	9.0	↗
22:	10.1	↓
23:	10.2	↑
24:	8.5	↖
25:	10.0	↘
26:	10.1	←
27:	9.9	↓
28:	9.3	↓
29:	9.7	↓
30:	9.7	↑
Series	93 ( 0x)	
	282 ( 1x)	

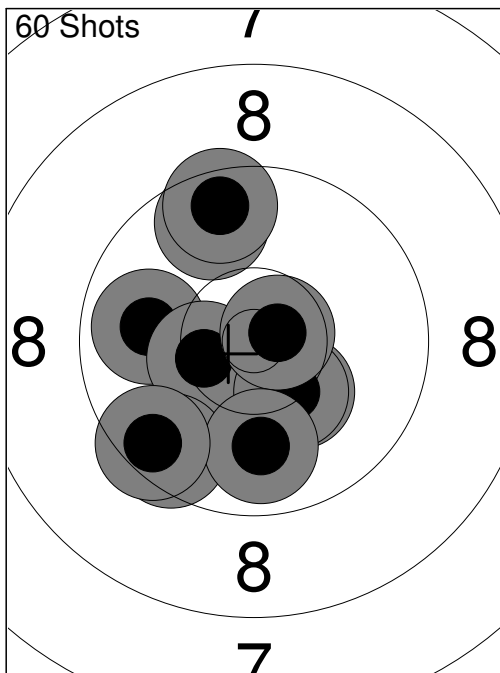

31:	9.9	←
32:	10.3	↘
33:	9.7	↗
34:	9.6	↑
35:	10.4x	←
36:	10.3	↘
37:	10.7x	→
38:	9.6	↘
39:	9.9	↓
40:	9.5	↙
Series	94 ( 2x)	
	376 ( 3x)	

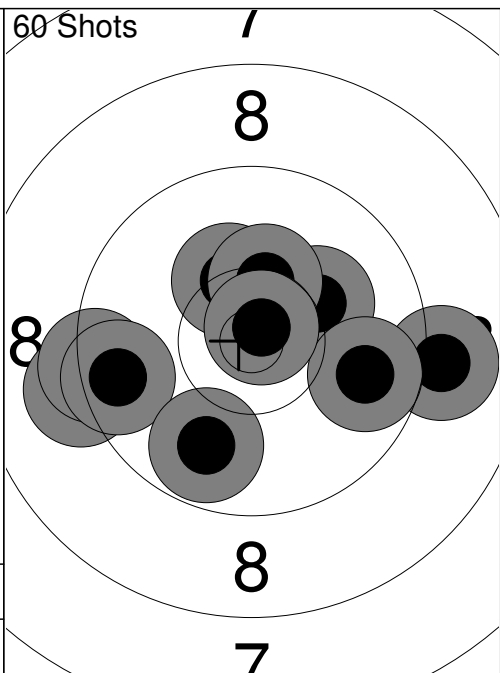

41:	9.1	→
42:	10.3	↗
43:	9.2	←
44:	10.2	↗
45:	9.4	←
46:	9.6	←
47:	9.8	→
48:	9.8	↘
49:	10.3	↑
50:	10.8x	↗
Series	94 ( 1x)	
	470 ( 4x)	

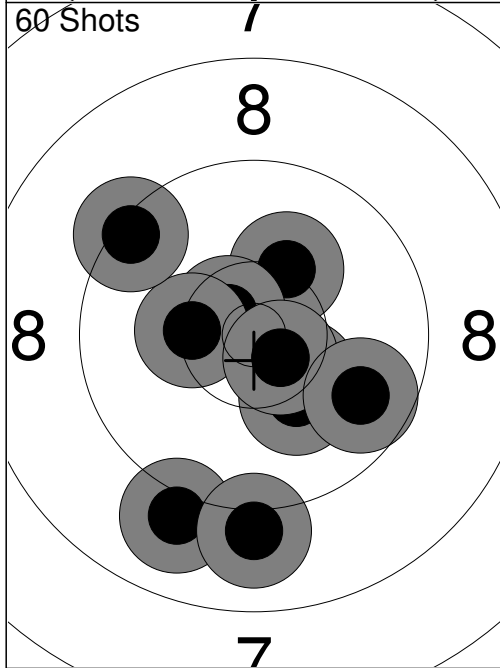

51:	10.2	↗
52:	10.3	↘
53:	10.2	↘
54:	10.6x	↗
55:	10.3	←
56:	10.6x	↘
57:	9.4	↗
58:	9.0	↘
59:	9.7	↘
60:	9.0	↓
Series	96 ( 2x)	
	566 ( 6x)	

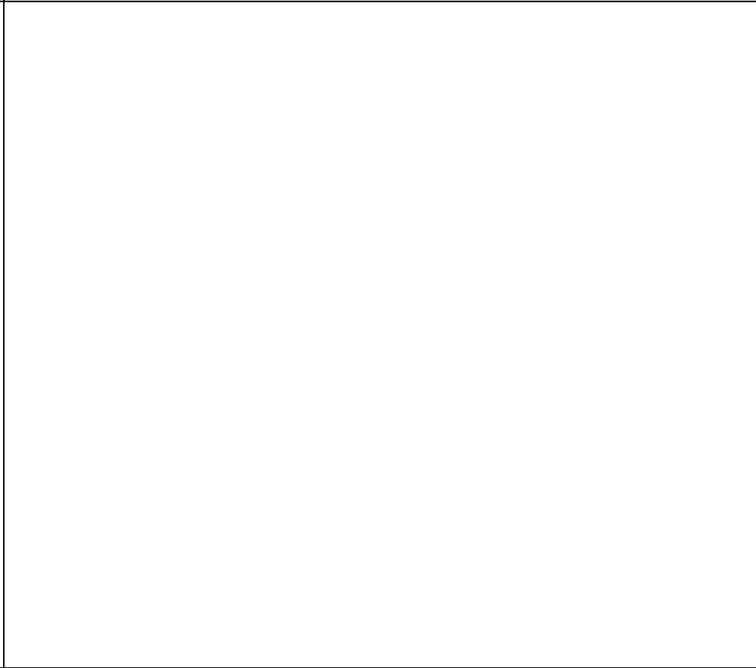
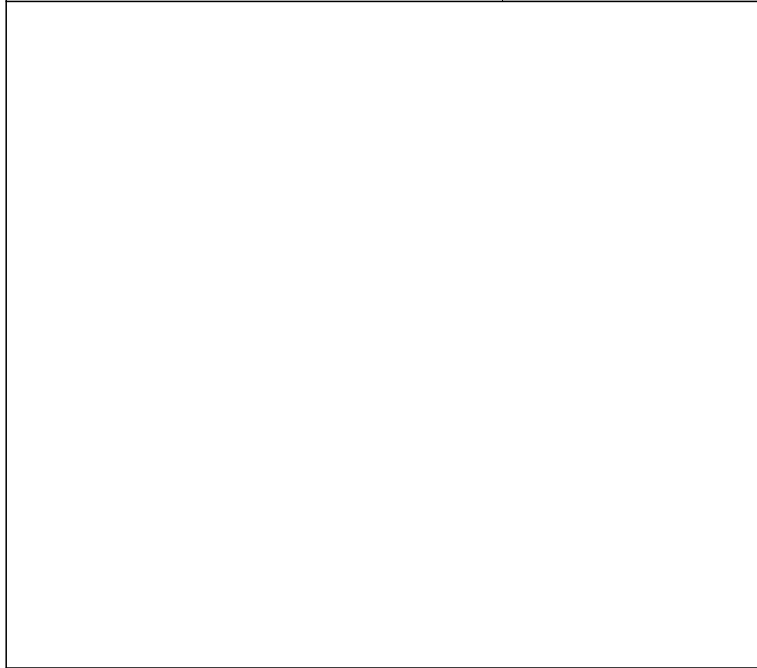

Relay <b>1</b>	Lane <b>11</b>	<b>MARKEWICZ Alan</b>
-------------------	-------------------	-----------------------

2023 SFC Pistol Nationals	AB	EX	MP
---------------------------	----	----	----

16.07.2023	23PN-AP-Q2	Alberta Handgun Association
------------	------------	-----------------------------

Comment	Signature
---------	-----------

<b>Sight</b> 	1: 9.8 ↙ 2: 9.2 → 3: 10.0 ↓ 4: 9.7 ↗ 5: 10.1 ↖ 6: 9.4 ↗ 7: 6.6 ← 8: 8.8 → 9: 10.2 ← 10: 9.6 ↖	<b>60 Shots</b> 	1: 9.7 ↓ 2: 10.4x ← 3: 10.5x ↗ 4: 10.5x ↓ 5: 10.4x ↖ 6: 10.5x ↓ 7: 10.5x ↓ 8: 8.0 ← 9: 10.2 ↖ 10: 10.5x ↖
	Series 89 (0x) 0 (0x)		Series 97 (7x) 97 (7x)
<b>60 Shots</b> 	11: 9.3 ↙ 12: 10.0 ↓ 13: 7.7 → 14: 10.5x ↙ 15: 9.8 ↗ 16: 10.3 ← 17: 8.8 ← 18: 9.4 ← 19: 10.1 ↖ 20: 10.4x ↘	<b>60 Shots</b> 	21: 9.0 → 22: 9.5 ↙ 23: 9.2 → 24: 9.1 ← 25: 10.4x ↖ 26: 8.8 → 27: 9.4 ↖ 28: 9.4 ← 29: 10.2 ↓ 30: 9.2 ↘
	Series 92 (2x) 189 (9x)		Series 91 (1x) 280 (10x)
<b>60 Shots</b> 	31: 9.3 ↙ 32: 9.7 → 33: 9.2 ↓ 34: 9.0 ↗ 35: 10.0 ← 36: 9.8 ↖ 37: 10.2 ↘ 38: 10.2 ↘ 39: 8.9 ↖ 40: 9.0 ↖	<b>60 Shots</b> 	41: 7.7 ↖ 42: 9.2 ← 43: 9.4 ↖ 44: 9.6 ↖ 45: 8.4 ↓ 46: 8.8 ↖ 47: 8.9 ↖ 48: 9.2 ← 49: 9.8 ↘ 50: 9.9 ↖
	Series 92 (0x) 372 (10x)		Series 85 (0x) 457 (10x)
<b>60 Shots</b> 	51: 9.4 ← 52: 9.4 ← 53: 9.6 ↖ 54: 9.3 ↖ 55: 8.4 ↖ 56: 9.7 ↖ 57: 9.7 ↖ 58: 9.1 ← 59: 9.2 ↓ 60: 10.5x ↓		
	Series 90 (1x) 547 (11x)		

Relay **1** Lane **12** **LE SIEUR Francis**

2023 SFC Pistol Nationals QC EX MP

16.07.2023 23PN-AP-Q2 Alberta Handgun Association

Comment Signature

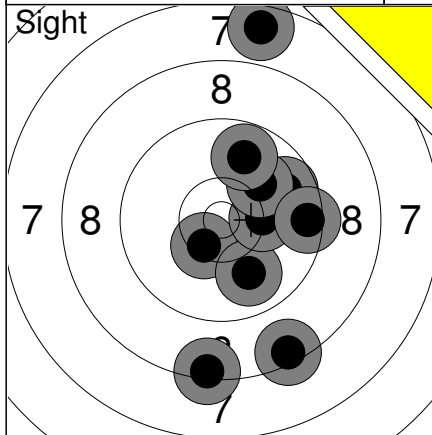

1:	9.8	→
2:	7.6	↑
3:	10.4x	↓
4:	9.9	↓
5:	8.4	↓
6:	8.4	↓
7:	10.3	→
8:	10.1	↗
9:	9.5	→
10:	9.8	↑
Series	89 (1x)	
	0 (0x)	

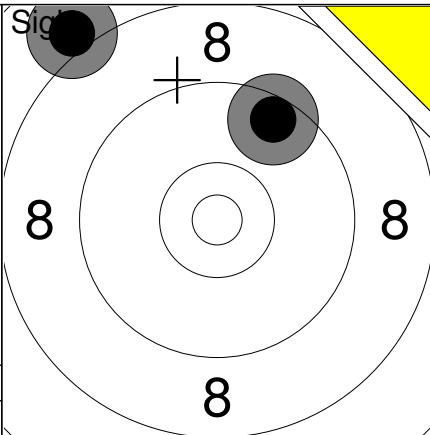

11:	8.0	↖
12:	9.5	↗
Series	17 (0x)	
	0 (0x)	

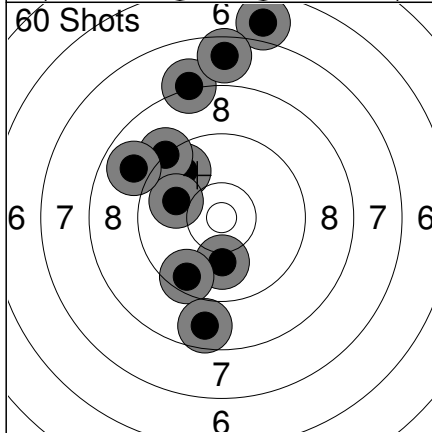

1:	8.2	↑
2:	10.0	↓
3:	6.8	↑
4:	9.7	↗
5:	9.2	↗
6:	10.0	↖
7:	9.5	↓
8:	8.7	↓
9:	8.9	↖
10:	7.6	↑
Series	84 (0x)	
	84 (0x)	

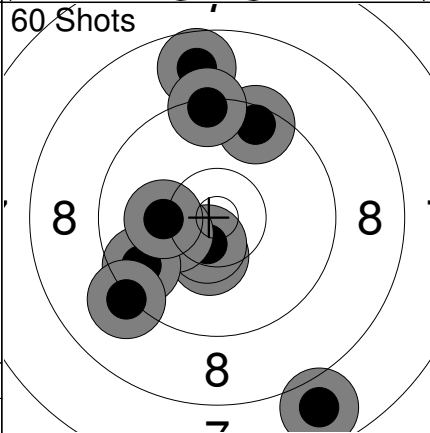

11:	8.8	↑
12:	10.4x	↓
13:	9.5	↗
14:	10.5x	↓
15:	9.3	↑
16:	10.3	←
17:	9.6	←
18:	10.2	←
19:	7.8	↓
20:	9.2	↙
Series	91 (2x)	
	175 (2x)	

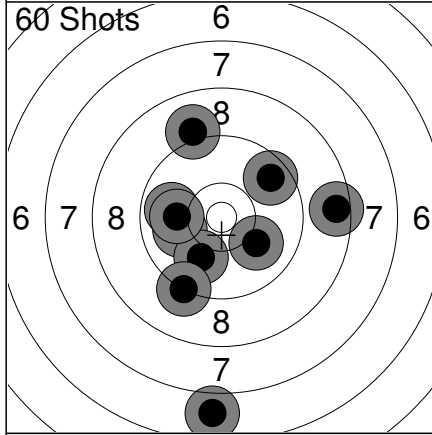

21:	6.8	↓
22:	9.1	↑
23:	10.0	←
24:	8.5	→
25:	9.6	↗
26:	9.9	←
27:	10.0	↓
28:	9.2	↓
29:	10.0	←
30:	10.0	↓
Series	90 (0x)	
	265 (2x)	

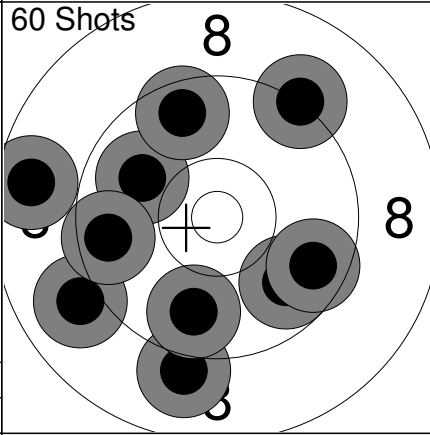

31:	9.0	↓
32:	9.8	↘
33:	9.8	↓
34:	9.9	↖
35:	9.6	↑
36:	9.0	←
37:	9.6	←
38:	9.2	↗
39:	9.6	→
40:	8.7	←
Series	89 (0x)	
	354 (2x)	

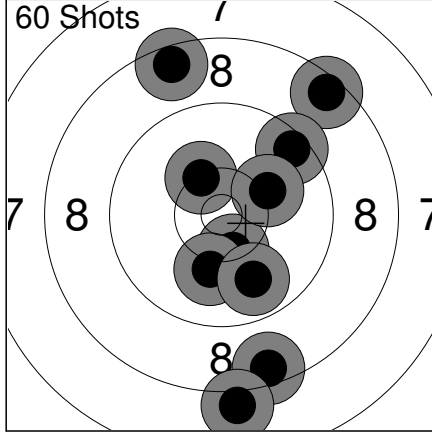

41:	10.3	↖
42:	8.5	↗
43:	8.5	↓
44:	10.4x	↓
45:	10.1	↓
46:	8.5	↗
47:	9.5	↗
48:	9.8	↓
49:	8.0	↓
50:	10.1	↗
Series	90 (1x)	
	444 (3x)	

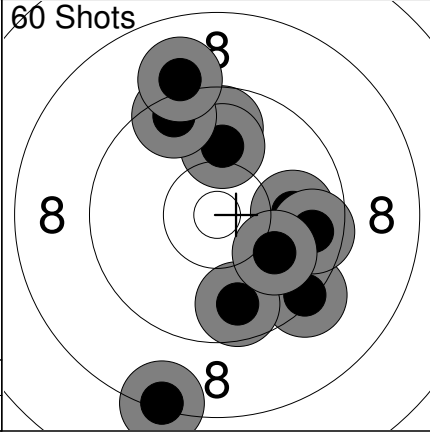

51:	9.3	↘
52:	9.8	↑
53:	10.0	↑
54:	9.7	↓
55:	9.5	↗
56:	9.9	→
57:	8.3	↓
58:	9.7	→
59:	9.1	↑
60:	10.0	↘
Series	91 (0x)	
	535 (3x)	

Relay <b>1</b>	Lane <b>13</b>	<b>OLSEN Jesse</b>
-------------------	-------------------	--------------------

2023 SFC Pistol Nationals	SK	EX	MP
---------------------------	----	----	----

16.07.2023	23PN-AP-Q2	Alberta Handgun Association
------------	------------	-----------------------------

Comment	Signature
---------	-----------

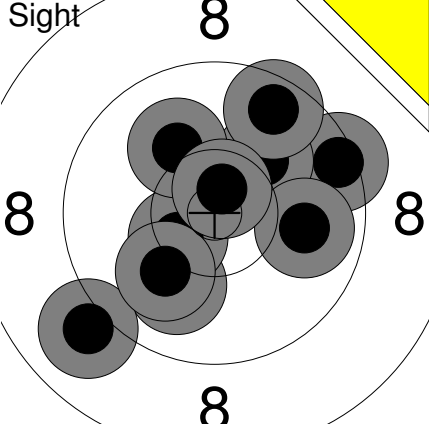
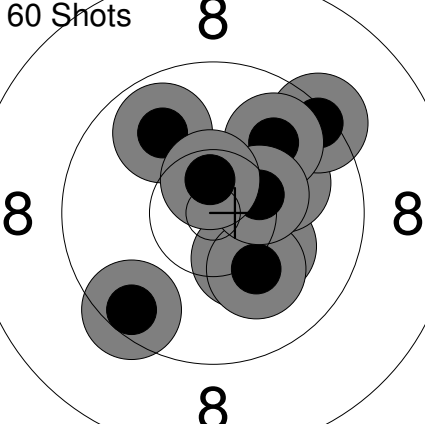
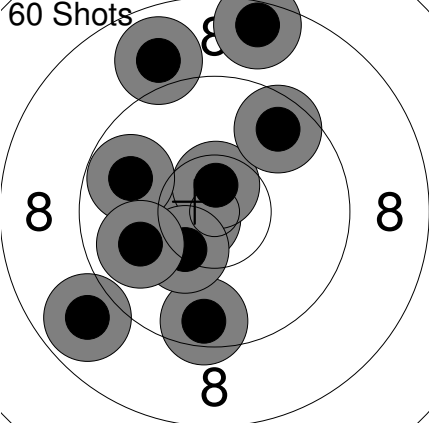
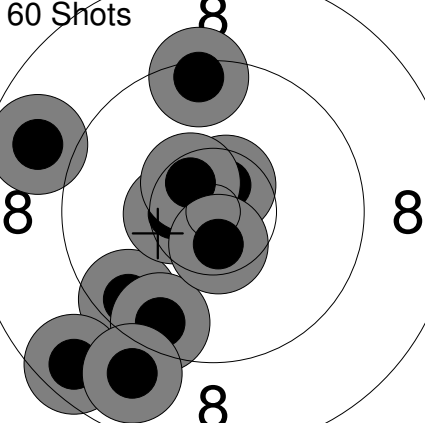
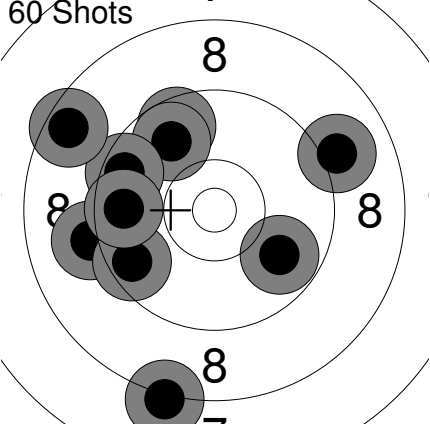
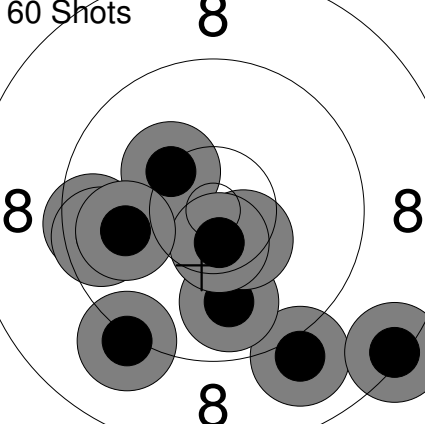
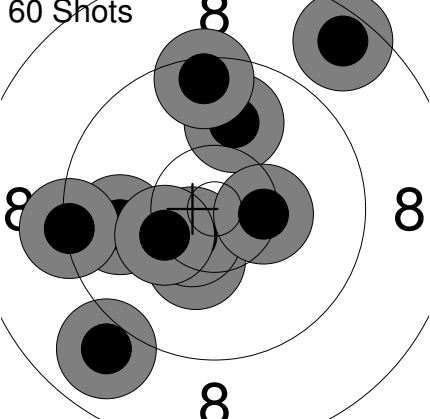
<b>Sight</b> 	1: 9.4 → 2: 10.0 ↓ 3: 9.0 ↙ 4: 10.1 ↗ 5: 10.5x ↙ 6: 10.1 ↗ 7: 10.1 ↙ 8: 9.9 → 9: 9.6 ↗ 10: 10.7x ↗	<b>60 Shots</b> 	1: 10.2 ↘ 2: 9.5 ↙ 3: 10.3 ↙ 4: 9.9 ↗ 5: 10.1 ↘ 6: 10.1 ↗ 7: 9.4 ↗ 8: 9.9 ↗ 9: 10.4x ↗ 10: 10.6x ↑
	Series 96 (2x) 0 (0x)		Series 96 (2x) 96 (2x)
<b>60 Shots</b> 	11: 9.6 ↓ 12: 10.7x ← 13: 10.6x ↑ 14: 8.5 ↑ 15: 9.6 ↗ 16: 10.3 ↙ 17: 8.9 ↗ 18: 9.8 ← 19: 9.9 ← 20: 8.9 ↙	<b>60 Shots</b> 	21: 9.6 ↘ 22: 10.6x ↗ 23: 9.4 ↑ 24: 10.5x ← 25: 9.5 ↙ 26: 10.5x ↗ 27: 10.6x ↓ 28: 8.8 ← 29: 8.6 ↘ 30: 8.9 ↙
	Series 90 (2x) 186 (4x)		Series 91 (4x) 277 (8x)
<b>60 Shots</b> 	31: 9.1 ← 32: 9.6 ↗ 33: 9.8 ↗ 34: 9.0 → 35: 8.2 ↘ 36: 9.6 ← 37: 9.6 ↗ 38: 9.7 ← 39: 8.6 ↗ 40: 9.8 ↘	<b>60 Shots</b> 	41: 10.3 ↗ 42: 9.0 ↘ 43: 9.9 ↘ 44: 9.6 ← 45: 9.2 ↘ 46: 8.3 ↘ 47: 10.5x ↘ 48: 10.6x ↘ 49: 9.6 ← 50: 9.9 ←
	Series 88 (0x) 365 (8x)		Series 92 (2x) 457 (10x)
<b>60 Shots</b> 	51: 9.9 ↑ 52: 9.9 ← 53: 9.3 ← 54: 10.3 ↘ 55: 9.5 ↑ 56: 8.5 ↗ 57: 10.5x ↘ 58: 8.9 ↘ 59: 10.3 ← 60: 10.4x →		
	Series 92 (2x) 549 (12x)		

Relay <b>1</b>	Lane <b>14</b>	<b>KATZ Bob</b>
-------------------	-------------------	-----------------

2023 SFC Pistol Nationals	QC	EX	MP
---------------------------	----	----	----

16.07.2023	23PN-AP-Q2	Alberta Handgun Association
------------	------------	-----------------------------

Comment	Signature
---------	-----------

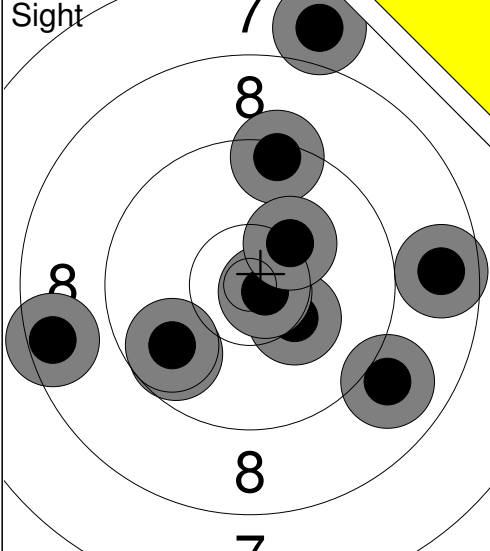
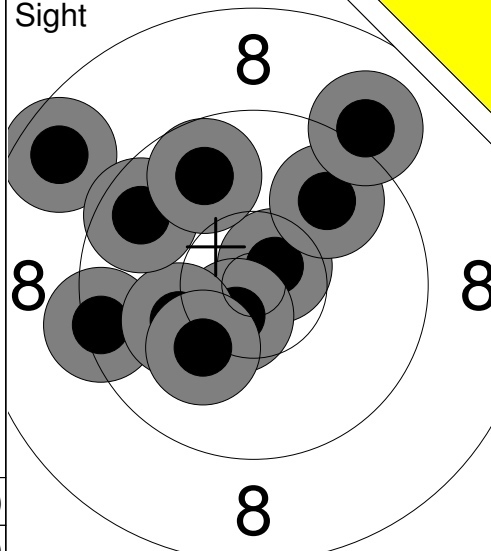
<p>Sight</p>  <p style="text-align: center;">7 8 8 8 8 8 8 7</p>	<p>1: 10.3 ↘ 2: 9.8 ↙ 3: 9.0 ↘ 4: 8.7 → 5: 10.8x ↘ 6: 9.8 ↙ 7: 9.4 ↑ 8: 10.3 ↗ 9: 8.5 ← 10: 7.8 ↑</p> <p>Series 89 ( 1x) 0 ( 0x)</p>	<p>Sight</p>  <p style="text-align: center;">8 8 8 8 8 8 8 8</p>	<p>11: 9.4 ← 12: 8.7 ↖ 13: 10.7x ↗ 14: 10.6x ↘ 15: 10.1 ← 16: 9.9 ↗ 17: 9.1 ↗ 18: 9.6 ↖ 19: 9.8 ↑ 20: 10.2 ↘</p> <p>Series 93 ( 2x) 0 ( 0x)</p>
--	--	--	---

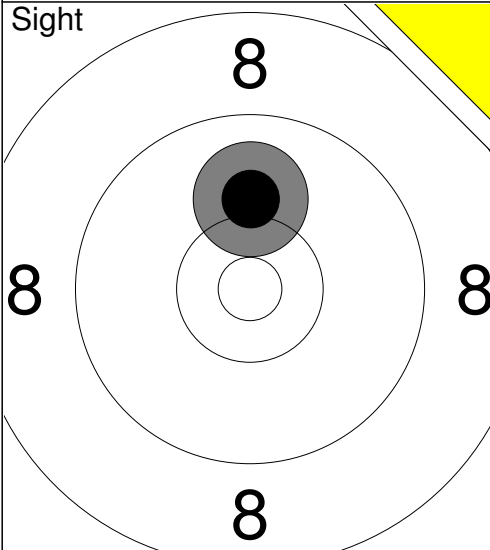
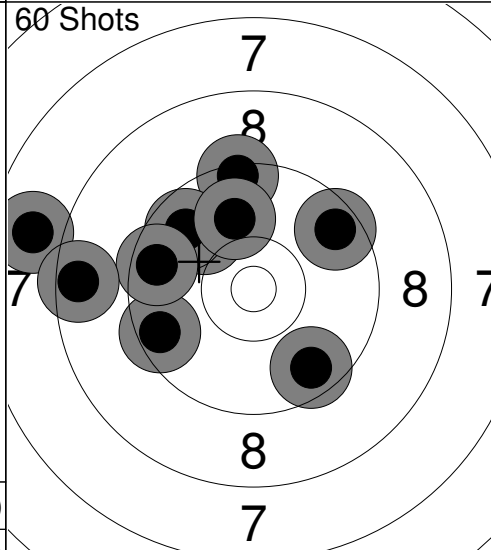
<p>Sight</p>  <p style="text-align: center;">8 8 8</p>	<p>21: 10.1 ↑</p> <p>Series 10 ( 0x) 0 ( 0x)</p>	<p>60 Shots</p>  <p style="text-align: center;">7 8 8 8 8 8 7 7</p>	<p>1: 9.5 ← 2: 9.9 ↖ 3: 9.4 ↑ 4: 9.7 ↖ 5: 10.0 ↑ 6: 7.8 ← 7: 9.6 ← 8: 9.6 ↗ 9: 8.5 ← 10: 9.6 ↘</p> <p>Series 88 ( 0x) 88 ( 0x)</p>
---	--	--	--

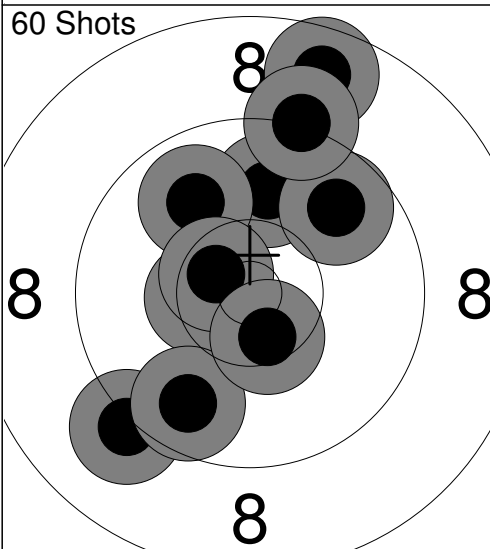
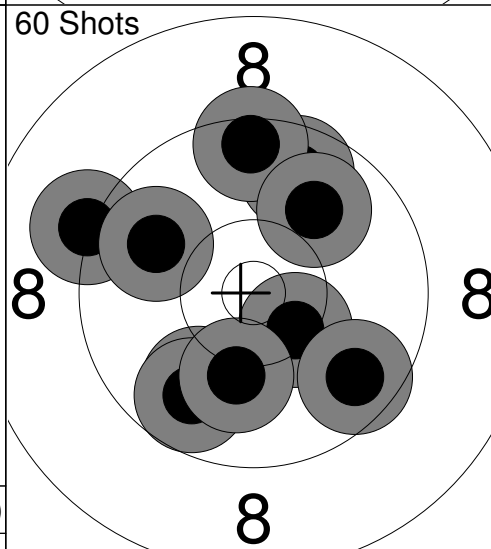
<p>60 Shots</p>  <p style="text-align: center;">8 8 8 8 8 8 8 8</p>	<p>11: 9.9 ↑ 12: 10.5x ← 13: 9.9 ↗ 14: 9.2 ↘ 15: 9.7 ↘ 16: 10.6x ↖ 17: 10.5x ↘ 18: 8.7 ↑ 19: 9.8 ↗ 20: 9.2 ↑</p> <p>Series 92 ( 3x) 180 ( 3x)</p>	<p>60 Shots</p>  <p style="text-align: center;">8 8 8 8 8 8 8 8</p>	<p>21: 9.7 ↑ 22: 10.4x ↘ 23: 9.5 ↑ 24: 9.7 ↘ 25: 9.2 ↖ 26: 9.9 ↗ 27: 9.9 ↖ 28: 9.9 ↘ 29: 9.8 ↘ 30: 10.1 ↘</p> <p>Series 92 ( 1x) 272 ( 4x)</p>
---	---	---	--



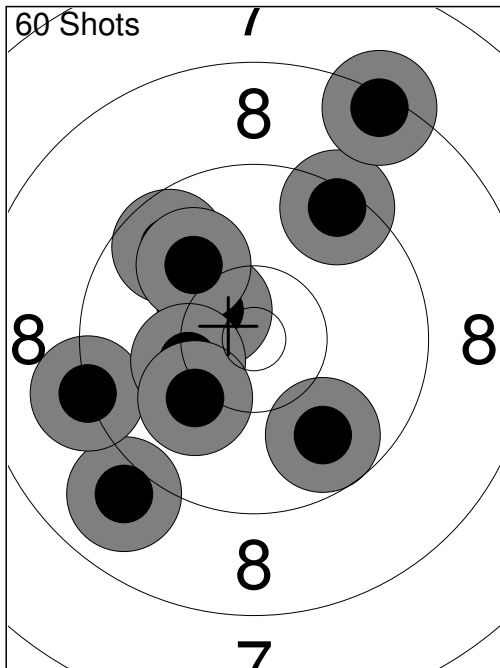

31:	10.5x ↖
32:	9.7 ↖
33:	9.0 ↙
34:	9.4 ↗
35:	9.8 ↘
36:	10.0 ↗
37:	8.4 ↗
38:	9.2 ←
39:	10.3 ←
40:	10.1 ↙
Series	93 ( 1x)
	365 ( 5x)

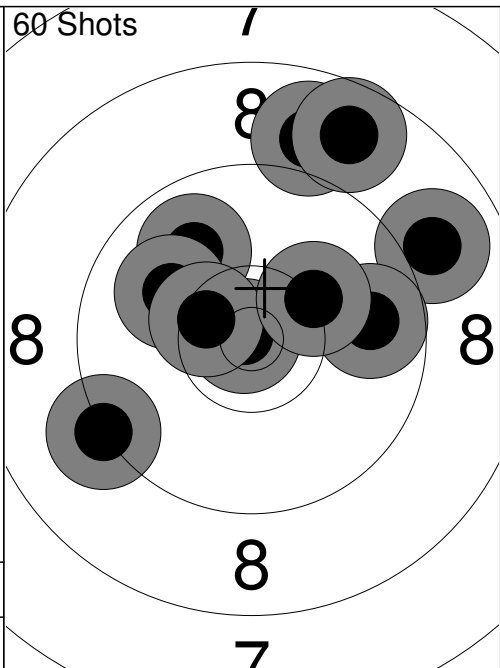

41:	8.9 ↗
42:	9.0 ↗
43:	8.7 ↗
44:	9.9 ↖
45:	10.9x ↖
46:	9.8 →
47:	10.0 ↖
48:	10.5x ↖
49:	9.2 ↙
50:	10.2 ↗
Series	92 ( 2x)
	457 ( 7x)

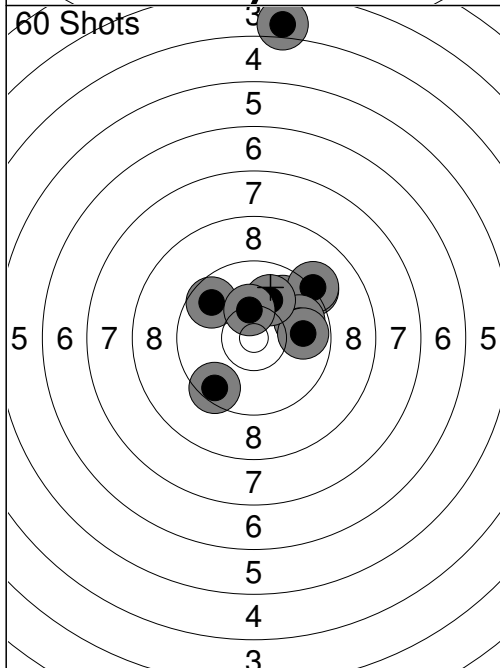

51:	9.7 ↖
52:	9.3 ↗
53:	9.5 ↙
54:	9.9 ↗
55:	3.9 ↑
56:	9.2 ↗
57:	9.9 →
58:	9.9 →
59:	10.0 ↗
60:	10.3 ↑
Series	86 ( 0x)
	543 ( 7x)

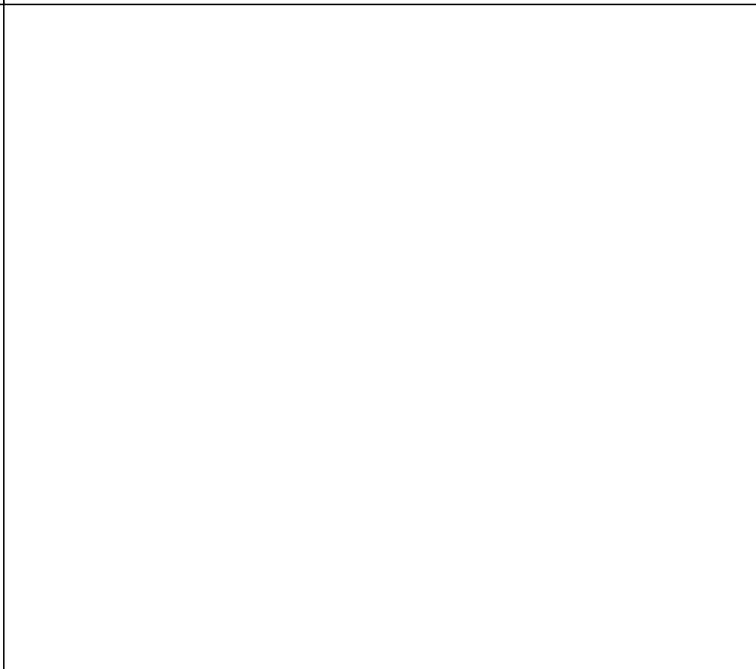
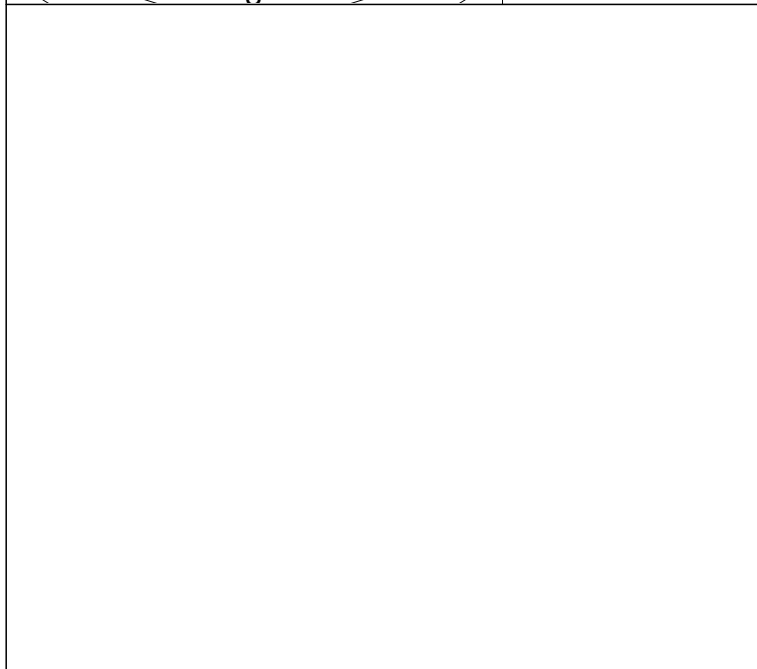

Relay **1** Lane **15** **KELLY Michael**

2023 SFC Pistol Nationals NS EX MP

16.07.2023 23PN-AP-Q2 Alberta Handgun Association

Comment Signature

	1: 10.0 → 2: 9.0 ↓ 3: 10.0 → 4: 8.8 ↓ 5: 9.6 → 6: 9.7 ↗ 7: 9.1 ↓ 8: 9.1 ↖		1: 9.7 → 2: 8.1 ↓ 3: 6.9 ↓ 4: 10.1 → 5: 9.4 ↙ 6: 9.5 ← 7: 9.2 ↗ 8: 9.1 ↗ 9: 7.8 ← 10: 9.3 ↑
	Series 73 (0x) 0 (0x)		Series 85 (0x) 85 (0x)

	11: 10.2 ↑ 12: 10.1 ↑ 13: 10.9x ↓ 14: 7.0 ↘ 15: 9.0 ← 16: 5.9 ← 17: 9.9 ↙ 18: 10.1 ↗ 19: 9.0 ↗ 20: 10.4x ←		21: 9.6 ↓ 22: 8.3 ↓ 23: 10.5x → 24: 10.3 → 25: 9.9 → 26: 8.6 ↙ 27: 10.3 ↗ 28: 8.4 → 29: 9.2 ↓ 30: 6.5 ←
	Series 89 (2x) 174 (2x)		Series 87 (1x) 261 (3x)

	31: 8.0 ↓ 32: 9.8 ↘ 33: 7.2 → 34: 9.7 ← 35: 8.6 ↓ 36: 8.7 ↘ 37: 8.2 ↘ 38: 9.5 ↗ 39: 9.4 ↓ 40: 9.4 ↙		41: 9.8 ↓ 42: 8.9 ↓ 43: 9.7 ↓ 44: 9.3 ↑ 45: 10.2 → 46: 10.2 → 47: 9.9 ↗ 48: 9.9 → 49: 10.2 ↓ 50: 9.7 ↖
	Series 84 (0x) 345 (3x)		Series 92 (0x) 437 (3x)

	51: 9.3 ↗ 52: 9.3 → 53: 8.6 ↗ 54: 8.2 ↗ 55: 9.1 → 56: 8.8 ↓ 57: 10.5x ← 58: 10.1 ↓ 59: 8.2 ← 60: 8.8 ↓	
	Series 87 (1x) 524 (4x)	

Comment	Signature		
---------	-----------	--	--

<p>Sight</p>	<table border="1" style="width:100%; border-collapse: collapse;"> <tr><td>1:</td><td>8.8</td><td>←</td></tr> <tr><td>2:</td><td>8.2</td><td>↗</td></tr> <tr><td>3:</td><td>10.6x</td><td>←</td></tr> <tr><td>4:</td><td>10.5x</td><td>↘</td></tr> <tr><td>5:</td><td>9.4</td><td>←</td></tr> <tr><td>6:</td><td>8.4</td><td>↗</td></tr> <tr><td>7:</td><td>7.9</td><td>↗</td></tr> <tr><td>8:</td><td>8.9</td><td>↓</td></tr> <tr><td>9:</td><td>10.0</td><td>↓</td></tr> <tr><td>10:</td><td>10.1</td><td>→</td></tr> <tr><td colspan="2">Series</td><td>88 (2x)</td></tr> <tr><td colspan="2"></td><td>0 (0x)</td></tr> </table>	1:	8.8	←	2:	8.2	↗	3:	10.6x	←	4:	10.5x	↘	5:	9.4	←	6:	8.4	↗	7:	7.9	↗	8:	8.9	↓	9:	10.0	↓	10:	10.1	→	Series		88 (2x)			0 (0x)	<p>Sight</p>	<table border="1" style="width:100%; border-collapse: collapse;"> <tr><td>11:</td><td>8.0</td><td>↘</td></tr> <tr><td>12:</td><td>9.3</td><td>↖</td></tr> <tr><td>13:</td><td>7.3</td><td>↗</td></tr> <tr><td colspan="2">Series</td><td>24 (0x)</td></tr> <tr><td colspan="2"></td><td>0 (0x)</td></tr> </table>	11:	8.0	↘	12:	9.3	↖	13:	7.3	↗	Series		24 (0x)			0 (0x)																					
1:	8.8	←																																																																									
2:	8.2	↗																																																																									
3:	10.6x	←																																																																									
4:	10.5x	↘																																																																									
5:	9.4	←																																																																									
6:	8.4	↗																																																																									
7:	7.9	↗																																																																									
8:	8.9	↓																																																																									
9:	10.0	↓																																																																									
10:	10.1	→																																																																									
Series		88 (2x)																																																																									
		0 (0x)																																																																									
11:	8.0	↘																																																																									
12:	9.3	↖																																																																									
13:	7.3	↗																																																																									
Series		24 (0x)																																																																									
		0 (0x)																																																																									
<p>60 Shots</p>	<table border="1" style="width:100%; border-collapse: collapse;"> <tr><td>1:</td><td>9.2</td><td>↗</td></tr> <tr><td>2:</td><td>9.4</td><td>↓</td></tr> <tr><td>3:</td><td>7.7</td><td>↘</td></tr> <tr><td>4:</td><td>8.8</td><td>↗</td></tr> <tr><td>5:</td><td>9.4</td><td>↗</td></tr> <tr><td>6:</td><td>8.2</td><td>←</td></tr> <tr><td>7:</td><td>8.8</td><td>↗</td></tr> <tr><td>8:</td><td>8.6</td><td>↗</td></tr> <tr><td>9:</td><td>9.6</td><td>↓</td></tr> <tr><td>10:</td><td>10.3</td><td>→</td></tr> <tr><td colspan="2">Series</td><td>85 (0x)</td></tr> <tr><td colspan="2"></td><td>85 (0x)</td></tr> </table>	1:	9.2	↗	2:	9.4	↓	3:	7.7	↘	4:	8.8	↗	5:	9.4	↗	6:	8.2	←	7:	8.8	↗	8:	8.6	↗	9:	9.6	↓	10:	10.3	→	Series		85 (0x)			85 (0x)	<p>60 Shots</p>	<table border="1" style="width:100%; border-collapse: collapse;"> <tr><td>11:</td><td>9.2</td><td>↗</td></tr> <tr><td>12:</td><td>10.2</td><td>↖</td></tr> <tr><td>13:</td><td>10.1</td><td>←</td></tr> <tr><td>14:</td><td>7.8</td><td>↖</td></tr> <tr><td>15:</td><td>7.9</td><td>↘</td></tr> <tr><td>16:</td><td>9.1</td><td>↗</td></tr> <tr><td>17:</td><td>10.2</td><td>→</td></tr> <tr><td>18:</td><td>8.5</td><td>←</td></tr> <tr><td>19:</td><td>9.6</td><td>↗</td></tr> <tr><td>20:</td><td>8.9</td><td>←</td></tr> <tr><td colspan="2">Series</td><td>87 (0x)</td></tr> <tr><td colspan="2"></td><td>172 (0x)</td></tr> </table>	11:	9.2	↗	12:	10.2	↖	13:	10.1	←	14:	7.8	↖	15:	7.9	↘	16:	9.1	↗	17:	10.2	→	18:	8.5	←	19:	9.6	↗	20:	8.9	←	Series		87 (0x)			172 (0x)
1:	9.2	↗																																																																									
2:	9.4	↓																																																																									
3:	7.7	↘																																																																									
4:	8.8	↗																																																																									
5:	9.4	↗																																																																									
6:	8.2	←																																																																									
7:	8.8	↗																																																																									
8:	8.6	↗																																																																									
9:	9.6	↓																																																																									
10:	10.3	→																																																																									
Series		85 (0x)																																																																									
		85 (0x)																																																																									
11:	9.2	↗																																																																									
12:	10.2	↖																																																																									
13:	10.1	←																																																																									
14:	7.8	↖																																																																									
15:	7.9	↘																																																																									
16:	9.1	↗																																																																									
17:	10.2	→																																																																									
18:	8.5	←																																																																									
19:	9.6	↗																																																																									
20:	8.9	←																																																																									
Series		87 (0x)																																																																									
		172 (0x)																																																																									
<p>60 Shots</p>	<table border="1" style="width:100%; border-collapse: collapse;"> <tr><td>21:</td><td>8.5</td><td>↖</td></tr> <tr><td>22:</td><td>8.0</td><td>↘</td></tr> <tr><td>23:</td><td>10.1</td><td>←</td></tr> <tr><td>24:</td><td>9.1</td><td>↓</td></tr> <tr><td>25:</td><td>8.6</td><td>→</td></tr> <tr><td>26:</td><td>8.3</td><td>↗</td></tr> <tr><td>27:</td><td>9.0</td><td>→</td></tr> <tr><td>28:</td><td>9.8</td><td>←</td></tr> <tr><td>29:</td><td>9.6</td><td>→</td></tr> <tr><td>30:</td><td>8.9</td><td>↓</td></tr> <tr><td colspan="2">Series</td><td>86 (0x)</td></tr> <tr><td colspan="2"></td><td>258 (0x)</td></tr> </table>	21:	8.5	↖	22:	8.0	↘	23:	10.1	←	24:	9.1	↓	25:	8.6	→	26:	8.3	↗	27:	9.0	→	28:	9.8	←	29:	9.6	→	30:	8.9	↓	Series		86 (0x)			258 (0x)	<p>60 Shots</p>	<table border="1" style="width:100%; border-collapse: collapse;"> <tr><td>31:</td><td>9.9</td><td>↗</td></tr> <tr><td>32:</td><td>9.3</td><td>→</td></tr> <tr><td>33:</td><td>9.2</td><td>↗</td></tr> <tr><td>34:</td><td>8.7</td><td>→</td></tr> <tr><td>35:</td><td>10.2</td><td>↗</td></tr> <tr><td>36:</td><td>8.8</td><td>↗</td></tr> <tr><td>37:</td><td>9.7</td><td>←</td></tr> <tr><td>38:</td><td>9.7</td><td>↗</td></tr> <tr><td>39:</td><td>9.3</td><td>→</td></tr> <tr><td>40:</td><td>8.4</td><td>↗</td></tr> <tr><td colspan="2">Series</td><td>88 (0x)</td></tr> <tr><td colspan="2"></td><td>346 (0x)</td></tr> </table>	31:	9.9	↗	32:	9.3	→	33:	9.2	↗	34:	8.7	→	35:	10.2	↗	36:	8.8	↗	37:	9.7	←	38:	9.7	↗	39:	9.3	→	40:	8.4	↗	Series		88 (0x)			346 (0x)
21:	8.5	↖																																																																									
22:	8.0	↘																																																																									
23:	10.1	←																																																																									
24:	9.1	↓																																																																									
25:	8.6	→																																																																									
26:	8.3	↗																																																																									
27:	9.0	→																																																																									
28:	9.8	←																																																																									
29:	9.6	→																																																																									
30:	8.9	↓																																																																									
Series		86 (0x)																																																																									
		258 (0x)																																																																									
31:	9.9	↗																																																																									
32:	9.3	→																																																																									
33:	9.2	↗																																																																									
34:	8.7	→																																																																									
35:	10.2	↗																																																																									
36:	8.8	↗																																																																									
37:	9.7	←																																																																									
38:	9.7	↗																																																																									
39:	9.3	→																																																																									
40:	8.4	↗																																																																									
Series		88 (0x)																																																																									
		346 (0x)																																																																									
<p>60 Shots</p>	<table border="1" style="width:100%; border-collapse: collapse;"> <tr><td>41:</td><td>5.5</td><td>→</td></tr> <tr><td>42:</td><td>8.2</td><td>←</td></tr> <tr><td>43:</td><td>10.5x</td><td>←</td></tr> <tr><td>44:</td><td>7.5</td><td>↗</td></tr> <tr><td>45:</td><td>7.5</td><td>←</td></tr> <tr><td>46:</td><td>9.7</td><td>↖</td></tr> <tr><td>47:</td><td>8.2</td><td>↗</td></tr> <tr><td>48:</td><td>9.3</td><td>←</td></tr> <tr><td>49:</td><td>6.8</td><td>→</td></tr> <tr><td>50:</td><td>9.5</td><td>↗</td></tr> <tr><td colspan="2">Series</td><td>78 (1x)</td></tr> <tr><td colspan="2"></td><td>424 (1x)</td></tr> </table>	41:	5.5	→	42:	8.2	←	43:	10.5x	←	44:	7.5	↗	45:	7.5	←	46:	9.7	↖	47:	8.2	↗	48:	9.3	←	49:	6.8	→	50:	9.5	↗	Series		78 (1x)			424 (1x)	<p>60 Shots</p>	<table border="1" style="width:100%; border-collapse: collapse;"> <tr><td>51:</td><td>10.6x</td><td>→</td></tr> <tr><td>52:</td><td>8.4</td><td>←</td></tr> <tr><td>53:</td><td>7.9</td><td>↖</td></tr> <tr><td>54:</td><td>10.3</td><td>↗</td></tr> <tr><td>55:</td><td>9.8</td><td>←</td></tr> <tr><td>56:</td><td>6.8</td><td>←</td></tr> <tr><td>57:</td><td>8.8</td><td>→</td></tr> <tr><td>58:</td><td>9.6</td><td>↗</td></tr> <tr><td>59:</td><td>8.0</td><td>→</td></tr> <tr><td>60:</td><td>5.7</td><td>↘</td></tr> <tr><td colspan="2">Series</td><td>80 (1x)</td></tr> <tr><td colspan="2"></td><td>504 (2x)</td></tr> </table>	51:	10.6x	→	52:	8.4	←	53:	7.9	↖	54:	10.3	↗	55:	9.8	←	56:	6.8	←	57:	8.8	→	58:	9.6	↗	59:	8.0	→	60:	5.7	↘	Series		80 (1x)			504 (2x)
41:	5.5	→																																																																									
42:	8.2	←																																																																									
43:	10.5x	←																																																																									
44:	7.5	↗																																																																									
45:	7.5	←																																																																									
46:	9.7	↖																																																																									
47:	8.2	↗																																																																									
48:	9.3	←																																																																									
49:	6.8	→																																																																									
50:	9.5	↗																																																																									
Series		78 (1x)																																																																									
		424 (1x)																																																																									
51:	10.6x	→																																																																									
52:	8.4	←																																																																									
53:	7.9	↖																																																																									
54:	10.3	↗																																																																									
55:	9.8	←																																																																									
56:	6.8	←																																																																									
57:	8.8	→																																																																									
58:	9.6	↗																																																																									
59:	8.0	→																																																																									
60:	5.7	↘																																																																									
Series		80 (1x)																																																																									
		504 (2x)																																																																									

Relay **1** Lane **17** **PADDA Davinderjit (dave)**

2023 SFC Pistol Nationals BC EX MP

16.07.2023 23PN-AP-Q2 Alberta Handgun Association

Comment Signature

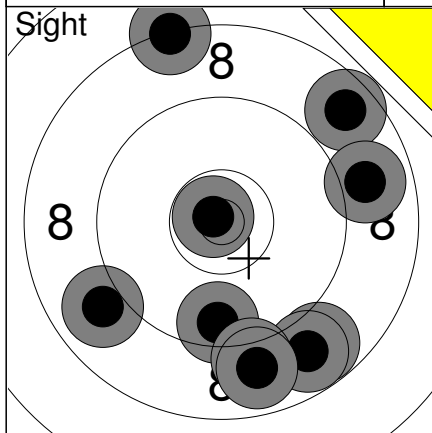

1:	8.3	↑
2:	8.8	↓
3:	8.9	←
4:	10.8x	←
5:	8.7	↗
6:	8.9	→
7:	9.6	↓
8:	8.8	↓
9:	9.0	↓
10:	8.9	↓
Series	84 (1x)	
	0 (0x)	

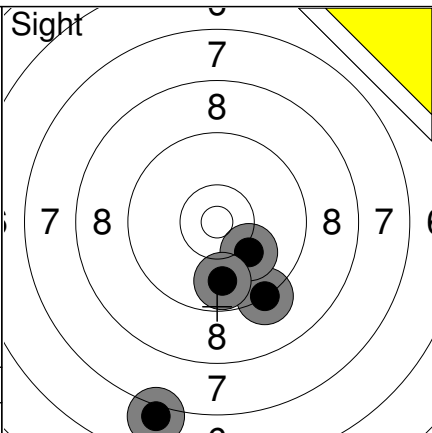

11:	9.3	↓
12:	10.1	↓
13:	9.8	↓
14:	7.0	↓
Series	35 (0x)	
	0 (0x)	

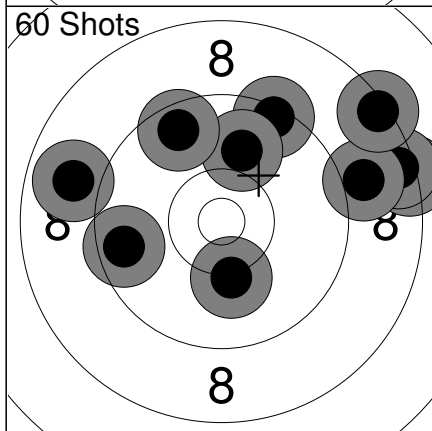

1:	9.6	←
2:	8.9	←
3:	8.3	→
4:	10.2	↓
5:	8.4	→
6:	8.9	→
7:	8.4	↗
8:	9.4	↗
9:	9.9	↑
10:	9.6	↗
Series	86 (0x)	
	86 (0x)	

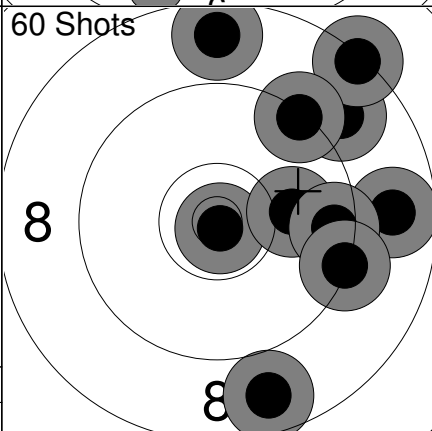

11:	8.6	↑
12:	8.9	↗
13:	10.9x	↓
14:	10.0	→
15:	8.8	→
16:	9.5	→
17:	8.3	↗
18:	9.3	→
19:	8.7	↓
20:	9.3	↗
Series	87 (1x)	
	173 (1x)	

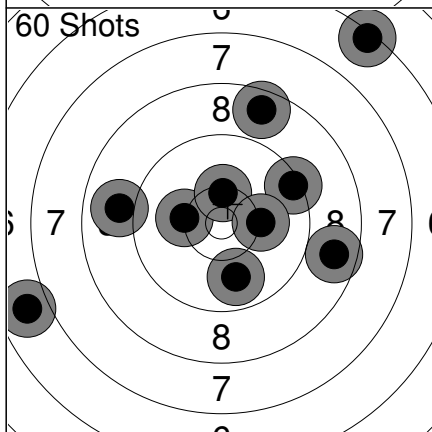

21:	6.8	←
22:	8.6	↑
23:	10.2	←
24:	9.4	↗
25:	8.9	←
26:	9.9	↓
27:	6.4	↗
28:	10.4x	↑
29:	8.7	→
30:	10.2	→
Series	84 (1x)	
	257 (2x)	

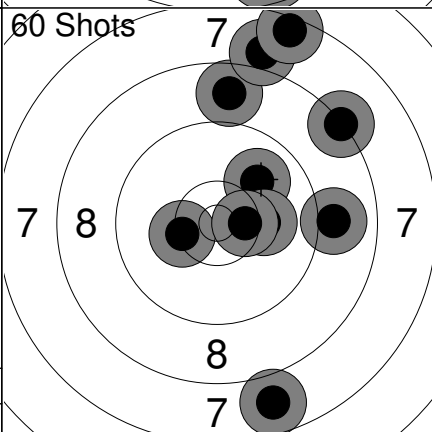

31:	8.7	↑
32:	10.0	↗
33:	9.0	→
34:	10.1	→
35:	10.3	←
36:	8.0	↑
37:	7.8	↓
38:	10.5x	→
39:	7.5	↑
40:	8.3	↗
Series	87 (1x)	
	344 (3x)	

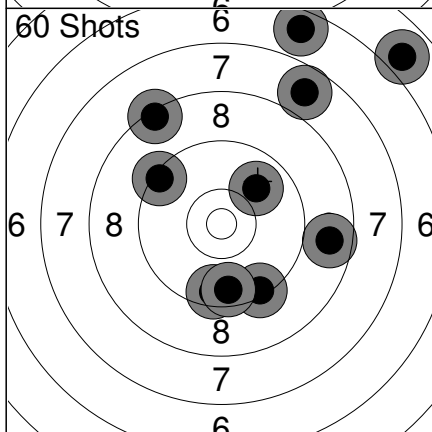

41:	5.9	↗
42:	8.4	↗
43:	8.7	→
44:	9.4	↓
45:	9.5	↓
46:	6.6	↑
47:	9.9	↗
48:	7.7	↗
49:	9.4	←
50:	9.6	↓
Series	79 (0x)	
	423 (3x)	

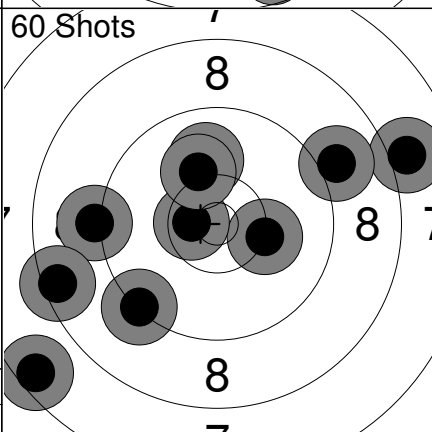

51:	10.2	→
52:	7.5	↙
53:	10.0	↑
54:	10.6x	←
55:	8.0	→
56:	9.1	←
57:	10.1	↑
58:	9.0	↗
59:	9.3	↙
60:	8.4	←
Series	90 (1x)	
	513 (4x)	

Relay <b>1</b>	Lane <b>18</b>	<b>BURNS Stuart</b>
-------------------	-------------------	---------------------

2023 SFC Pistol Nationals	ON	EX	MP
---------------------------	----	----	----

16.07.2023	23PN-AP-Q2	Alberta Handgun Association
------------	------------	-----------------------------

Comment	Signature
---------	-----------

<p>Sight</p>	<p>1: 9.8 ↙ 2: 6.3 ↑ 3: 7.9 ← 4: 10.6x ↑ 5: 7.8 ← 6: 10.4 ↑ 7: 10.5x ↑ 8: 9.7 ← 9: 10.3 ← 10: 9.7 ↗</p> <p>Series 87 (2x) 0 (0x)</p>	<p>Sight</p>	<p>11: 10.0 ↑ 12: 9.7 → 13: 9.4 ↗</p> <p>Series 28 (0x) 0 (0x)</p>
<p>60 Shots</p>	<p>1: 10.7x ↙ 2: 9.8 ← 3: 9.2 ← 4: 9.2 ← 5: 10.1 ↑ 6: 8.7 ← 7: 9.9 ← 8: 9.5 ↑ 9: 9.6 ↑ 10: 9.8 ←</p> <p>Series 91 (1x) 91 (1x)</p>	<p>60 Shots</p>	<p>11: 9.4 ↗ 12: 9.9 → 13: 9.9 ↖ 14: 9.1 ↗ 15: 10.1 ↗ 16: 10.3 ↖ 17: 10.6x ↑ 18: 9.6 ↖ 19: 8.6 ↗ 20: 10.0 ↓</p> <p>Series 93 (1x) 184 (2x)</p>
<p>60 Shots</p>	<p>21: 9.8 ↑ 22: 8.8 ↑ 23: 9.7 → 24: 9.7 ← 25: 10.6x ← 26: 10.3 ← 27: 10.4 → 28: 8.6 ← 29: 9.5 ↑ 30: 8.8 ↙</p> <p>Series 90 (1x) 274 (3x)</p>	<p>60 Shots</p>	<p>31: 8.4 ← 32: 8.5 ↑ 33: 9.6 ↑ 34: 10.5x ↖ 35: 9.5 → 36: 10.4x → 37: 7.4 ↑ 38: 8.4 ↖ 39: 10.8x ↑ 40: 10.5x ↗</p> <p>Series 89 (4x) 363 (7x)</p>
<p>60 Shots</p>	<p>41: 10.6x ↑ 42: 10.5x ↓ 43: 9.8 ↗ 44: 9.6 ↗ 45: 9.5 ↑ 46: 9.2 ← 47: 10.3 ← 48: 9.2 ↑ 49: 8.5 ← 50: 10.2 ↗</p> <p>Series 93 (2x) 456 (9x)</p>	<p>60 Shots</p>	<p>51: 9.5 ↗ 52: 9.5 ↑ 53: 9.7 ← 54: 9.6 → 55: 9.9 ↖ 56: 10.0 ↗ 57: 9.4 ↓ 58: 9.3 ↗ 59: 10.5x ↓ 60: 10.6x ↘</p> <p>Series 93 (2x) 549 (11x)</p>

Comment	Signature
---------	-----------

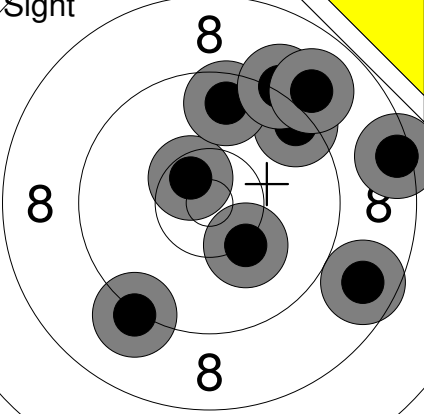
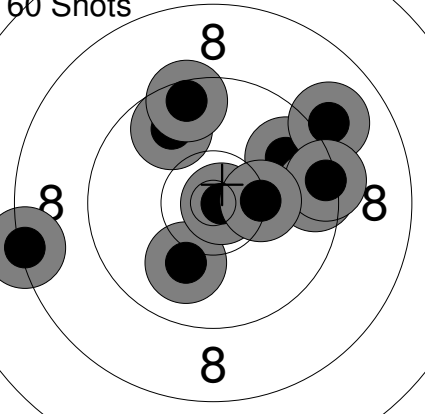
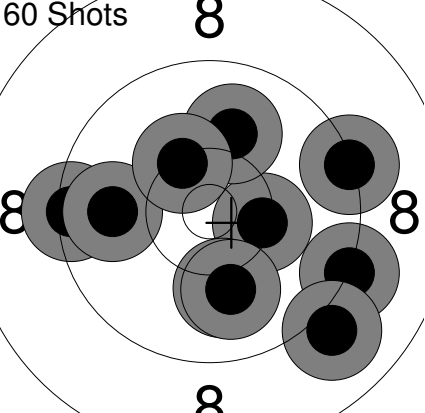
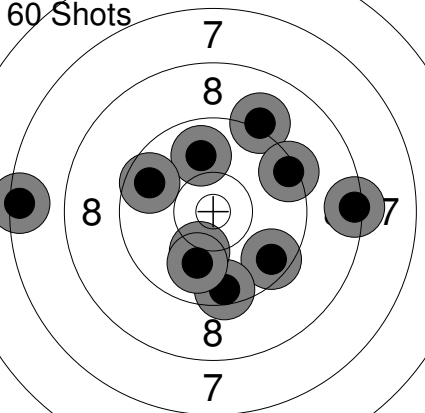
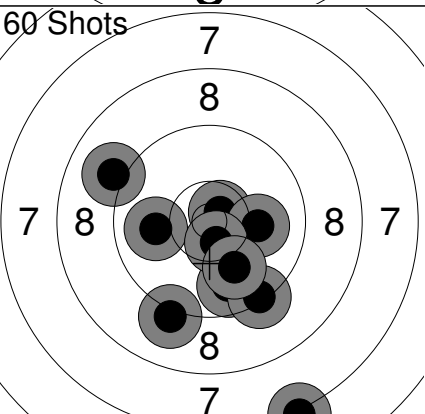
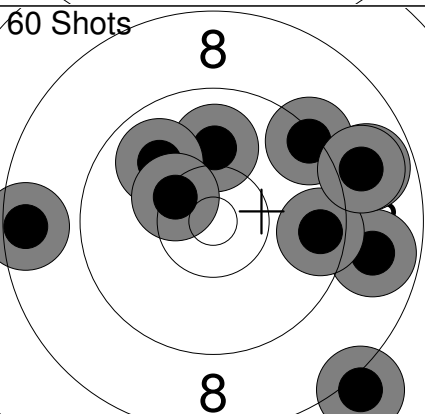
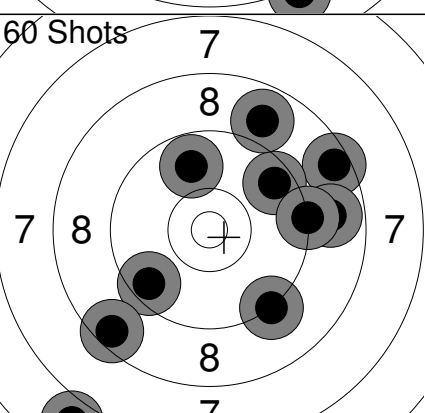
<b>Sight</b> 	<table border="1" style="width:100%; border-collapse: collapse;"> <tr><td>1: 10.5x ↗</td></tr> <tr><td>2: 10.2 ↘</td></tr> <tr><td>3: 9.4 ↗</td></tr> <tr><td>4: 8.4 →</td></tr> <tr><td>5: 9.6 ↑</td></tr> <tr><td>6: 9.2 ↘</td></tr> <tr><td>7: 8.7 ↘</td></tr> <tr><td>8: 9.2 ↗</td></tr> <tr><td>9: 9.0 ↗</td></tr> <tr><td><b>Series</b> 81 (1x)</td></tr> <tr><td>0 (0x)</td></tr> </table>	1: 10.5x ↗	2: 10.2 ↘	3: 9.4 ↗	4: 8.4 →	5: 9.6 ↑	6: 9.2 ↘	7: 8.7 ↘	8: 9.2 ↗	9: 9.0 ↗	<b>Series</b> 81 (1x)	0 (0x)	<b>60 Shots</b> 	<table border="1" style="width:100%; border-collapse: collapse;"> <tr><td>1: 10.0 ↘</td></tr> <tr><td>2: 9.8 ↗</td></tr> <tr><td>3: 10.8x →</td></tr> <tr><td>4: 9.5 →</td></tr> <tr><td>5: 9.0 ↗</td></tr> <tr><td>6: 9.8 ↗</td></tr> <tr><td>7: 9.4 →</td></tr> <tr><td>8: 10.3 →</td></tr> <tr><td>9: 8.3 ←</td></tr> <tr><td>10: 9.5 ↑</td></tr> <tr><td><b>Series</b> 92 (1x)</td></tr> <tr><td>92 (1x)</td></tr> </table>	1: 10.0 ↘	2: 9.8 ↗	3: 10.8x →	4: 9.5 →	5: 9.0 ↗	6: 9.8 ↗	7: 9.4 →	8: 10.3 →	9: 8.3 ←	10: 9.5 ↑	<b>Series</b> 92 (1x)	92 (1x)	
1: 10.5x ↗																											
2: 10.2 ↘																											
3: 9.4 ↗																											
4: 8.4 →																											
5: 9.6 ↑																											
6: 9.2 ↘																											
7: 8.7 ↘																											
8: 9.2 ↗																											
9: 9.0 ↗																											
<b>Series</b> 81 (1x)																											
0 (0x)																											
1: 10.0 ↘																											
2: 9.8 ↗																											
3: 10.8x →																											
4: 9.5 →																											
5: 9.0 ↗																											
6: 9.8 ↗																											
7: 9.4 →																											
8: 10.3 →																											
9: 8.3 ←																											
10: 9.5 ↑																											
<b>Series</b> 92 (1x)																											
92 (1x)																											
<b>60 Shots</b> 	<table border="1" style="width:100%; border-collapse: collapse;"> <tr><td>11: 9.4 ←</td></tr> <tr><td>12: 9.2 →</td></tr> <tr><td>13: 10.3 →</td></tr> <tr><td>14: 10.1 ↘</td></tr> <tr><td>15: 10.0 ↘</td></tr> <tr><td>16: 9.3 →</td></tr> <tr><td>17: 10.0 ↑</td></tr> <tr><td>18: 9.0 ↘</td></tr> <tr><td>19: 9.8 ←</td></tr> <tr><td>20: 10.3 ↗</td></tr> <tr><td><b>Series</b> 95 (0x)</td></tr> <tr><td>187 (1x)</td></tr> </table>	11: 9.4 ←	12: 9.2 →	13: 10.3 →	14: 10.1 ↘	15: 10.0 ↘	16: 9.3 →	17: 10.0 ↑	18: 9.0 ↘	19: 9.8 ←	20: 10.3 ↗	<b>Series</b> 95 (0x)	187 (1x)	<b>60 Shots</b> 	<table border="1" style="width:100%; border-collapse: collapse;"> <tr><td>21: 9.9 ↑</td></tr> <tr><td>22: 9.6 ↘</td></tr> <tr><td>23: 9.5 ↘</td></tr> <tr><td>24: 9.1 ↗</td></tr> <tr><td>25: 8.4 →</td></tr> <tr><td>26: 10.2 ↘</td></tr> <tr><td>27: 9.7 ↖</td></tr> <tr><td>28: 9.4 ↗</td></tr> <tr><td>29: 7.4 ←</td></tr> <tr><td>30: 10.0 ↘</td></tr> <tr><td><b>Series</b> 89 (0x)</td></tr> <tr><td>276 (1x)</td></tr> </table>	21: 9.9 ↑	22: 9.6 ↘	23: 9.5 ↘	24: 9.1 ↗	25: 8.4 →	26: 10.2 ↘	27: 9.7 ↖	28: 9.4 ↗	29: 7.4 ←	30: 10.0 ↘	<b>Series</b> 89 (0x)	276 (1x)
11: 9.4 ←																											
12: 9.2 →																											
13: 10.3 →																											
14: 10.1 ↘																											
15: 10.0 ↘																											
16: 9.3 →																											
17: 10.0 ↑																											
18: 9.0 ↘																											
19: 9.8 ←																											
20: 10.3 ↗																											
<b>Series</b> 95 (0x)																											
187 (1x)																											
21: 9.9 ↑																											
22: 9.6 ↘																											
23: 9.5 ↘																											
24: 9.1 ↗																											
25: 8.4 →																											
26: 10.2 ↘																											
27: 9.7 ↖																											
28: 9.4 ↗																											
29: 7.4 ←																											
30: 10.0 ↘																											
<b>Series</b> 89 (0x)																											
276 (1x)																											
<b>60 Shots</b> 	<table border="1" style="width:100%; border-collapse: collapse;"> <tr><td>31: 9.8 ↘</td></tr> <tr><td>32: 9.3 ↘</td></tr> <tr><td>33: 10.7x ↗</td></tr> <tr><td>34: 7.1 ↘</td></tr> <tr><td>35: 9.0 ↗</td></tr> <tr><td>36: 10.1 →</td></tr> <tr><td>37: 10.0 ←</td></tr> <tr><td>38: 10.5x ↘</td></tr> <tr><td>39: 10.0 ↘</td></tr> <tr><td>40: 9.1 ↘</td></tr> <tr><td><b>Series</b> 93 (2x)</td></tr> <tr><td>369 (3x)</td></tr> </table>	31: 9.8 ↘	32: 9.3 ↘	33: 10.7x ↗	34: 7.1 ↘	35: 9.0 ↗	36: 10.1 →	37: 10.0 ←	38: 10.5x ↘	39: 10.0 ↘	40: 9.1 ↘	<b>Series</b> 93 (2x)	369 (3x)	<b>60 Shots</b> 	<table border="1" style="width:100%; border-collapse: collapse;"> <tr><td>41: 8.8 →</td></tr> <tr><td>42: 8.8 →</td></tr> <tr><td>43: 9.3 ↗</td></tr> <tr><td>44: 8.5 ←</td></tr> <tr><td>45: 8.1 ↘</td></tr> <tr><td>46: 10.0 ↑</td></tr> <tr><td>47: 9.9 ↗</td></tr> <tr><td>48: 9.6 →</td></tr> <tr><td>49: 10.4x ↖</td></tr> <tr><td>50: 8.9 →</td></tr> <tr><td><b>Series</b> 87 (1x)</td></tr> <tr><td>456 (4x)</td></tr> </table>	41: 8.8 →	42: 8.8 →	43: 9.3 ↗	44: 8.5 ←	45: 8.1 ↘	46: 10.0 ↑	47: 9.9 ↗	48: 9.6 →	49: 10.4x ↖	50: 8.9 →	<b>Series</b> 87 (1x)	456 (4x)
31: 9.8 ↘																											
32: 9.3 ↘																											
33: 10.7x ↗																											
34: 7.1 ↘																											
35: 9.0 ↗																											
36: 10.1 →																											
37: 10.0 ←																											
38: 10.5x ↘																											
39: 10.0 ↘																											
40: 9.1 ↘																											
<b>Series</b> 93 (2x)																											
369 (3x)																											
41: 8.8 →																											
42: 8.8 →																											
43: 9.3 ↗																											
44: 8.5 ←																											
45: 8.1 ↘																											
46: 10.0 ↑																											
47: 9.9 ↗																											
48: 9.6 →																											
49: 10.4x ↖																											
50: 8.9 →																											
<b>Series</b> 87 (1x)																											
456 (4x)																											
<b>60 Shots</b> 	<table border="1" style="width:100%; border-collapse: collapse;"> <tr><td>51: 8.5 →</td></tr> <tr><td>52: 8.8 →</td></tr> <tr><td>53: 9.6 ↗</td></tr> <tr><td>54: 8.9 ↗</td></tr> <tr><td>55: 6.8 ↘</td></tr> <tr><td>56: 9.2 →</td></tr> <tr><td>57: 9.5 ↘</td></tr> <tr><td>58: 9.2 ↘</td></tr> <tr><td>59: 9.8 ↗</td></tr> <tr><td>60: 8.5 ↘</td></tr> <tr><td><b>Series</b> 83 (0x)</td></tr> <tr><td>539 (4x)</td></tr> </table>	51: 8.5 →	52: 8.8 →	53: 9.6 ↗	54: 8.9 ↗	55: 6.8 ↘	56: 9.2 →	57: 9.5 ↘	58: 9.2 ↘	59: 9.8 ↗	60: 8.5 ↘	<b>Series</b> 83 (0x)	539 (4x)														
51: 8.5 →																											
52: 8.8 →																											
53: 9.6 ↗																											
54: 8.9 ↗																											
55: 6.8 ↘																											
56: 9.2 →																											
57: 9.5 ↘																											
58: 9.2 ↘																											
59: 9.8 ↗																											
60: 8.5 ↘																											
<b>Series</b> 83 (0x)																											
539 (4x)																											



<b>Relay</b> 1	<b>Lane</b> 21	<b>EK Nils</b>
-------------------	-------------------	----------------

2023 SFC Pistol Nationals	QC	EX	MP
---------------------------	----	----	----

16.07.2023	23PN-AP-Q2	Alberta Handgun Association
------------	------------	-----------------------------

Comment	Signature
---------	-----------

<p><b>Sight</b></p>	<table border="1" style="width:100%; border-collapse: collapse;"> <tr><td>1:</td><td>8.9</td><td>↑</td></tr> <tr><td>2:</td><td>6.0</td><td>←</td></tr> <tr><td>3:</td><td>8.3</td><td>↗</td></tr> <tr><td>4:</td><td>9.4</td><td>←</td></tr> <tr><td>5:</td><td>9.0</td><td>↙</td></tr> <tr><td>6:</td><td>8.7</td><td>↘</td></tr> <tr><td>7:</td><td>9.5</td><td>↗</td></tr> <tr><td>8:</td><td>9.2</td><td>↗</td></tr> <tr><td>9:</td><td>6.4</td><td>←</td></tr> <tr><td>10:</td><td>8.3</td><td>→</td></tr> <tr><td colspan="2"><b>Series</b></td><td>80 (0x)</td></tr> <tr><td colspan="2"></td><td>0 (0x)</td></tr> </table>	1:	8.9	↑	2:	6.0	←	3:	8.3	↗	4:	9.4	←	5:	9.0	↙	6:	8.7	↘	7:	9.5	↗	8:	9.2	↗	9:	6.4	←	10:	8.3	→	<b>Series</b>		80 (0x)			0 (0x)	<p><b>Sight</b></p>	<table border="1" style="width:100%; border-collapse: collapse;"> <tr><td>11:</td><td>8.8</td><td>→</td></tr> <tr><td>12:</td><td>8.7</td><td>↗</td></tr> <tr><td>13:</td><td>6.3</td><td>→</td></tr> <tr><td>14:</td><td>10.6x</td><td>↗</td></tr> <tr><td>15:</td><td>8.6</td><td>↘</td></tr> <tr><td colspan="2"><b>Series</b></td><td>40 (1x)</td></tr> <tr><td colspan="2"></td><td>0 (0x)</td></tr> </table>	11:	8.8	→	12:	8.7	↗	13:	6.3	→	14:	10.6x	↗	15:	8.6	↘	<b>Series</b>		40 (1x)			0 (0x)															
1:	8.9	↑																																																																									
2:	6.0	←																																																																									
3:	8.3	↗																																																																									
4:	9.4	←																																																																									
5:	9.0	↙																																																																									
6:	8.7	↘																																																																									
7:	9.5	↗																																																																									
8:	9.2	↗																																																																									
9:	6.4	←																																																																									
10:	8.3	→																																																																									
<b>Series</b>		80 (0x)																																																																									
		0 (0x)																																																																									
11:	8.8	→																																																																									
12:	8.7	↗																																																																									
13:	6.3	→																																																																									
14:	10.6x	↗																																																																									
15:	8.6	↘																																																																									
<b>Series</b>		40 (1x)																																																																									
		0 (0x)																																																																									
<p><b>60 Shots</b></p>	<table border="1" style="width:100%; border-collapse: collapse;"> <tr><td>1:</td><td>7.4</td><td>→</td></tr> <tr><td>2:</td><td>9.3</td><td>↗</td></tr> <tr><td>3:</td><td>10.0</td><td>↑</td></tr> <tr><td>4:</td><td>6.6</td><td>→</td></tr> <tr><td>5:</td><td>10.1</td><td>↗</td></tr> <tr><td>6:</td><td>9.4</td><td>←</td></tr> <tr><td>7:</td><td>9.0</td><td>↑</td></tr> <tr><td>8:</td><td>8.2</td><td>→</td></tr> <tr><td>9:</td><td>9.5</td><td>→</td></tr> <tr><td>10:</td><td>9.1</td><td>↘</td></tr> <tr><td colspan="2"><b>Series</b></td><td>86 (0x)</td></tr> <tr><td colspan="2"></td><td>86 (0x)</td></tr> </table>	1:	7.4	→	2:	9.3	↗	3:	10.0	↑	4:	6.6	→	5:	10.1	↗	6:	9.4	←	7:	9.0	↑	8:	8.2	→	9:	9.5	→	10:	9.1	↘	<b>Series</b>		86 (0x)			86 (0x)	<p><b>60 Shots</b></p>	<table border="1" style="width:100%; border-collapse: collapse;"> <tr><td>11:</td><td>8.5</td><td>←</td></tr> <tr><td>12:</td><td>8.1</td><td>↗</td></tr> <tr><td>13:</td><td>9.3</td><td>↘</td></tr> <tr><td>14:</td><td>9.1</td><td>→</td></tr> <tr><td>15:</td><td>5.6</td><td>↘</td></tr> <tr><td>16:</td><td>9.5</td><td>↘</td></tr> <tr><td>17:</td><td>8.7</td><td>↙</td></tr> <tr><td>18:</td><td>9.8</td><td>→</td></tr> <tr><td>19:</td><td>9.0</td><td>→</td></tr> <tr><td>20:</td><td>10.1</td><td>↘</td></tr> <tr><td colspan="2"><b>Series</b></td><td>84 (0x)</td></tr> <tr><td colspan="2"></td><td>170 (0x)</td></tr> </table>	11:	8.5	←	12:	8.1	↗	13:	9.3	↘	14:	9.1	→	15:	5.6	↘	16:	9.5	↘	17:	8.7	↙	18:	9.8	→	19:	9.0	→	20:	10.1	↘	<b>Series</b>		84 (0x)			170 (0x)
1:	7.4	→																																																																									
2:	9.3	↗																																																																									
3:	10.0	↑																																																																									
4:	6.6	→																																																																									
5:	10.1	↗																																																																									
6:	9.4	←																																																																									
7:	9.0	↑																																																																									
8:	8.2	→																																																																									
9:	9.5	→																																																																									
10:	9.1	↘																																																																									
<b>Series</b>		86 (0x)																																																																									
		86 (0x)																																																																									
11:	8.5	←																																																																									
12:	8.1	↗																																																																									
13:	9.3	↘																																																																									
14:	9.1	→																																																																									
15:	5.6	↘																																																																									
16:	9.5	↘																																																																									
17:	8.7	↙																																																																									
18:	9.8	→																																																																									
19:	9.0	→																																																																									
20:	10.1	↘																																																																									
<b>Series</b>		84 (0x)																																																																									
		170 (0x)																																																																									
<p><b>60 Shots</b></p>	<table border="1" style="width:100%; border-collapse: collapse;"> <tr><td>21:</td><td>8.1</td><td>↘</td></tr> <tr><td>22:</td><td>9.3</td><td>→</td></tr> <tr><td>23:</td><td>9.1</td><td>↑</td></tr> <tr><td>24:</td><td>9.7</td><td>↘</td></tr> <tr><td>25:</td><td>8.4</td><td>←</td></tr> <tr><td>26:</td><td>8.5</td><td>↗</td></tr> <tr><td>27:</td><td>9.9</td><td>→</td></tr> <tr><td>28:</td><td>7.4</td><td>↘</td></tr> <tr><td>29:</td><td>8.5</td><td>→</td></tr> <tr><td>30:</td><td>8.3</td><td>→</td></tr> <tr><td colspan="2"><b>Series</b></td><td>83 (0x)</td></tr> <tr><td colspan="2"></td><td>253 (0x)</td></tr> </table>	21:	8.1	↘	22:	9.3	→	23:	9.1	↑	24:	9.7	↘	25:	8.4	←	26:	8.5	↗	27:	9.9	→	28:	7.4	↘	29:	8.5	→	30:	8.3	→	<b>Series</b>		83 (0x)			253 (0x)	<p><b>60 Shots</b></p>	<table border="1" style="width:100%; border-collapse: collapse;"> <tr><td>31:</td><td>10.8x</td><td>↘</td></tr> <tr><td>32:</td><td>8.1</td><td>↘</td></tr> <tr><td>33:</td><td>7.5</td><td>↘</td></tr> <tr><td>34:</td><td>10.7x</td><td>→</td></tr> <tr><td>35:</td><td>8.4</td><td>↑</td></tr> <tr><td>36:</td><td>10.6x</td><td>↘</td></tr> <tr><td>37:</td><td>9.9</td><td>→</td></tr> <tr><td>38:</td><td>8.2</td><td>↑</td></tr> <tr><td>39:</td><td>9.2</td><td>→</td></tr> <tr><td>40:</td><td>8.9</td><td>↗</td></tr> <tr><td colspan="2"><b>Series</b></td><td>87 (3x)</td></tr> <tr><td colspan="2"></td><td>340 (3x)</td></tr> </table>	31:	10.8x	↘	32:	8.1	↘	33:	7.5	↘	34:	10.7x	→	35:	8.4	↑	36:	10.6x	↘	37:	9.9	→	38:	8.2	↑	39:	9.2	→	40:	8.9	↗	<b>Series</b>		87 (3x)			340 (3x)
21:	8.1	↘																																																																									
22:	9.3	→																																																																									
23:	9.1	↑																																																																									
24:	9.7	↘																																																																									
25:	8.4	←																																																																									
26:	8.5	↗																																																																									
27:	9.9	→																																																																									
28:	7.4	↘																																																																									
29:	8.5	→																																																																									
30:	8.3	→																																																																									
<b>Series</b>		83 (0x)																																																																									
		253 (0x)																																																																									
31:	10.8x	↘																																																																									
32:	8.1	↘																																																																									
33:	7.5	↘																																																																									
34:	10.7x	→																																																																									
35:	8.4	↑																																																																									
36:	10.6x	↘																																																																									
37:	9.9	→																																																																									
38:	8.2	↑																																																																									
39:	9.2	→																																																																									
40:	8.9	↗																																																																									
<b>Series</b>		87 (3x)																																																																									
		340 (3x)																																																																									
<p><b>60 Shots</b></p>	<table border="1" style="width:100%; border-collapse: collapse;"> <tr><td>41:</td><td>8.3</td><td>↘</td></tr> <tr><td>42:</td><td>9.1</td><td>↘</td></tr> <tr><td>43:</td><td>9.5</td><td>→</td></tr> <tr><td>44:</td><td>10.5x</td><td>←</td></tr> <tr><td>45:</td><td>8.0</td><td>↘</td></tr> <tr><td>46:</td><td>9.2</td><td>→</td></tr> <tr><td>47:</td><td>8.0</td><td>↑</td></tr> <tr><td>48:</td><td>8.8</td><td>↘</td></tr> <tr><td>49:</td><td>9.6</td><td>↘</td></tr> <tr><td>50:</td><td>9.9</td><td>↗</td></tr> <tr><td colspan="2"><b>Series</b></td><td>87 (1x)</td></tr> <tr><td colspan="2"></td><td>427 (4x)</td></tr> </table>	41:	8.3	↘	42:	9.1	↘	43:	9.5	→	44:	10.5x	←	45:	8.0	↘	46:	9.2	→	47:	8.0	↑	48:	8.8	↘	49:	9.6	↘	50:	9.9	↗	<b>Series</b>		87 (1x)			427 (4x)	<p><b>60 Shots</b></p>	<table border="1" style="width:100%; border-collapse: collapse;"> <tr><td>51:</td><td>9.2</td><td>↖</td></tr> <tr><td>52:</td><td>10.3</td><td>↑</td></tr> <tr><td>53:</td><td>10.1</td><td>←</td></tr> <tr><td>54:</td><td>7.5</td><td>→</td></tr> <tr><td>55:</td><td>10.6x</td><td>↖</td></tr> <tr><td>56:</td><td>8.9</td><td>↗</td></tr> <tr><td>57:</td><td>8.4</td><td>→</td></tr> <tr><td>58:</td><td>9.7</td><td>↗</td></tr> <tr><td>59:</td><td>9.6</td><td>↘</td></tr> <tr><td>60:</td><td>9.0</td><td>←</td></tr> <tr><td colspan="2"><b>Series</b></td><td>89 (1x)</td></tr> <tr><td colspan="2"></td><td>516 (5x)</td></tr> </table>	51:	9.2	↖	52:	10.3	↑	53:	10.1	←	54:	7.5	→	55:	10.6x	↖	56:	8.9	↗	57:	8.4	→	58:	9.7	↗	59:	9.6	↘	60:	9.0	←	<b>Series</b>		89 (1x)			516 (5x)
41:	8.3	↘																																																																									
42:	9.1	↘																																																																									
43:	9.5	→																																																																									
44:	10.5x	←																																																																									
45:	8.0	↘																																																																									
46:	9.2	→																																																																									
47:	8.0	↑																																																																									
48:	8.8	↘																																																																									
49:	9.6	↘																																																																									
50:	9.9	↗																																																																									
<b>Series</b>		87 (1x)																																																																									
		427 (4x)																																																																									
51:	9.2	↖																																																																									
52:	10.3	↑																																																																									
53:	10.1	←																																																																									
54:	7.5	→																																																																									
55:	10.6x	↖																																																																									
56:	8.9	↗																																																																									
57:	8.4	→																																																																									
58:	9.7	↗																																																																									
59:	9.6	↘																																																																									
60:	9.0	←																																																																									
<b>Series</b>		89 (1x)																																																																									
		516 (5x)																																																																									

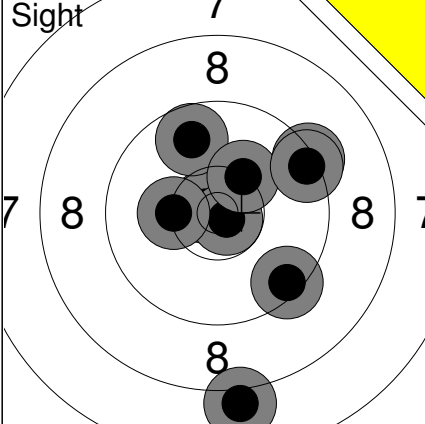
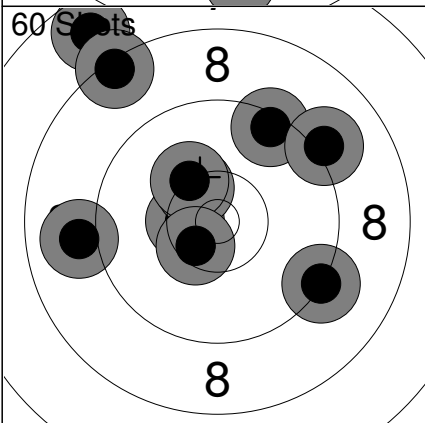
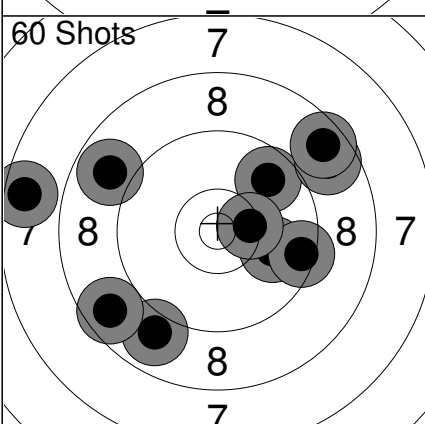
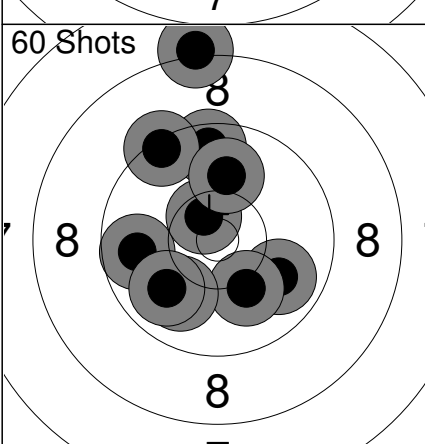
<p>Sight</p> 	<p>60 Shots</p> 	<p>60 Shots</p> 	<p>60 Shots</p> 	<table border="1" style="width:100%; border-collapse: collapse;"> <tr><td>1: 8.0</td><td>↓</td></tr> <tr><td>2: 9.4</td><td>↘</td></tr> <tr><td>3: 10.7x</td><td>↗</td></tr> <tr><td>4: 9.3</td><td>→</td></tr> <tr><td>5: 10.8x</td><td>↘</td></tr> <tr><td>6: 9.8</td><td>↗</td></tr> <tr><td>7: 10.3</td><td>↗</td></tr> <tr><td>8: 9.4</td><td>→</td></tr> <tr><td>9: 10.3</td><td>←</td></tr> <tr><td colspan="2">Series 84 ( 2x)</td></tr> <tr><td colspan="2">0 ( 0x)</td></tr> </table>	1: 8.0	↓	2: 9.4	↘	3: 10.7x	↗	4: 9.3	→	5: 10.8x	↘	6: 9.8	↗	7: 10.3	↗	8: 9.4	→	9: 10.3	←	Series 84 ( 2x)		0 ( 0x)		<table border="1" style="width:100%; border-collapse: collapse;"> <tr><td>1: 8.0</td><td>→</td></tr> <tr><td>2: 10.8x</td><td>←</td></tr> <tr><td>3: 8.9</td><td>→</td></tr> <tr><td>4: 9.6</td><td>↗</td></tr> <tr><td>5: 10.3</td><td>↗</td></tr> <tr><td>6: 9.5</td><td>↑</td></tr> <tr><td>7: 7.4</td><td>↖</td></tr> <tr><td>8: 8.7</td><td>↓</td></tr> <tr><td>9: 9.3</td><td>↗</td></tr> <tr><td>10: 8.8</td><td>↗</td></tr> <tr><td colspan="2">Series 86 ( 1x)</td></tr> <tr><td colspan="2">86 ( 1x)</td></tr> </table>	1: 8.0	→	2: 10.8x	←	3: 8.9	→	4: 9.6	↗	5: 10.3	↗	6: 9.5	↑	7: 7.4	↖	8: 8.7	↓	9: 9.3	↗	10: 8.8	↗	Series 86 ( 1x)		86 ( 1x)		<table border="1" style="width:100%; border-collapse: collapse;"> <tr><td>11: 9.0</td><td>←</td></tr> <tr><td>12: 7.7</td><td>↗</td></tr> <tr><td>13: 9.4</td><td>↗</td></tr> <tr><td>14: 8.4</td><td>↗</td></tr> <tr><td>15: 10.5x</td><td>←</td></tr> <tr><td>16: 9.2</td><td>↘</td></tr> <tr><td>17: 10.4x</td><td>↗</td></tr> <tr><td>18: 9.1</td><td>↗</td></tr> <tr><td>19: 10.3</td><td>↗</td></tr> <tr><td>20: 10.5x</td><td>↘</td></tr> <tr><td colspan="2">Series 91 ( 3x)</td></tr> <tr><td colspan="2">177 ( 4x)</td></tr> </table>	11: 9.0	←	12: 7.7	↗	13: 9.4	↗	14: 8.4	↗	15: 10.5x	←	16: 9.2	↘	17: 10.4x	↗	18: 9.1	↗	19: 10.3	↗	20: 10.5x	↘	Series 91 ( 3x)		177 ( 4x)		<table border="1" style="width:100%; border-collapse: collapse;"> <tr><td>21: 7.7</td><td>↗</td></tr> <tr><td>22: 8.8</td><td>↖</td></tr> <tr><td>23: 8.9</td><td>↓</td></tr> <tr><td>24: 8.7</td><td>←</td></tr> <tr><td>25: 9.5</td><td>↖</td></tr> <tr><td>26: 9.5</td><td>↓</td></tr> <tr><td>27: 9.8</td><td>↗</td></tr> <tr><td>28: 9.6</td><td>↑</td></tr> <tr><td>29: 9.2</td><td>↖</td></tr> <tr><td>30: 10.8x</td><td>←</td></tr> <tr><td colspan="2">Series 86 ( 1x)</td></tr> <tr><td colspan="2">263 ( 5x)</td></tr> </table>	21: 7.7	↗	22: 8.8	↖	23: 8.9	↓	24: 8.7	←	25: 9.5	↖	26: 9.5	↓	27: 9.8	↗	28: 9.6	↑	29: 9.2	↖	30: 10.8x	←	Series 86 ( 1x)		263 ( 5x)		<table border="1" style="width:100%; border-collapse: collapse;"> <tr><td>31: 9.7</td><td>↗</td></tr> <tr><td>32: 9.9</td><td>→</td></tr> <tr><td>33: 7.6</td><td>←</td></tr> <tr><td>34: 8.9</td><td>↘</td></tr> <tr><td>35: 8.8</td><td>↗</td></tr> <tr><td>36: 9.5</td><td>→</td></tr> <tr><td>37: 8.7</td><td>→</td></tr> <tr><td>38: 8.7</td><td>←</td></tr> <tr><td>39: 10.4x</td><td>→</td></tr> <tr><td>40: 8.6</td><td>↗</td></tr> <tr><td colspan="2">Series 84 ( 1x)</td></tr> <tr><td colspan="2">347 ( 6x)</td></tr> </table>	31: 9.7	↗	32: 9.9	→	33: 7.6	←	34: 8.9	↘	35: 8.8	↗	36: 9.5	→	37: 8.7	→	38: 8.7	←	39: 10.4x	→	40: 8.6	↗	Series 84 ( 1x)		347 ( 6x)		<table border="1" style="width:100%; border-collapse: collapse;"> <tr><td>41: 8.6</td><td>↖</td></tr> <tr><td>42: 8.4</td><td>↗</td></tr> <tr><td>43: 7.8</td><td>↖</td></tr> <tr><td>44: 7.0</td><td>←</td></tr> <tr><td>45: 10.2</td><td>↗</td></tr> <tr><td>46: 10.0</td><td>←</td></tr> <tr><td>47: 9.8</td><td>↖</td></tr> <tr><td>48: 8.5</td><td>↑</td></tr> <tr><td>49: 7.2</td><td>↑</td></tr> <tr><td>50: 10.0</td><td>→</td></tr> <tr><td colspan="2">Series 84 ( 0x)</td></tr> <tr><td colspan="2">431 ( 6x)</td></tr> </table>	41: 8.6	↖	42: 8.4	↗	43: 7.8	↖	44: 7.0	←	45: 10.2	↗	46: 10.0	←	47: 9.8	↖	48: 8.5	↑	49: 7.2	↑	50: 10.0	→	Series 84 ( 0x)		431 ( 6x)		<table border="1" style="width:100%; border-collapse: collapse;"> <tr><td>51: 9.9</td><td>→</td></tr> <tr><td>52: 9.8</td><td>←</td></tr> <tr><td>53: 10.1</td><td>↘</td></tr> <tr><td>54: 10.5x</td><td>↗</td></tr> <tr><td>55: 10.0</td><td>↘</td></tr> <tr><td>56: 9.6</td><td>↑</td></tr> <tr><td>57: 9.4</td><td>↗</td></tr> <tr><td>58: 9.9</td><td>↘</td></tr> <tr><td>59: 8.1</td><td>↑</td></tr> <tr><td>60: 10.0</td><td>↑</td></tr> <tr><td colspan="2">Series 93 ( 1x)</td></tr> <tr><td colspan="2">524 ( 7x)</td></tr> </table>	51: 9.9	→	52: 9.8	←	53: 10.1	↘	54: 10.5x	↗	55: 10.0	↘	56: 9.6	↑	57: 9.4	↗	58: 9.9	↘	59: 8.1	↑	60: 10.0	↑	Series 93 ( 1x)		524 ( 7x)	
1: 8.0	↓																																																																																																																																																																															
2: 9.4	↘																																																																																																																																																																															
3: 10.7x	↗																																																																																																																																																																															
4: 9.3	→																																																																																																																																																																															
5: 10.8x	↘																																																																																																																																																																															
6: 9.8	↗																																																																																																																																																																															
7: 10.3	↗																																																																																																																																																																															
8: 9.4	→																																																																																																																																																																															
9: 10.3	←																																																																																																																																																																															
Series 84 ( 2x)																																																																																																																																																																																
0 ( 0x)																																																																																																																																																																																
1: 8.0	→																																																																																																																																																																															
2: 10.8x	←																																																																																																																																																																															
3: 8.9	→																																																																																																																																																																															
4: 9.6	↗																																																																																																																																																																															
5: 10.3	↗																																																																																																																																																																															
6: 9.5	↑																																																																																																																																																																															
7: 7.4	↖																																																																																																																																																																															
8: 8.7	↓																																																																																																																																																																															
9: 9.3	↗																																																																																																																																																																															
10: 8.8	↗																																																																																																																																																																															
Series 86 ( 1x)																																																																																																																																																																																
86 ( 1x)																																																																																																																																																																																
11: 9.0	←																																																																																																																																																																															
12: 7.7	↗																																																																																																																																																																															
13: 9.4	↗																																																																																																																																																																															
14: 8.4	↗																																																																																																																																																																															
15: 10.5x	←																																																																																																																																																																															
16: 9.2	↘																																																																																																																																																																															
17: 10.4x	↗																																																																																																																																																																															
18: 9.1	↗																																																																																																																																																																															
19: 10.3	↗																																																																																																																																																																															
20: 10.5x	↘																																																																																																																																																																															
Series 91 ( 3x)																																																																																																																																																																																
177 ( 4x)																																																																																																																																																																																
21: 7.7	↗																																																																																																																																																																															
22: 8.8	↖																																																																																																																																																																															
23: 8.9	↓																																																																																																																																																																															
24: 8.7	←																																																																																																																																																																															
25: 9.5	↖																																																																																																																																																																															
26: 9.5	↓																																																																																																																																																																															
27: 9.8	↗																																																																																																																																																																															
28: 9.6	↑																																																																																																																																																																															
29: 9.2	↖																																																																																																																																																																															
30: 10.8x	←																																																																																																																																																																															
Series 86 ( 1x)																																																																																																																																																																																
263 ( 5x)																																																																																																																																																																																
31: 9.7	↗																																																																																																																																																																															
32: 9.9	→																																																																																																																																																																															
33: 7.6	←																																																																																																																																																																															
34: 8.9	↘																																																																																																																																																																															
35: 8.8	↗																																																																																																																																																																															
36: 9.5	→																																																																																																																																																																															
37: 8.7	→																																																																																																																																																																															
38: 8.7	←																																																																																																																																																																															
39: 10.4x	→																																																																																																																																																																															
40: 8.6	↗																																																																																																																																																																															
Series 84 ( 1x)																																																																																																																																																																																
347 ( 6x)																																																																																																																																																																																
41: 8.6	↖																																																																																																																																																																															
42: 8.4	↗																																																																																																																																																																															
43: 7.8	↖																																																																																																																																																																															
44: 7.0	←																																																																																																																																																																															
45: 10.2	↗																																																																																																																																																																															
46: 10.0	←																																																																																																																																																																															
47: 9.8	↖																																																																																																																																																																															
48: 8.5	↑																																																																																																																																																																															
49: 7.2	↑																																																																																																																																																																															
50: 10.0	→																																																																																																																																																																															
Series 84 ( 0x)																																																																																																																																																																																
431 ( 6x)																																																																																																																																																																																
51: 9.9	→																																																																																																																																																																															
52: 9.8	←																																																																																																																																																																															
53: 10.1	↘																																																																																																																																																																															
54: 10.5x	↗																																																																																																																																																																															
55: 10.0	↘																																																																																																																																																																															
56: 9.6	↑																																																																																																																																																																															
57: 9.4	↗																																																																																																																																																																															
58: 9.9	↘																																																																																																																																																																															
59: 8.1	↑																																																																																																																																																																															
60: 10.0	↑																																																																																																																																																																															
Series 93 ( 1x)																																																																																																																																																																																
524 ( 7x)																																																																																																																																																																																

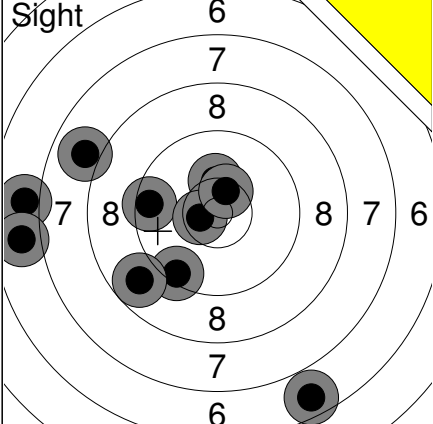
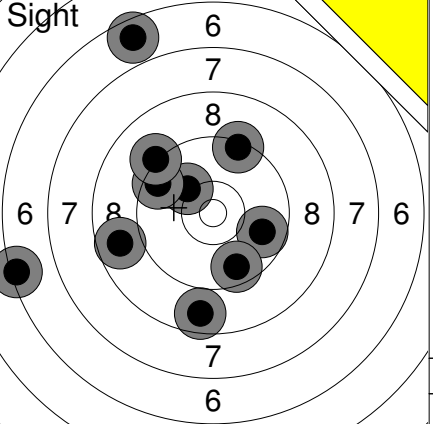
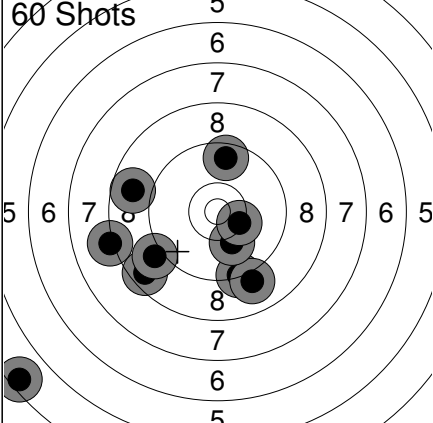
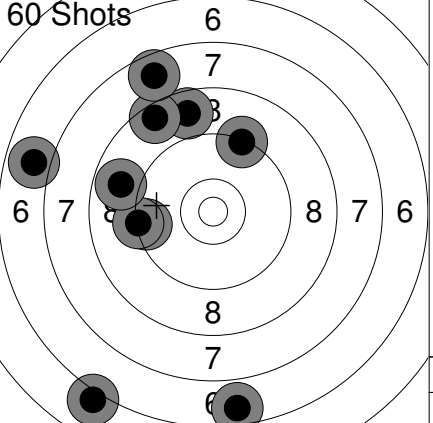
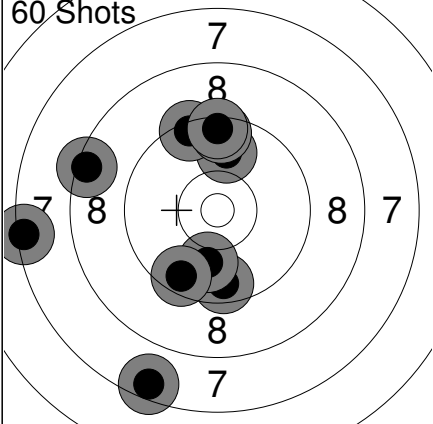
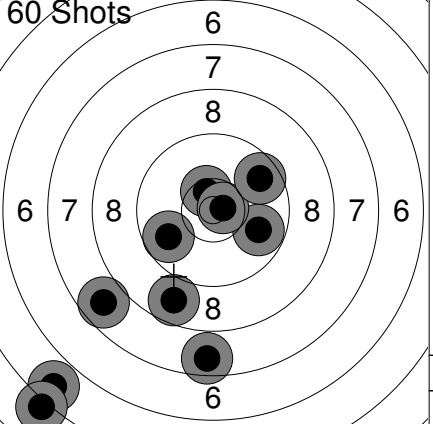
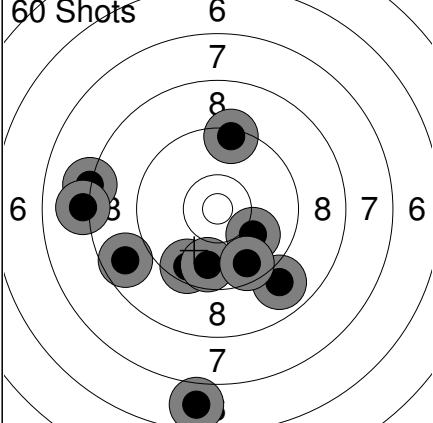
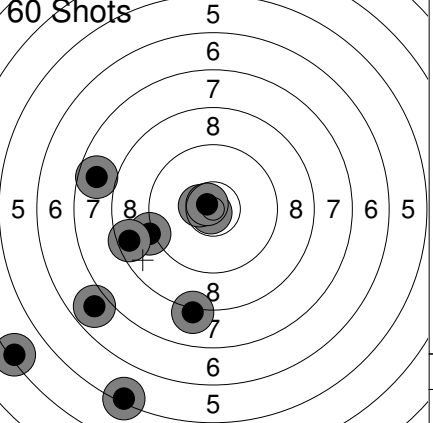
Sight	Sight																																																																									
																																																																										
	<table style="width:100%; border-collapse: collapse;"> <tr><td>1:</td><td>6.6</td><td>↘</td></tr> <tr><td>2:</td><td>6.9</td><td>←</td></tr> <tr><td>3:</td><td>6.8</td><td>←</td></tr> <tr><td>4:</td><td>9.5</td><td>←</td></tr> <tr><td>5:</td><td>7.9</td><td>↖</td></tr> <tr><td>6:</td><td>9.4</td><td>↘</td></tr> <tr><td>7:</td><td>10.3</td><td>↑</td></tr> <tr><td>8:</td><td>8.8</td><td>←</td></tr> <tr><td>9:</td><td>10.6x</td><td>←</td></tr> <tr><td>10:</td><td>10.5x</td><td>↑</td></tr> <tr><td colspan="2">Series</td><td>81 (2x)</td></tr> <tr><td colspan="2"></td><td>0 (0x)</td></tr> </table>	1:	6.6	↘	2:	6.9	←	3:	6.8	←	4:	9.5	←	5:	7.9	↖	6:	9.4	↘	7:	10.3	↑	8:	8.8	←	9:	10.6x	←	10:	10.5x	↑	Series		81 (2x)			0 (0x)	<table style="width:100%; border-collapse: collapse;"> <tr><td>11:</td><td>9.4</td><td>↑</td></tr> <tr><td>12:</td><td>10.2</td><td>↗</td></tr> <tr><td>13:</td><td>9.8</td><td>→</td></tr> <tr><td>14:</td><td>8.7</td><td>↓</td></tr> <tr><td>15:</td><td>6.4</td><td>←</td></tr> <tr><td>16:</td><td>9.5</td><td>↖</td></tr> <tr><td>17:</td><td>6.6</td><td>↑</td></tr> <tr><td>18:</td><td>9.2</td><td>↗</td></tr> <tr><td>19:</td><td>8.8</td><td>←</td></tr> <tr><td>20:</td><td>9.6</td><td>↓</td></tr> <tr><td colspan="2">Series</td><td>83 (0x)</td></tr> <tr><td colspan="2"></td><td>0 (0x)</td></tr> </table>	11:	9.4	↑	12:	10.2	↗	13:	9.8	→	14:	8.7	↓	15:	6.4	←	16:	9.5	↖	17:	6.6	↑	18:	9.2	↗	19:	8.8	←	20:	9.6	↓	Series		83 (0x)			0 (0x)
1:	6.6	↘																																																																								
2:	6.9	←																																																																								
3:	6.8	←																																																																								
4:	9.5	←																																																																								
5:	7.9	↖																																																																								
6:	9.4	↘																																																																								
7:	10.3	↑																																																																								
8:	8.8	←																																																																								
9:	10.6x	←																																																																								
10:	10.5x	↑																																																																								
Series		81 (2x)																																																																								
		0 (0x)																																																																								
11:	9.4	↑																																																																								
12:	10.2	↗																																																																								
13:	9.8	→																																																																								
14:	8.7	↓																																																																								
15:	6.4	←																																																																								
16:	9.5	↖																																																																								
17:	6.6	↑																																																																								
18:	9.2	↗																																																																								
19:	8.8	←																																																																								
20:	9.6	↓																																																																								
Series		83 (0x)																																																																								
		0 (0x)																																																																								
60 Shots	60 Shots																																																																									
																																																																										
	<table style="width:100%; border-collapse: collapse;"> <tr><td>1:</td><td>4.5</td><td>↖</td></tr> <tr><td>2:</td><td>9.3</td><td>↘</td></tr> <tr><td>3:</td><td>9.0</td><td>↘</td></tr> <tr><td>4:</td><td>8.6</td><td>←</td></tr> <tr><td>5:</td><td>8.2</td><td>←</td></tr> <tr><td>6:</td><td>10.1</td><td>↘</td></tr> <tr><td>7:</td><td>9.6</td><td>↑</td></tr> <tr><td>8:</td><td>9.0</td><td>←</td></tr> <tr><td>9:</td><td>10.3</td><td>→</td></tr> <tr><td>10:</td><td>8.8</td><td>←</td></tr> <tr><td colspan="2">Series</td><td>84 (0x)</td></tr> <tr><td colspan="2"></td><td>84 (0x)</td></tr> </table>	1:	4.5	↖	2:	9.3	↘	3:	9.0	↘	4:	8.6	←	5:	8.2	←	6:	10.1	↘	7:	9.6	↑	8:	9.0	←	9:	10.3	→	10:	8.8	←	Series		84 (0x)			84 (0x)	<table style="width:100%; border-collapse: collapse;"> <tr><td>11:</td><td>9.3</td><td>↑</td></tr> <tr><td>12:</td><td>6.6</td><td>↓</td></tr> <tr><td>13:</td><td>8.7</td><td>↑</td></tr> <tr><td>14:</td><td>8.5</td><td>↗</td></tr> <tr><td>15:</td><td>6.9</td><td>←</td></tr> <tr><td>16:</td><td>9.5</td><td>←</td></tr> <tr><td>17:</td><td>9.3</td><td>←</td></tr> <tr><td>18:</td><td>6.0</td><td>↓</td></tr> <tr><td>19:</td><td>7.7</td><td>↑</td></tr> <tr><td>20:</td><td>8.8</td><td>←</td></tr> <tr><td colspan="2">Series</td><td>76 (0x)</td></tr> <tr><td colspan="2"></td><td>160 (0x)</td></tr> </table>	11:	9.3	↑	12:	6.6	↓	13:	8.7	↑	14:	8.5	↗	15:	6.9	←	16:	9.5	←	17:	9.3	←	18:	6.0	↓	19:	7.7	↑	20:	8.8	←	Series		76 (0x)			160 (0x)
1:	4.5	↖																																																																								
2:	9.3	↘																																																																								
3:	9.0	↘																																																																								
4:	8.6	←																																																																								
5:	8.2	←																																																																								
6:	10.1	↘																																																																								
7:	9.6	↑																																																																								
8:	9.0	←																																																																								
9:	10.3	→																																																																								
10:	8.8	←																																																																								
Series		84 (0x)																																																																								
		84 (0x)																																																																								
11:	9.3	↑																																																																								
12:	6.6	↓																																																																								
13:	8.7	↑																																																																								
14:	8.5	↗																																																																								
15:	6.9	←																																																																								
16:	9.5	←																																																																								
17:	9.3	←																																																																								
18:	6.0	↓																																																																								
19:	7.7	↑																																																																								
20:	8.8	←																																																																								
Series		76 (0x)																																																																								
		160 (0x)																																																																								
60 Shots	60 Shots																																																																									
																																																																										
	<table style="width:100%; border-collapse: collapse;"> <tr><td>21:</td><td>8.4</td><td>←</td></tr> <tr><td>22:</td><td>9.9</td><td>↑</td></tr> <tr><td>23:</td><td>9.6</td><td>↘</td></tr> <tr><td>24:</td><td>9.4</td><td>↑</td></tr> <tr><td>25:</td><td>7.3</td><td>←</td></tr> <tr><td>26:</td><td>10.0</td><td>↘</td></tr> <tr><td>27:</td><td>9.5</td><td>↑</td></tr> <tr><td>28:</td><td>9.4</td><td>↑</td></tr> <tr><td>29:</td><td>7.5</td><td>↘</td></tr> <tr><td>30:</td><td>9.6</td><td>↘</td></tr> <tr><td colspan="2">Series</td><td>86 (0x)</td></tr> <tr><td colspan="2"></td><td>246 (0x)</td></tr> </table>	21:	8.4	←	22:	9.9	↑	23:	9.6	↘	24:	9.4	↑	25:	7.3	←	26:	10.0	↘	27:	9.5	↑	28:	9.4	↑	29:	7.5	↘	30:	9.6	↘	Series		86 (0x)			246 (0x)	<table style="width:100%; border-collapse: collapse;"> <tr><td>31:</td><td>9.8</td><td>←</td></tr> <tr><td>32:</td><td>9.8</td><td>→</td></tr> <tr><td>33:</td><td>7.6</td><td>↓</td></tr> <tr><td>34:</td><td>5.6</td><td>↖</td></tr> <tr><td>35:</td><td>10.5x</td><td>↑</td></tr> <tr><td>36:</td><td>8.7</td><td>↘</td></tr> <tr><td>37:</td><td>10.7x</td><td>→</td></tr> <tr><td>38:</td><td>7.7</td><td>←</td></tr> <tr><td>39:</td><td>9.7</td><td>↗</td></tr> <tr><td>40:</td><td>5.1</td><td>↘</td></tr> <tr><td colspan="2">Series</td><td>79 (2x)</td></tr> <tr><td colspan="2"></td><td>325 (2x)</td></tr> </table>	31:	9.8	←	32:	9.8	→	33:	7.6	↓	34:	5.6	↖	35:	10.5x	↑	36:	8.7	↘	37:	10.7x	→	38:	7.7	←	39:	9.7	↗	40:	5.1	↘	Series		79 (2x)			325 (2x)
21:	8.4	←																																																																								
22:	9.9	↑																																																																								
23:	9.6	↘																																																																								
24:	9.4	↑																																																																								
25:	7.3	←																																																																								
26:	10.0	↘																																																																								
27:	9.5	↑																																																																								
28:	9.4	↑																																																																								
29:	7.5	↘																																																																								
30:	9.6	↘																																																																								
Series		86 (0x)																																																																								
		246 (0x)																																																																								
31:	9.8	←																																																																								
32:	9.8	→																																																																								
33:	7.6	↓																																																																								
34:	5.6	↖																																																																								
35:	10.5x	↑																																																																								
36:	8.7	↘																																																																								
37:	10.7x	→																																																																								
38:	7.7	←																																																																								
39:	9.7	↗																																																																								
40:	5.1	↘																																																																								
Series		79 (2x)																																																																								
		325 (2x)																																																																								
60 Shots	60 Shots																																																																									
																																																																										
	<table style="width:100%; border-collapse: collapse;"> <tr><td>41:</td><td>9.4</td><td>↑</td></tr> <tr><td>42:</td><td>6.8</td><td>↘</td></tr> <tr><td>43:</td><td>8.9</td><td>↘</td></tr> <tr><td>44:</td><td>9.6</td><td>↘</td></tr> <tr><td>45:</td><td>10.0</td><td>↘</td></tr> <tr><td>46:</td><td>9.8</td><td>↘</td></tr> <tr><td>47:</td><td>9.6</td><td>↘</td></tr> <tr><td>48:</td><td>8.7</td><td>←</td></tr> <tr><td>49:</td><td>8.2</td><td>←</td></tr> <tr><td>50:</td><td>8.1</td><td>←</td></tr> <tr><td colspan="2">Series</td><td>84 (0x)</td></tr> <tr><td colspan="2"></td><td>409 (2x)</td></tr> </table>	41:	9.4	↑	42:	6.8	↘	43:	8.9	↘	44:	9.6	↘	45:	10.0	↘	46:	9.8	↘	47:	9.6	↘	48:	8.7	←	49:	8.2	←	50:	8.1	←	Series		84 (0x)			409 (2x)	<table style="width:100%; border-collapse: collapse;"> <tr><td>51:</td><td>10.8x</td><td>↘</td></tr> <tr><td>52:</td><td>7.7</td><td>←</td></tr> <tr><td>53:</td><td>10.6x</td><td>←</td></tr> <tr><td>54:</td><td>4.4</td><td>←</td></tr> <tr><td>55:</td><td>8.1</td><td>↓</td></tr> <tr><td>56:</td><td>10.7x</td><td>↖</td></tr> <tr><td>57:</td><td>6.8</td><td>↖</td></tr> <tr><td>58:</td><td>5.3</td><td>↓</td></tr> <tr><td>59:</td><td>9.1</td><td>←</td></tr> <tr><td>60:</td><td>8.6</td><td>←</td></tr> <tr><td colspan="2">Series</td><td>77 (3x)</td></tr> <tr><td colspan="2"></td><td>486 (5x)</td></tr> </table>	51:	10.8x	↘	52:	7.7	←	53:	10.6x	←	54:	4.4	←	55:	8.1	↓	56:	10.7x	↖	57:	6.8	↖	58:	5.3	↓	59:	9.1	←	60:	8.6	←	Series		77 (3x)			486 (5x)
41:	9.4	↑																																																																								
42:	6.8	↘																																																																								
43:	8.9	↘																																																																								
44:	9.6	↘																																																																								
45:	10.0	↘																																																																								
46:	9.8	↘																																																																								
47:	9.6	↘																																																																								
48:	8.7	←																																																																								
49:	8.2	←																																																																								
50:	8.1	←																																																																								
Series		84 (0x)																																																																								
		409 (2x)																																																																								
51:	10.8x	↘																																																																								
52:	7.7	←																																																																								
53:	10.6x	←																																																																								
54:	4.4	←																																																																								
55:	8.1	↓																																																																								
56:	10.7x	↖																																																																								
57:	6.8	↖																																																																								
58:	5.3	↓																																																																								
59:	9.1	←																																																																								
60:	8.6	←																																																																								
Series		77 (3x)																																																																								
		486 (5x)																																																																								

	<table border="1" style="width:100%; border-collapse: collapse;"> <tr><td>1:</td><td>10.7x</td><td>↗</td></tr> <tr><td>2:</td><td>9.7</td><td>↓</td></tr> <tr><td>3:</td><td>7.4</td><td>→</td></tr> <tr><td>4:</td><td>7.8</td><td>→</td></tr> <tr><td>5:</td><td>8.4</td><td>→</td></tr> <tr><td>6:</td><td>8.6</td><td>↘</td></tr> <tr><td>7:</td><td>7.0</td><td>↘</td></tr> <tr><td>8:</td><td>10.1</td><td>→</td></tr> <tr><td>9:</td><td>6.9</td><td>↓</td></tr> <tr><td>10:</td><td>8.7</td><td>↘</td></tr> <tr><td colspan="2">Series</td><td>80 (1x)</td></tr> <tr><td colspan="2"></td><td>0 (0x)</td></tr> </table>	1:	10.7x	↗	2:	9.7	↓	3:	7.4	→	4:	7.8	→	5:	8.4	→	6:	8.6	↘	7:	7.0	↘	8:	10.1	→	9:	6.9	↓	10:	8.7	↘	Series		80 (1x)			0 (0x)		<table border="1" style="width:100%; border-collapse: collapse;"> <tr><td>1:</td><td>9.9</td><td>↗</td></tr> <tr><td>2:</td><td>9.2</td><td>↓</td></tr> <tr><td>3:</td><td>9.8</td><td>↘</td></tr> <tr><td>4:</td><td>9.2</td><td>↗</td></tr> <tr><td>5:</td><td>8.0</td><td>↓</td></tr> <tr><td>6:</td><td>8.3</td><td>↘</td></tr> <tr><td>7:</td><td>8.7</td><td>→</td></tr> <tr><td>8:</td><td>8.2</td><td>↘</td></tr> <tr><td>9:</td><td>9.5</td><td>↗</td></tr> <tr><td>10:</td><td>7.0</td><td>→</td></tr> <tr><td colspan="2">Series</td><td>84 (0x)</td></tr> <tr><td colspan="2"></td><td>84 (0x)</td></tr> </table>	1:	9.9	↗	2:	9.2	↓	3:	9.8	↘	4:	9.2	↗	5:	8.0	↓	6:	8.3	↘	7:	8.7	→	8:	8.2	↘	9:	9.5	↗	10:	7.0	→	Series		84 (0x)			84 (0x)
1:	10.7x	↗																																																																									
2:	9.7	↓																																																																									
3:	7.4	→																																																																									
4:	7.8	→																																																																									
5:	8.4	→																																																																									
6:	8.6	↘																																																																									
7:	7.0	↘																																																																									
8:	10.1	→																																																																									
9:	6.9	↓																																																																									
10:	8.7	↘																																																																									
Series		80 (1x)																																																																									
		0 (0x)																																																																									
1:	9.9	↗																																																																									
2:	9.2	↓																																																																									
3:	9.8	↘																																																																									
4:	9.2	↗																																																																									
5:	8.0	↓																																																																									
6:	8.3	↘																																																																									
7:	8.7	→																																																																									
8:	8.2	↘																																																																									
9:	9.5	↗																																																																									
10:	7.0	→																																																																									
Series		84 (0x)																																																																									
		84 (0x)																																																																									
	<table border="1" style="width:100%; border-collapse: collapse;"> <tr><td>11:</td><td>8.5</td><td>↗</td></tr> <tr><td>12:</td><td>8.2</td><td>↘</td></tr> <tr><td>13:</td><td>7.5</td><td>→</td></tr> <tr><td>14:</td><td>9.1</td><td>←</td></tr> <tr><td>15:</td><td>10.6x</td><td>→</td></tr> <tr><td>16:</td><td>7.7</td><td>↗</td></tr> <tr><td>17:</td><td>8.7</td><td>←</td></tr> <tr><td>18:</td><td>7.8</td><td>↓</td></tr> <tr><td>19:</td><td>6.7</td><td>←</td></tr> <tr><td>20:</td><td>9.5</td><td>↓</td></tr> <tr><td colspan="2">Series</td><td>79 (1x)</td></tr> <tr><td colspan="2"></td><td>163 (1x)</td></tr> </table>	11:	8.5	↗	12:	8.2	↘	13:	7.5	→	14:	9.1	←	15:	10.6x	→	16:	7.7	↗	17:	8.7	←	18:	7.8	↓	19:	6.7	←	20:	9.5	↓	Series		79 (1x)			163 (1x)		<table border="1" style="width:100%; border-collapse: collapse;"> <tr><td>21:</td><td>9.4</td><td>↘</td></tr> <tr><td>22:</td><td>9.3</td><td>←</td></tr> <tr><td>23:</td><td>9.6</td><td>←</td></tr> <tr><td>24:</td><td>9.5</td><td>←</td></tr> <tr><td>25:</td><td>8.2</td><td>↘</td></tr> <tr><td>26:</td><td>9.4</td><td>→</td></tr> <tr><td>27:</td><td>9.6</td><td>→</td></tr> <tr><td>28:</td><td>10.1</td><td>←</td></tr> <tr><td>29:</td><td>10.6x</td><td>↓</td></tr> <tr><td>30:</td><td>8.9</td><td>↓</td></tr> <tr><td colspan="2">Series</td><td>90 (1x)</td></tr> <tr><td colspan="2"></td><td>253 (2x)</td></tr> </table>	21:	9.4	↘	22:	9.3	←	23:	9.6	←	24:	9.5	←	25:	8.2	↘	26:	9.4	→	27:	9.6	→	28:	10.1	←	29:	10.6x	↓	30:	8.9	↓	Series		90 (1x)			253 (2x)
11:	8.5	↗																																																																									
12:	8.2	↘																																																																									
13:	7.5	→																																																																									
14:	9.1	←																																																																									
15:	10.6x	→																																																																									
16:	7.7	↗																																																																									
17:	8.7	←																																																																									
18:	7.8	↓																																																																									
19:	6.7	←																																																																									
20:	9.5	↓																																																																									
Series		79 (1x)																																																																									
		163 (1x)																																																																									
21:	9.4	↘																																																																									
22:	9.3	←																																																																									
23:	9.6	←																																																																									
24:	9.5	←																																																																									
25:	8.2	↘																																																																									
26:	9.4	→																																																																									
27:	9.6	→																																																																									
28:	10.1	←																																																																									
29:	10.6x	↓																																																																									
30:	8.9	↓																																																																									
Series		90 (1x)																																																																									
		253 (2x)																																																																									
	<table border="1" style="width:100%; border-collapse: collapse;"> <tr><td>31:</td><td>6.1</td><td>↘</td></tr> <tr><td>32:</td><td>8.9</td><td>↘</td></tr> <tr><td>33:</td><td>9.0</td><td>↖</td></tr> <tr><td>34:</td><td>7.3</td><td>↓</td></tr> <tr><td>35:</td><td>8.3</td><td>←</td></tr> <tr><td>36:</td><td>8.8</td><td>↓</td></tr> <tr><td>37:</td><td>9.6</td><td>↓</td></tr> <tr><td>38:</td><td>8.8</td><td>↓</td></tr> <tr><td>39:</td><td>9.7</td><td>→</td></tr> <tr><td>40:</td><td>7.6</td><td>←</td></tr> <tr><td colspan="2">Series</td><td>79 (0x)</td></tr> <tr><td colspan="2"></td><td>332 (2x)</td></tr> </table>	31:	6.1	↘	32:	8.9	↘	33:	9.0	↖	34:	7.3	↓	35:	8.3	←	36:	8.8	↓	37:	9.6	↓	38:	8.8	↓	39:	9.7	→	40:	7.6	←	Series		79 (0x)			332 (2x)		<table border="1" style="width:100%; border-collapse: collapse;"> <tr><td>41:</td><td>6.9</td><td>→</td></tr> <tr><td>42:</td><td>9.2</td><td>←</td></tr> <tr><td>43:</td><td>7.4</td><td>↓</td></tr> <tr><td>44:</td><td>8.5</td><td>↓</td></tr> <tr><td>45:</td><td>9.6</td><td>←</td></tr> <tr><td>46:</td><td>9.2</td><td>↗</td></tr> <tr><td>47:</td><td>9.5</td><td>↓</td></tr> <tr><td>48:</td><td>9.8</td><td>↘</td></tr> <tr><td>49:</td><td>5.6</td><td>↘</td></tr> <tr><td>50:</td><td>10.3</td><td>↑</td></tr> <tr><td colspan="2">Series</td><td>81 (0x)</td></tr> <tr><td colspan="2"></td><td>413 (2x)</td></tr> </table>	41:	6.9	→	42:	9.2	←	43:	7.4	↓	44:	8.5	↓	45:	9.6	←	46:	9.2	↗	47:	9.5	↓	48:	9.8	↘	49:	5.6	↘	50:	10.3	↑	Series		81 (0x)			413 (2x)
31:	6.1	↘																																																																									
32:	8.9	↘																																																																									
33:	9.0	↖																																																																									
34:	7.3	↓																																																																									
35:	8.3	←																																																																									
36:	8.8	↓																																																																									
37:	9.6	↓																																																																									
38:	8.8	↓																																																																									
39:	9.7	→																																																																									
40:	7.6	←																																																																									
Series		79 (0x)																																																																									
		332 (2x)																																																																									
41:	6.9	→																																																																									
42:	9.2	←																																																																									
43:	7.4	↓																																																																									
44:	8.5	↓																																																																									
45:	9.6	←																																																																									
46:	9.2	↗																																																																									
47:	9.5	↓																																																																									
48:	9.8	↘																																																																									
49:	5.6	↘																																																																									
50:	10.3	↑																																																																									
Series		81 (0x)																																																																									
		413 (2x)																																																																									
	<table border="1" style="width:100%; border-collapse: collapse;"> <tr><td>51:</td><td>9.7</td><td>←</td></tr> <tr><td>52:</td><td>8.0</td><td>↘</td></tr> <tr><td>53:</td><td>7.5</td><td>↗</td></tr> <tr><td>54:</td><td>8.1</td><td>←</td></tr> <tr><td>55:</td><td>8.0</td><td>←</td></tr> <tr><td>56:</td><td>10.7x</td><td>↑</td></tr> <tr><td>57:</td><td>10.0</td><td>↓</td></tr> <tr><td>58:</td><td>9.2</td><td>→</td></tr> <tr><td>59:</td><td>9.1</td><td>↘</td></tr> <tr><td>60:</td><td>8.1</td><td>↓</td></tr> <tr><td colspan="2">Series</td><td>86 (1x)</td></tr> <tr><td colspan="2"></td><td>499 (3x)</td></tr> </table>	51:	9.7	←	52:	8.0	↘	53:	7.5	↗	54:	8.1	←	55:	8.0	←	56:	10.7x	↑	57:	10.0	↓	58:	9.2	→	59:	9.1	↘	60:	8.1	↓	Series		86 (1x)			499 (3x)																																						
51:	9.7	←																																																																									
52:	8.0	↘																																																																									
53:	7.5	↗																																																																									
54:	8.1	←																																																																									
55:	8.0	←																																																																									
56:	10.7x	↑																																																																									
57:	10.0	↓																																																																									
58:	9.2	→																																																																									
59:	9.1	↘																																																																									
60:	8.1	↓																																																																									
Series		86 (1x)																																																																									
		499 (3x)																																																																									

Relay **1** Lane **25** **NORMAN Seth**

2023 SFC Pistol Nationals SK IJ MP

16.07.2023 23PN-AP-Q2 Alberta Handgun Association

Comment Signature

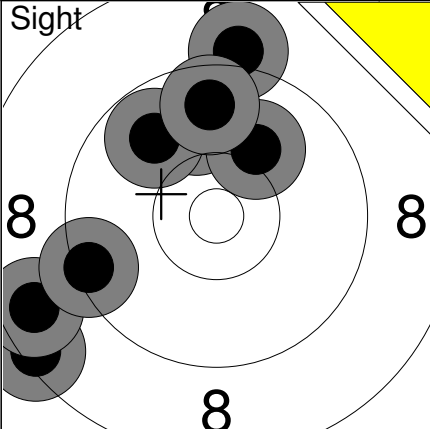
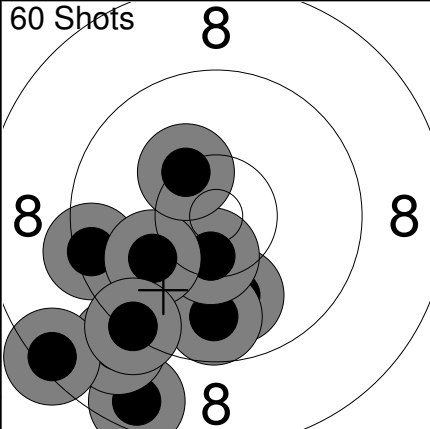
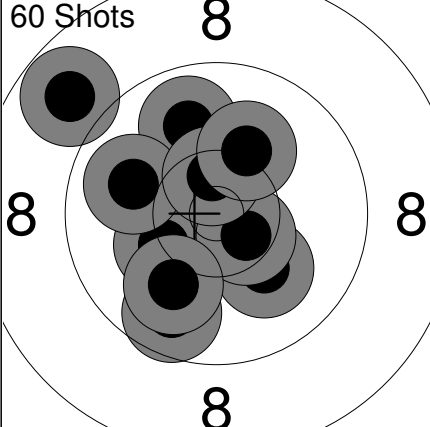
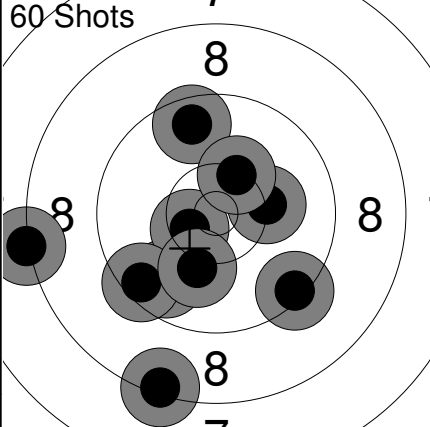
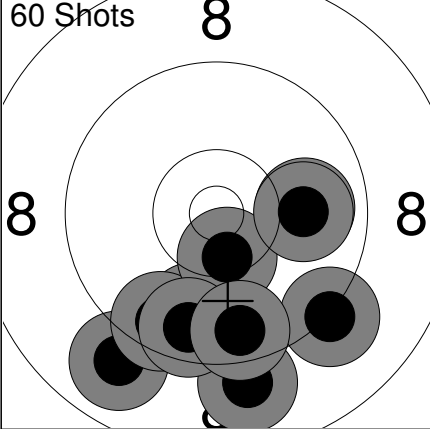
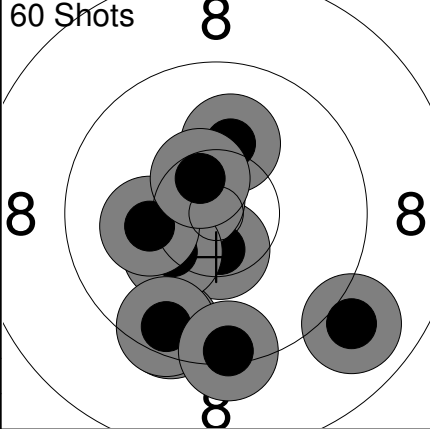
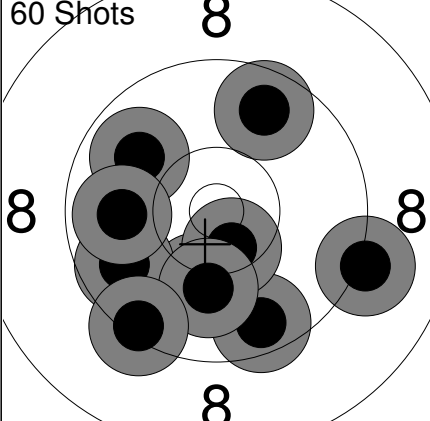
	1: 9.9 ↑ 2: 8.4 ↙ 3: 9.8 ↗ 4: 10.1 ↗ 5: 9.1 ↑ 6: 8.6 ↙ 7: 9.7 ↑ 8: 9.4 ↙		1: 10.0 ↓ 2: 9.8 ↓ 3: 9.4 ↙ 4: 8.6 ↙ 5: 10.5x ↓ 6: 9.0 ↙ 7: 8.4 ↙ 8: 10.0 ↙ 9: 9.3 ↙ 10: 10.3 ↗
	Series 71 (0x) 0 (0x)		Series 92 (1x) 92 (1x)
	11: 9.9 ↑ 12: 10.1 ↓ 13: 10.3 ↙ 14: 10.5x ↘ 15: 9.9 ↗ 16: 10.5x ↗ 17: 9.7 ↘ 18: 10.0 ↘ 19: 10.2 ↗ 20: 8.8 ↗		21: 9.4 ↘ 22: 9.8 ↘ 23: 10.2 → 24: 9.6 ↗ 25: 10.5x ↙ 26: 9.5 ↙ 27: 8.2 ↙ 28: 10.3 ↗ 29: 10.1 ↓ 30: 8.3 ↓
	Series 95 (2x) 187 (3x)		Series 92 (1x) 279 (4x)
	31: 9.8 ↓ 32: 8.9 ↘ 33: 9.9 → 34: 9.0 ↓ 35: 9.6 ↘ 36: 10.4x ↘ 37: 9.6 ↘ 38: 10.0 → 39: 9.2 ↘ 40: 9.6 ↓		41: 10.5x ↓ 42: 10.7x ↗ 43: 9.5 ↘ 44: 9.0 ↘ 45: 10.3 ↙ 46: 9.5 ↘ 47: 9.4 ↘ 48: 10.1 ↗ 49: 10.2 ↙ 50: 10.5x ↗
	Series 91 (1x) 370 (5x)		Series 96 (3x) 466 (8x)
	51: 10.1 ↓ 52: 9.7 ↙ 53: 9.6 ↘ 54: 10.5x ↘ 55: 10.1 ↘ 56: 9.9 ↗ 57: 9.4 ↙ 58: 9.7 ↗ 59: 9.9 ↙ 60: 9.1 →		
	Series 93 (1x) 559 (9x)		



Relay **1** Lane **26** **WANG Hejia**

2023 SFC Pistol Nationals BC JR MP

16.07.2023 23PN-AP-Q2 Alberta Handgun Association

Comment Signature

	1: 9.3 →		11: 9.8 ↓
	2: 9.9 ↓		12: 8.7 ↑
	3: 9.9 →		13: 8.7 ↖
	4: 9.5 ↓		14: 8.3 ↓
	5: 9.8 ↓		15: 10.0 ↑
	6: 9.7 →		16: 10.1 ↗
	7: 8.3 →		17: 8.4 ←
	8: 9.6 ↓		18: 9.4 ↗
	9: 9.9 ↓		19: 10.0 ↓
	10: 6.5 →		20: 9.1 ↑
Series 86 (0x)		Series 89 (0x)	
0 (0x)		0 (0x)	

	1: 8.8 ↓		11: 9.6 ↑
	2: 10.2 ←		12: 9.3 ↗
	3: 9.3 ↓		13: 9.4 ↓
	4: 9.8 ↗		14: 10.0 ↑
	5: 9.2 ↑		15: 10.2 ↗
	6: 9.5 ↑		16: 8.9 ↗
	7: 9.5 ↓		17: 9.6 ←
	8: 9.3 ←		18: 10.4x ↓
	9: 9.3 ↑		19: 8.0 ↓
	10: 8.3 ↗		20: 10.2 ←
Series 89 (0x)		Series 92 (1x)	
89 (0x)		181 (1x)	

	21: 8.4 ↓		31: 10.3 ←
	22: 10.3 ↓		32: 9.2 ↓
	23: 8.5 ↓		33: 10.2 ↓
	24: 7.2 ↑		34: 7.6 ←
	25: 8.4 ←		35: 10.6x ↓
	26: 10.1 ←		36: 9.3 →
	27: 9.0 ←		37: 8.7 ←
	28: 10.0 ↗		38: 10.3 ↓
	29: 9.8 ↓		39: 9.2 ←
	30: 10.1 ↑		40: 10.3 ↗
Series 89 (0x)		Series 92 (1x)	
270 (1x)		362 (2x)	

	41: 10.6x ↗		51: 9.8 →
	42: 9.2 ↓		52: 10.0 ↗
	43: 10.4x ↗		53: 8.9 ↑
	44: 6.9 ↗		54: 8.7 →
	45: 9.4 ↗		55: 10.7x ↓
	46: 8.6 ←		56: 10.2 →
	47: 9.5 →		57: 10.7x ↑
	48: 10.9x ←		58: 9.3 ↑
	49: 10.0 ↓		59: 10.3 ↗
	50: 9.1 ↘		60: 9.4 ↗
Series 90 (3x)		Series 93 (2x)	
452 (5x)		545 (7x)	



Relay **1** Lane **27** **NADON William**

2023 SFC Pistol Nationals QC JR MP

16.07.2023 23PN-AP-Q2 Alberta Handgun Association

Comment Signature

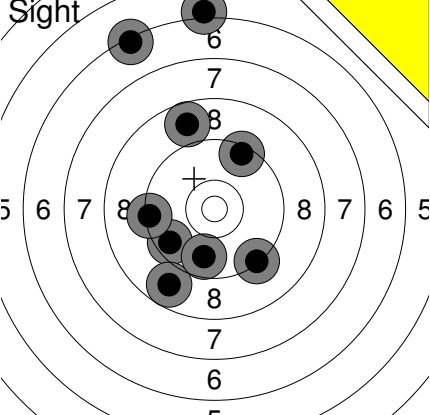
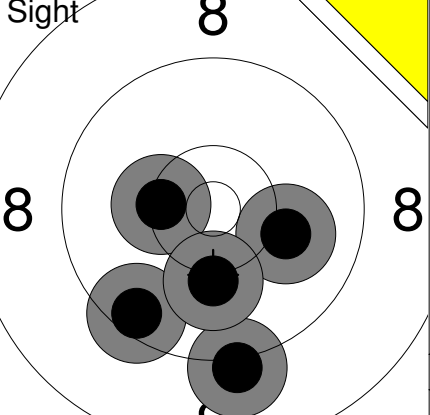
Sight 	1: 6.3 ↗	Sight <b>8</b> 	11: 10.1 →
	2: 9.6 ↙		12: 9.5 ↙
	3: 9.4 ↗		13: 9.1 ↓
	4: 8.8 ↙		14: 10.4x ←
	5: 8.7 ↗		15: 10.1 ↓
	6: 9.3 ←		
	7: 9.3 ↘		
	8: 9.7 ↓		
	10: 6.1 ↑		
Series	73 (0x)	Series	48 (1x)
	0 (0x)		0 (0x)

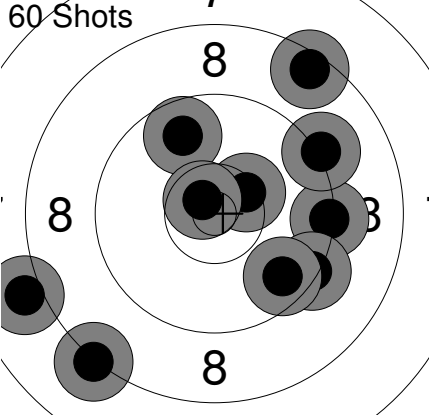
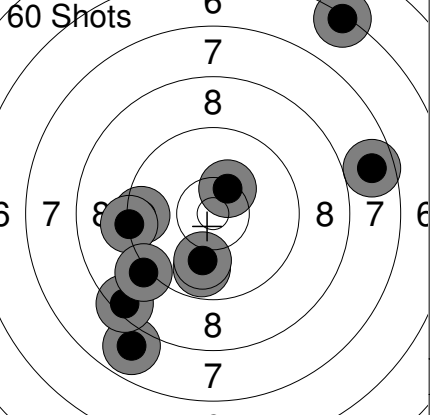
60 Shots 	1: 9.3 →	60 Shots 	11: 7.9 ↘
	2: 8.2 ↙		12: 6.3 ↗
	3: 8.0 ←		13: 9.8 ↓
	4: 9.3 →		14: 9.5 ←
	5: 8.5 ↗		15: 8.4 ↘
	6: 9.2 ↗		16: 9.3 ←
	7: 10.4x →		17: 10.4x ↗
	8: 9.7 ↗		18: 7.7 →
	9: 10.7x ↗		19: 10.0 ↓
	10: 9.6 ↘		20: 9.1 ↘
Series	89 (2x)	Series	84 (1x)
	89 (2x)		173 (3x)

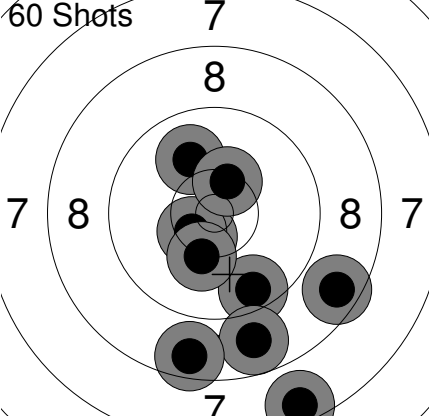
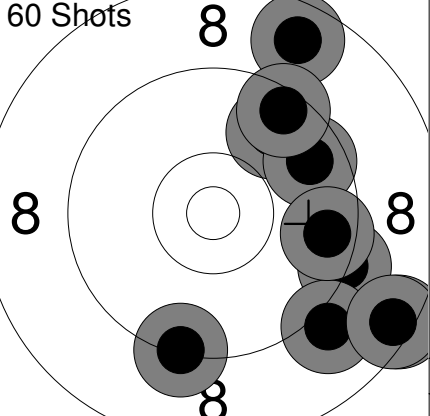
60 Shots 	21: 9.6 ↓	60 Shots 	31: 9.8 ↗
	22: 8.8 ↓		32: 9.3 ↓
	23: 10.5x ↓		33: 9.3 →
	24: 8.6 ↓		34: 9.0 ↘
	25: 10.5x ↙		35: 9.7 ↗
	26: 10.2 ↓		36: 8.7 ↗
	27: 10.0 ↙		37: 9.6 →
	28: 10.4x ↗		38: 9.5 ↗
	29: 7.5 ↓		39: 8.4 ↘
	30: 8.6 ↘		40: 8.5 ↘
Series	90 (3x)	Series	87 (0x)
	263 (6x)		350 (6x)

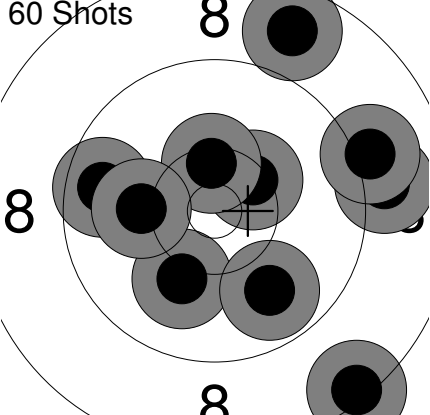
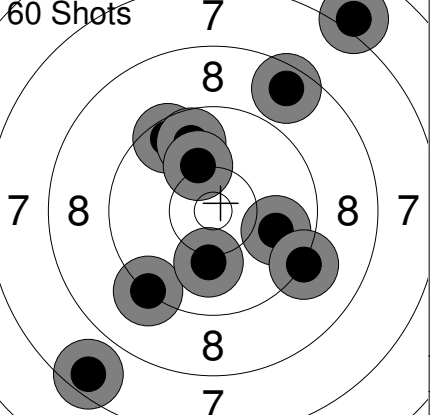
60 Shots 	41: 10.1 ↘	60 Shots 	51: 9.2 ↘
	42: 8.4 ↘		52: 9.5 ↗
	43: 9.0 →		53: 7.6 ↘
	44: 10.4x ↗		54: 9.9 →
	45: 9.7 ↙		55: 7.0 ↗
	46: 8.7 ↗		56: 9.8 ↗
	47: 9.8 ↘		57: 10.1 ↓
	48: 9.1 →		58: 9.2 ↘
	49: 10.4x ↑		59: 10.2 ↗
	50: 10.1 ←		60: 8.6 ↗
Series	92 (2x)	Series	87 (0x)
	442 (8x)		529 (8x)

Relay <b>1</b>	Lane <b>28</b>	<b>NORMAN Rex</b>
-------------------	-------------------	-------------------

2023 SFC Pistol Nationals SK	JR	MP
------------------------------	----	----

16.07.2023	23PN-AP-Q2	Alberta Handgun Association
------------	------------	-----------------------------

Comment	Signature
---------	-----------

<p>Sight</p>	<table border="1" style="width:100%; border-collapse: collapse;"> <tr><td>1:</td><td>8.2</td><td>↖</td></tr> <tr><td>2:</td><td>7.9</td><td>←</td></tr> <tr><td>3:</td><td>7.7</td><td>←</td></tr> <tr><td>4:</td><td>9.7</td><td>←</td></tr> <tr><td>5:</td><td>5.7</td><td>←</td></tr> <tr><td>6:</td><td>8.2</td><td>↗</td></tr> <tr><td>7:</td><td>9.8</td><td>→</td></tr> <tr><td>8:</td><td>9.4</td><td>←</td></tr> <tr><td>9:</td><td>9.7</td><td>↗</td></tr> <tr><td>10:</td><td>9.5</td><td>↓</td></tr> <tr><td colspan="2">Series</td><td>80 (0x)</td></tr> <tr><td colspan="2"></td><td>0 (0x)</td></tr> </table>	1:	8.2	↖	2:	7.9	←	3:	7.7	←	4:	9.7	←	5:	5.7	←	6:	8.2	↗	7:	9.8	→	8:	9.4	←	9:	9.7	↗	10:	9.5	↓	Series		80 (0x)			0 (0x)	<p>Sight</p>	<table border="1" style="width:100%; border-collapse: collapse;"> <tr><td>11:</td><td>10.0</td><td>↘</td></tr> <tr><td>12:</td><td>8.6</td><td>↗</td></tr> <tr><td>13:</td><td>9.7</td><td>↗</td></tr> <tr><td>14:</td><td>9.4</td><td>↓</td></tr> <tr><td colspan="2">Series</td><td>36 (0x)</td></tr> <tr><td colspan="2"></td><td>0 (0x)</td></tr> </table>	11:	10.0	↘	12:	8.6	↗	13:	9.7	↗	14:	9.4	↓	Series		36 (0x)			0 (0x)																		
1:	8.2	↖																																																																									
2:	7.9	←																																																																									
3:	7.7	←																																																																									
4:	9.7	←																																																																									
5:	5.7	←																																																																									
6:	8.2	↗																																																																									
7:	9.8	→																																																																									
8:	9.4	←																																																																									
9:	9.7	↗																																																																									
10:	9.5	↓																																																																									
Series		80 (0x)																																																																									
		0 (0x)																																																																									
11:	10.0	↘																																																																									
12:	8.6	↗																																																																									
13:	9.7	↗																																																																									
14:	9.4	↓																																																																									
Series		36 (0x)																																																																									
		0 (0x)																																																																									
<p>60 Shots</p>	<table border="1" style="width:100%; border-collapse: collapse;"> <tr><td>1:</td><td>7.6</td><td>←</td></tr> <tr><td>2:</td><td>9.1</td><td>↗</td></tr> <tr><td>3:</td><td>9.1</td><td>←</td></tr> <tr><td>4:</td><td>8.6</td><td>↗</td></tr> <tr><td>5:</td><td>8.4</td><td>↓</td></tr> <tr><td>6:</td><td>9.0</td><td>↘</td></tr> <tr><td>7:</td><td>8.9</td><td>↘</td></tr> <tr><td>8:</td><td>9.9</td><td>↗</td></tr> <tr><td>9:</td><td>9.8</td><td>↓</td></tr> <tr><td>10:</td><td>9.7</td><td>←</td></tr> <tr><td colspan="2">Series</td><td>85 (0x)</td></tr> <tr><td colspan="2"></td><td>85 (0x)</td></tr> </table>	1:	7.6	←	2:	9.1	↗	3:	9.1	←	4:	8.6	↗	5:	8.4	↓	6:	9.0	↘	7:	8.9	↘	8:	9.9	↗	9:	9.8	↓	10:	9.7	←	Series		85 (0x)			85 (0x)	<p>60 Shots</p>	<table border="1" style="width:100%; border-collapse: collapse;"> <tr><td>11:</td><td>9.3</td><td>↓</td></tr> <tr><td>12:</td><td>9.3</td><td>←</td></tr> <tr><td>13:</td><td>9.5</td><td>↖</td></tr> <tr><td>14:</td><td>9.9</td><td>↗</td></tr> <tr><td>15:</td><td>9.3</td><td>↘</td></tr> <tr><td>16:</td><td>9.7</td><td>→</td></tr> <tr><td>17:</td><td>6.8</td><td>↘</td></tr> <tr><td>18:</td><td>8.4</td><td>↗</td></tr> <tr><td>19:</td><td>10.3</td><td>↘</td></tr> <tr><td>20:</td><td>10.1</td><td>↘</td></tr> <tr><td colspan="2">Series</td><td>88 (0x)</td></tr> <tr><td colspan="2"></td><td>173 (0x)</td></tr> </table>	11:	9.3	↓	12:	9.3	←	13:	9.5	↖	14:	9.9	↗	15:	9.3	↘	16:	9.7	→	17:	6.8	↘	18:	8.4	↗	19:	10.3	↘	20:	10.1	↘	Series		88 (0x)			173 (0x)
1:	7.6	←																																																																									
2:	9.1	↗																																																																									
3:	9.1	←																																																																									
4:	8.6	↗																																																																									
5:	8.4	↓																																																																									
6:	9.0	↘																																																																									
7:	8.9	↘																																																																									
8:	9.9	↗																																																																									
9:	9.8	↓																																																																									
10:	9.7	←																																																																									
Series		85 (0x)																																																																									
		85 (0x)																																																																									
11:	9.3	↓																																																																									
12:	9.3	←																																																																									
13:	9.5	↖																																																																									
14:	9.9	↗																																																																									
15:	9.3	↘																																																																									
16:	9.7	→																																																																									
17:	6.8	↘																																																																									
18:	8.4	↗																																																																									
19:	10.3	↘																																																																									
20:	10.1	↘																																																																									
Series		88 (0x)																																																																									
		173 (0x)																																																																									
<p>60 Shots</p>	<table border="1" style="width:100%; border-collapse: collapse;"> <tr><td>21:</td><td>8.3</td><td>↗</td></tr> <tr><td>22:</td><td>9.3</td><td>↘</td></tr> <tr><td>23:</td><td>9.9</td><td>↗</td></tr> <tr><td>24:</td><td>10.0</td><td>→</td></tr> <tr><td>25:</td><td>9.9</td><td>→</td></tr> <tr><td>26:</td><td>9.6</td><td>↘</td></tr> <tr><td>27:</td><td>8.5</td><td>↗</td></tr> <tr><td>28:</td><td>9.8</td><td>↘</td></tr> <tr><td>29:</td><td>8.5</td><td>↗</td></tr> <tr><td>30:</td><td>8.6</td><td>↓</td></tr> <tr><td colspan="2">Series</td><td>87 (0x)</td></tr> <tr><td colspan="2"></td><td>260 (0x)</td></tr> </table>	21:	8.3	↗	22:	9.3	↘	23:	9.9	↗	24:	10.0	→	25:	9.9	→	26:	9.6	↘	27:	8.5	↗	28:	9.8	↘	29:	8.5	↗	30:	8.6	↓	Series		87 (0x)			260 (0x)	<p>60 Shots</p>	<table border="1" style="width:100%; border-collapse: collapse;"> <tr><td>31:</td><td>7.9</td><td>↗</td></tr> <tr><td>32:</td><td>8.3</td><td>↘</td></tr> <tr><td>33:</td><td>9.2</td><td>↘</td></tr> <tr><td>34:</td><td>9.1</td><td>↗</td></tr> <tr><td>35:</td><td>9.9</td><td>↘</td></tr> <tr><td>36:</td><td>9.5</td><td>↘</td></tr> <tr><td>37:</td><td>8.6</td><td>↓</td></tr> <tr><td>38:</td><td>9.6</td><td>↗</td></tr> <tr><td>39:</td><td>10.2</td><td>←</td></tr> <tr><td>40:</td><td>8.8</td><td>↓</td></tr> <tr><td colspan="2">Series</td><td>86 (0x)</td></tr> <tr><td colspan="2"></td><td>346 (0x)</td></tr> </table>	31:	7.9	↗	32:	8.3	↘	33:	9.2	↘	34:	9.1	↗	35:	9.9	↘	36:	9.5	↘	37:	8.6	↓	38:	9.6	↗	39:	10.2	←	40:	8.8	↓	Series		86 (0x)			346 (0x)
21:	8.3	↗																																																																									
22:	9.3	↘																																																																									
23:	9.9	↗																																																																									
24:	10.0	→																																																																									
25:	9.9	→																																																																									
26:	9.6	↘																																																																									
27:	8.5	↗																																																																									
28:	9.8	↘																																																																									
29:	8.5	↗																																																																									
30:	8.6	↓																																																																									
Series		87 (0x)																																																																									
		260 (0x)																																																																									
31:	7.9	↗																																																																									
32:	8.3	↘																																																																									
33:	9.2	↘																																																																									
34:	9.1	↗																																																																									
35:	9.9	↘																																																																									
36:	9.5	↘																																																																									
37:	8.6	↓																																																																									
38:	9.6	↗																																																																									
39:	10.2	←																																																																									
40:	8.8	↓																																																																									
Series		86 (0x)																																																																									
		346 (0x)																																																																									
<p>60 Shots</p>	<table border="1" style="width:100%; border-collapse: collapse;"> <tr><td>41:</td><td>10.1</td><td>→</td></tr> <tr><td>42:</td><td>9.3</td><td>←</td></tr> <tr><td>43:</td><td>9.2</td><td>↖</td></tr> <tr><td>44:</td><td>10.2</td><td>↓</td></tr> <tr><td>45:</td><td>10.0</td><td>↗</td></tr> <tr><td>46:</td><td>9.6</td><td>↗</td></tr> <tr><td>47:</td><td>9.4</td><td>↘</td></tr> <tr><td>48:</td><td>10.4</td><td>↗</td></tr> <tr><td>49:</td><td>8.9</td><td>↘</td></tr> <tr><td>50:</td><td>9.1</td><td>→</td></tr> <tr><td colspan="2">Series</td><td>93 (0x)</td></tr> <tr><td colspan="2"></td><td>439 (0x)</td></tr> </table>	41:	10.1	→	42:	9.3	←	43:	9.2	↖	44:	10.2	↓	45:	10.0	↗	46:	9.6	↗	47:	9.4	↘	48:	10.4	↗	49:	8.9	↘	50:	9.1	→	Series		93 (0x)			439 (0x)	<p>60 Shots</p>	<table border="1" style="width:100%; border-collapse: collapse;"> <tr><td>51:</td><td>9.3</td><td>↘</td></tr> <tr><td>52:</td><td>10.1</td><td>↘</td></tr> <tr><td>53:</td><td>9.3</td><td>↗</td></tr> <tr><td>54:</td><td>9.0</td><td>←</td></tr> <tr><td>55:</td><td>10.1</td><td>↗</td></tr> <tr><td>56:</td><td>9.8</td><td>←</td></tr> <tr><td>57:</td><td>6.5</td><td>↗</td></tr> <tr><td>58:</td><td>9.7</td><td>→</td></tr> <tr><td>59:</td><td>10.5x</td><td>↗</td></tr> <tr><td>60:</td><td>6.7</td><td>↗</td></tr> <tr><td colspan="2">Series</td><td>87 (1x)</td></tr> <tr><td colspan="2"></td><td>526 (1x)</td></tr> </table>	51:	9.3	↘	52:	10.1	↘	53:	9.3	↗	54:	9.0	←	55:	10.1	↗	56:	9.8	←	57:	6.5	↗	58:	9.7	→	59:	10.5x	↗	60:	6.7	↗	Series		87 (1x)			526 (1x)
41:	10.1	→																																																																									
42:	9.3	←																																																																									
43:	9.2	↖																																																																									
44:	10.2	↓																																																																									
45:	10.0	↗																																																																									
46:	9.6	↗																																																																									
47:	9.4	↘																																																																									
48:	10.4	↗																																																																									
49:	8.9	↘																																																																									
50:	9.1	→																																																																									
Series		93 (0x)																																																																									
		439 (0x)																																																																									
51:	9.3	↘																																																																									
52:	10.1	↘																																																																									
53:	9.3	↗																																																																									
54:	9.0	←																																																																									
55:	10.1	↗																																																																									
56:	9.8	←																																																																									
57:	6.5	↗																																																																									
58:	9.7	→																																																																									
59:	10.5x	↗																																																																									
60:	6.7	↗																																																																									
Series		87 (1x)																																																																									
		526 (1x)																																																																									

Relay <b>1</b>	Lane <b>29</b>	<b>ZHOU Mo</b>
-------------------	-------------------	----------------

2023 SFC Pistol Nationals	BC	SJ	MP
---------------------------	----	----	----

16.07.2023	23PN-AP-Q2	Alberta Handgun Association	
------------	------------	-----------------------------	--

Comment	Signature		
---------	-----------	--	--

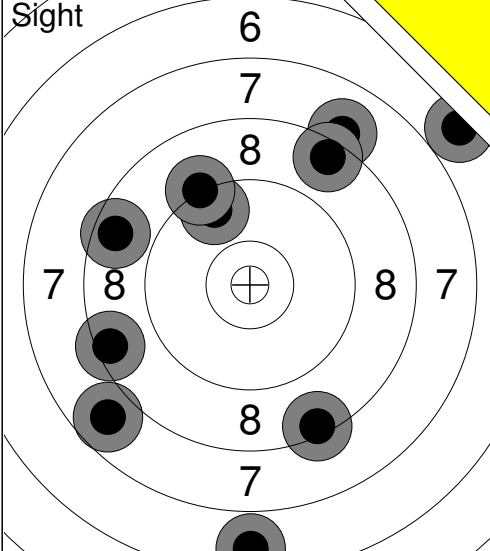
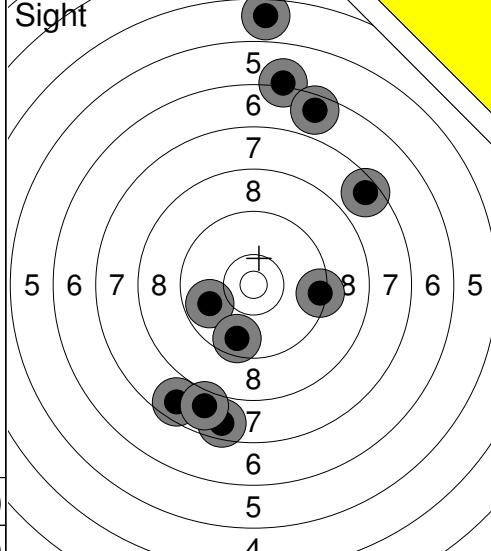
<p>Sight</p> 	<p>Sight</p> 	<p>11: 7.6 ↓</p> <p>12: 6.2 ↑</p> <p>13: 4.6 ↑</p> <p>14: 9.8 ←</p> <p>15: 7.5 ↗</p> <p>16: 9.6 ↓</p> <p>17: 7.7 ↓</p> <p>18: 7.9 ↓</p> <p>19: 9.4 →</p> <p>20: 6.6 ↑</p> <p>Series 71 (0x)</p> <p>0 (0x)</p>
---	---	---

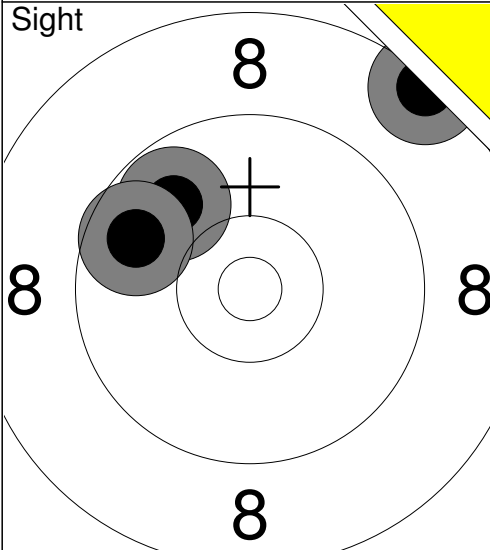
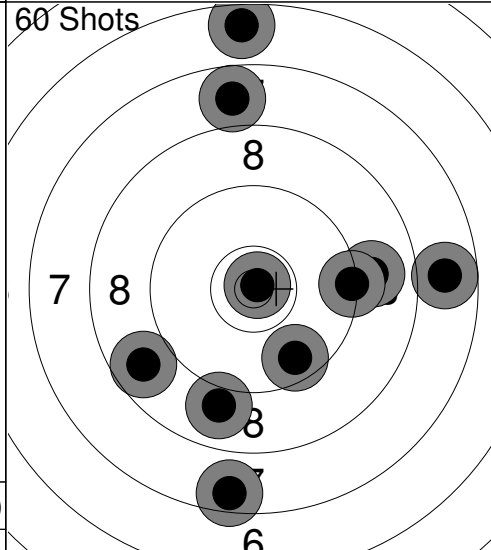
<p>Sight</p> 	<p>60 Shots</p> 	<p>21: 8.3 ↗</p> <p>22: 9.8 ↗</p> <p>23: 9.7 ←</p> <p>Series 26 (0x)</p> <p>0 (0x)</p> <p>1: 6.6 ↑</p> <p>2: 8.7 ←</p> <p>3: 9.0 →</p> <p>4: 9.3 →</p> <p>5: 10.9x ↗</p> <p>6: 7.8 →</p> <p>7: 8.9 ↓</p> <p>8: 9.6 ↓</p> <p>9: 7.5 ↓</p> <p>10: 7.8 ↑</p> <p>Series 80 (1x)</p> <p>80 (1x)</p>
--	---	--

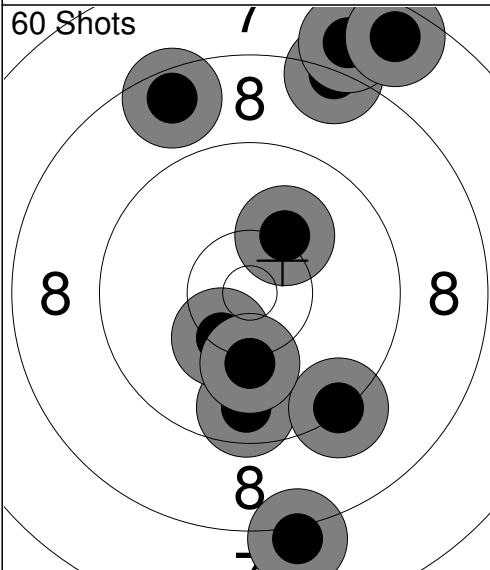
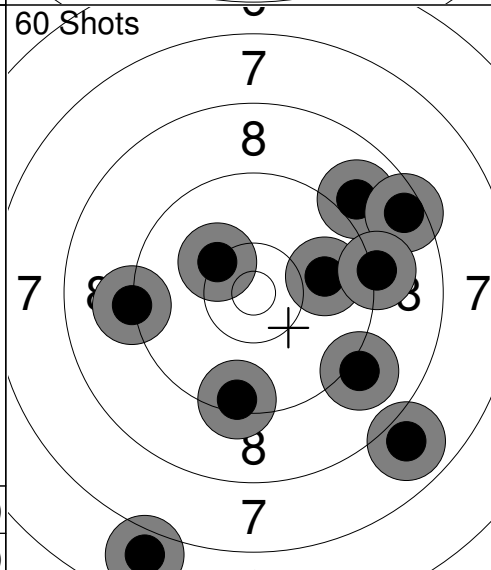
<p>60 Shots</p> 	<p>60 Shots</p> 	<p>11: 9.6 ↓</p> <p>12: 8.6 ↑</p> <p>13: 8.3 ↑</p> <p>14: 9.3 ↓</p> <p>15: 10.3 ↓</p> <p>16: 7.9 ↑</p> <p>17: 10.1 ↓</p> <p>18: 8.1 ↓</p> <p>19: 7.6 ↑</p> <p>20: 10.2 ↑</p> <p>Series 86 (0x)</p> <p>166 (1x)</p> <p>21: 9.9 →</p> <p>22: 9.0 ↗</p> <p>23: 8.5 ↗</p> <p>24: 9.2 →</p> <p>25: 10.3 ↖</p> <p>26: 9.1 ↘</p> <p>27: 9.4 ↓</p> <p>28: 9.2 ←</p> <p>29: 6.9 ↓</p> <p>30: 7.9 ↘</p> <p>Series 85 (0x)</p> <p>251 (1x)</p>
--	--	---



Relay <b>1</b>	Lane <b>30</b>	<b>HAGLUND Wayne</b>			
-------------------	-------------------	----------------------	--	--	--

2023 SFC Pistol Nationals			AB	SP	MP
---------------------------	--	--	----	----	----

16.07.2023	23PN-AP-Q2	Alberta Handgun Association
------------	------------	-----------------------------

Comment	Signature
---------	-----------

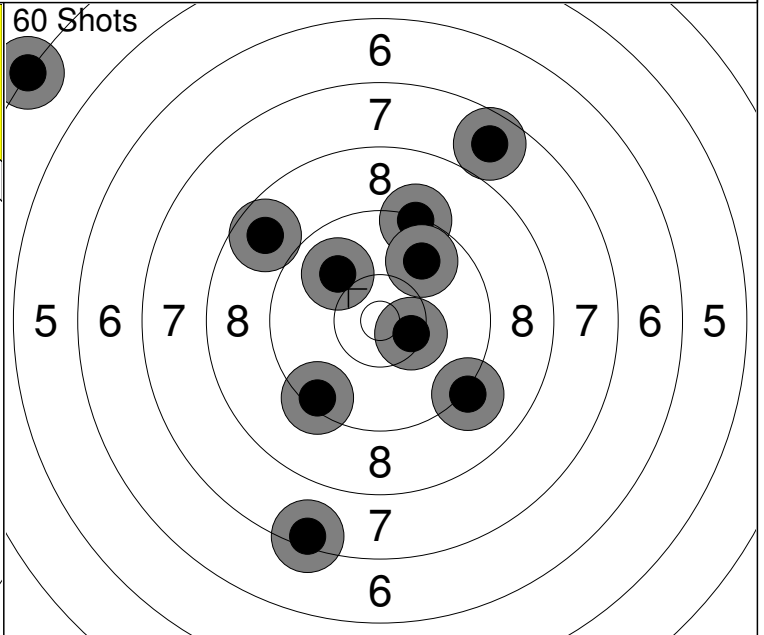
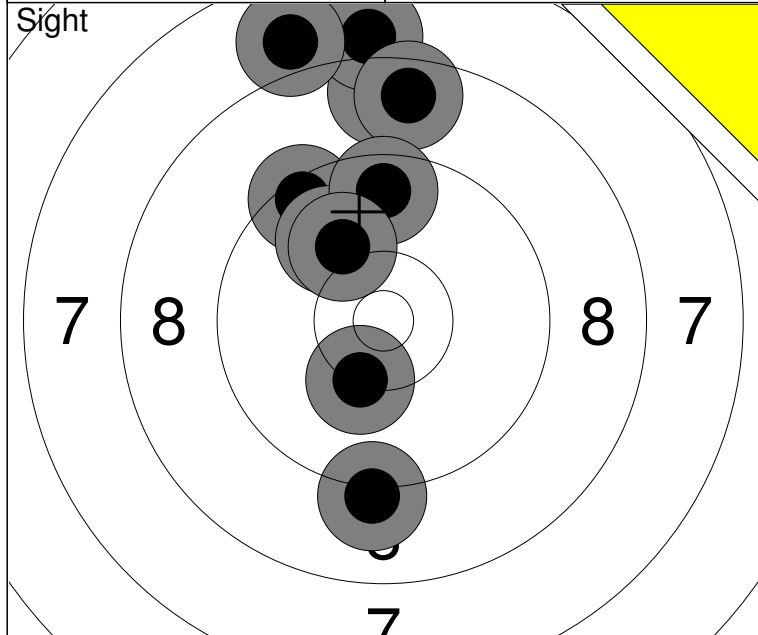

1: 9.4 ↖	6: 8.6 ↑	Series	87 (0x)
2: 8.6 ↑	7: 7.9 ↑		
3: 9.1 ↓	8: 9.6 ↑	0 (0x)	
4: 8.0 ↑	9: 10.3 ↓		
5: 9.9 ↖	10: 10.1 ↖		

1: 8.7 ↖	6: 9.3 ↑	Series	82 (1x)
2: 7.7 ↗	7: 9.2 ↘		
3: 10.4x ↘	8: 4.2 ↖	82 (1x)	
4: 7.4 ↓	9: 9.4 ↘		
5: 10.0 ↖	10: 9.8 ↗		

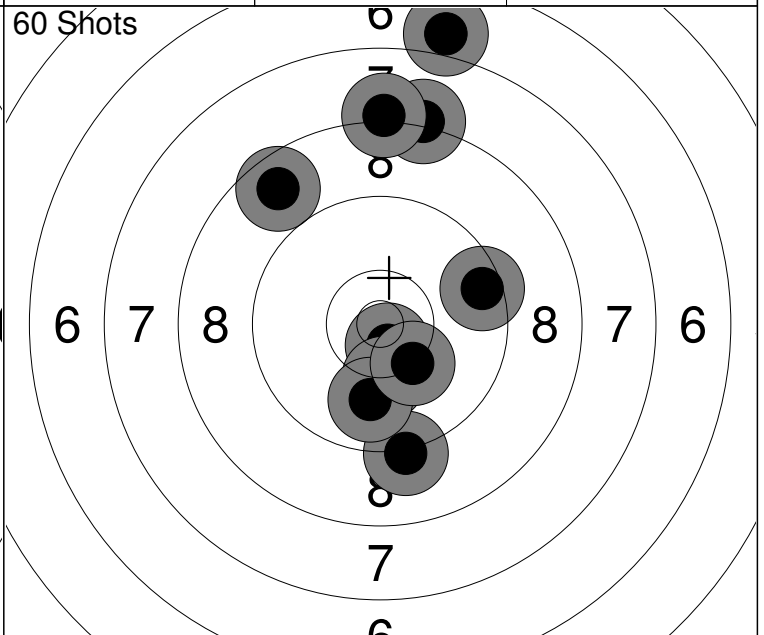
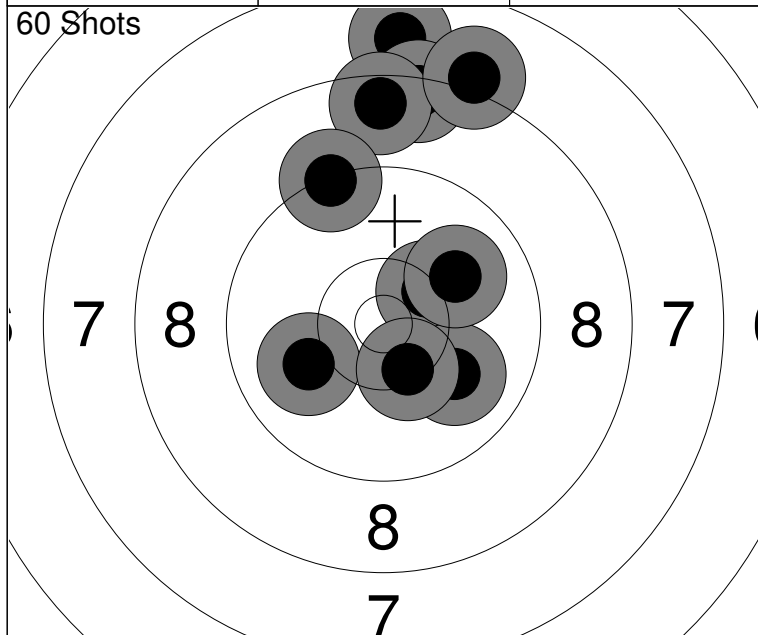

11: 10.0 ↙	16: 9.3 ↑	Series	90 (1x)
12: 7.8 ↑	17: 8.1 ↑		
13: 8.4 ↑	18: 10.0 ↘	172 (2x)	
14: 8.5 ↑	19: 10.0 ↗		
15: 10.4 ↗	20: 10.4x ↓		

21: 10.6x ↓	26: 10.3 ↘	Series	87 (1x)
22: 9.2 ↓	27: 9.5 →		
23: 10.2 ↓	28: 8.2 ↑	259 (3x)	
24: 8.7 ↖	29: 6.9 ↑		
25: 9.9 ↓	30: 8.1 ↑		