

Relay 1	Lane 3	<h1>NORMAN Rex</h1>
-------------------	------------------	---------------------

2023 SFC Pistol Nationals SK	JR	MP
------------------------------	----	----

13.07.2023	23PNHRF1S1	Alberta Handgun Association
------------	------------	-----------------------------

Comment	Signature
---------	-----------

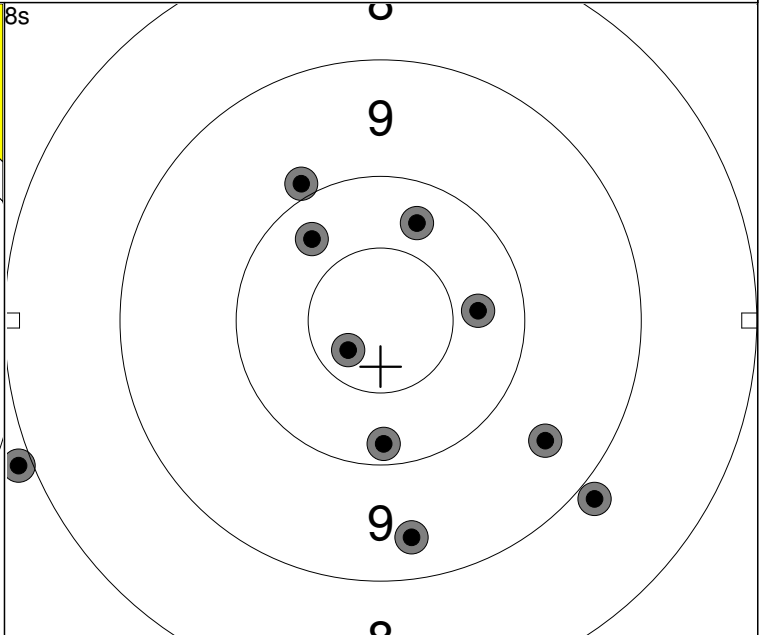
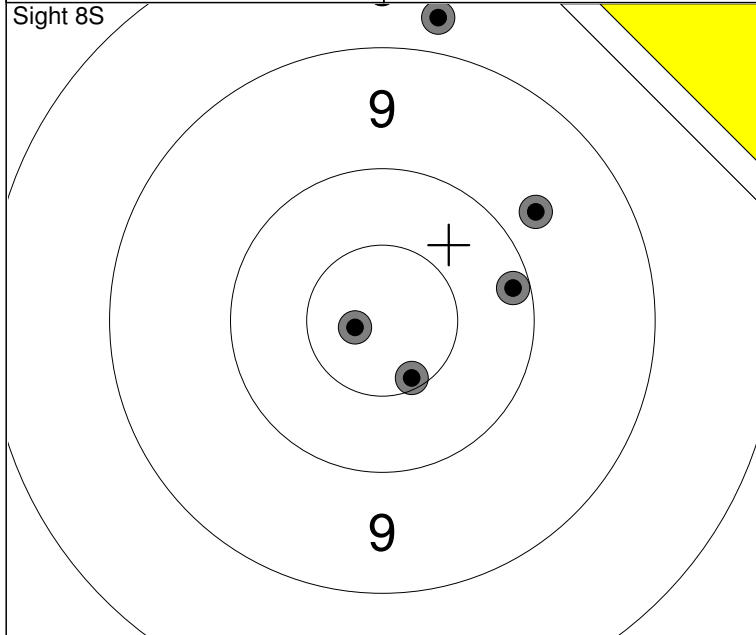

1: 2.40s 9.7 ↗
2: 3.63s 8.7 ↑
3: 4.75s 10.8x ←
4: 5.84s 10.5x ↓
5: 7.17s 10.1 →

Series	47 (2x)
	0 (0x)

1: 2.45s 9.9 ↗
2: 3.73s 10.2 ↗
3: 4.90s 10.3 ↑
4: 5.88s 10.3 →
5: 6.74s 9.4 ↓

1: 2.13s 10.7x ↙
2: 3.24s 7.9 ←
3: 4.10s 8.9 ↘
4: 5.09s 10.1 ↓
5: 6.10s 9.5 ↘

Series	92 (1x)
	92 (1x)

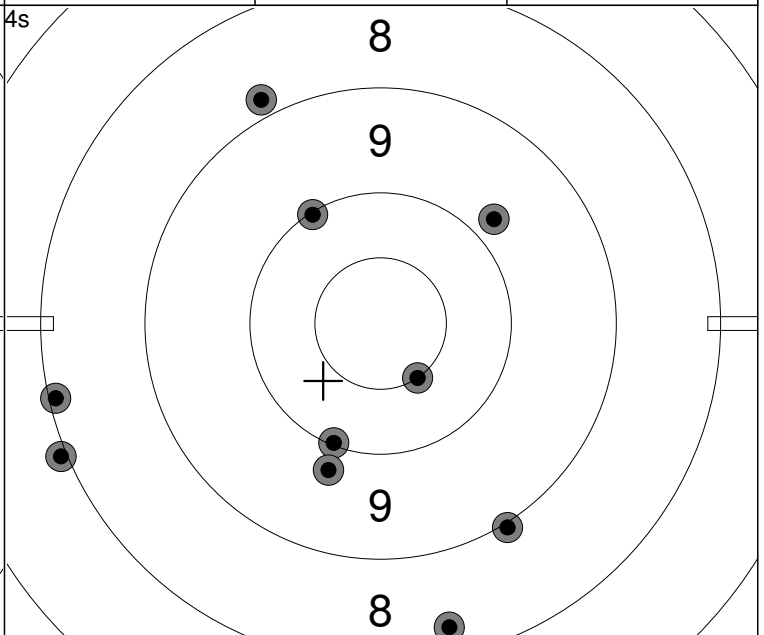
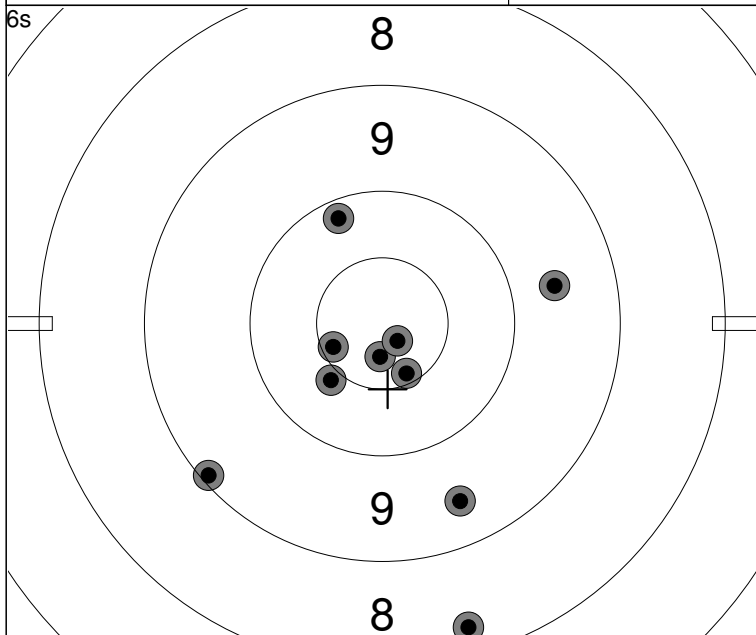

1: 2.19s 9.6 →
2: 2.96s 10.7x ↓
3: 3.66s 10.4 ↙
4: 4.40s 10.6x ↓
5: 5.15s 9.1 ↙

1: 2.27s 10.6x ←
2: 2.98s 10.1 ↗
3: 3.80s 9.4 ↓
4: 4.51s 8.3 ↓
5: 5.27s 10.8x ↓

Series	95 (4x)
	187 (5x)

1: 1.69s 10.0 ↗
2: 2.19s 10.0 ↓
3: 2.67s 8.3 ↓
4: 3.13s 9.8 ↗
5: 3.68s 8.1 ←

1: 1.56s 8.0 ←
2: 2.41s 10.5x ↓
3: 3.04s 9.0 ↘
4: 3.61s 8.8 ↗
5: 3.98s 9.8 ↓

Series	89 (1x)
	276 (6x)

Relay 1	Lane 8	<h1>NORMAN Seth</h1>
-------------------	------------------	----------------------

2023 SFC Pistol Nationals	SK	IJ	MP
---------------------------	----	----	----

13.07.2023	23PNHRF1S1	Alberta Handgun Association
------------	------------	-----------------------------

Comment	Signature
---------	-----------

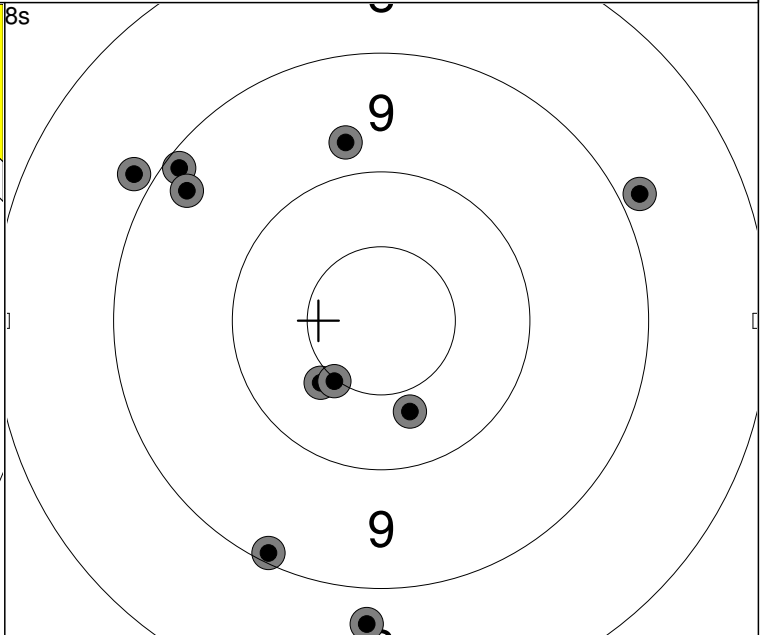
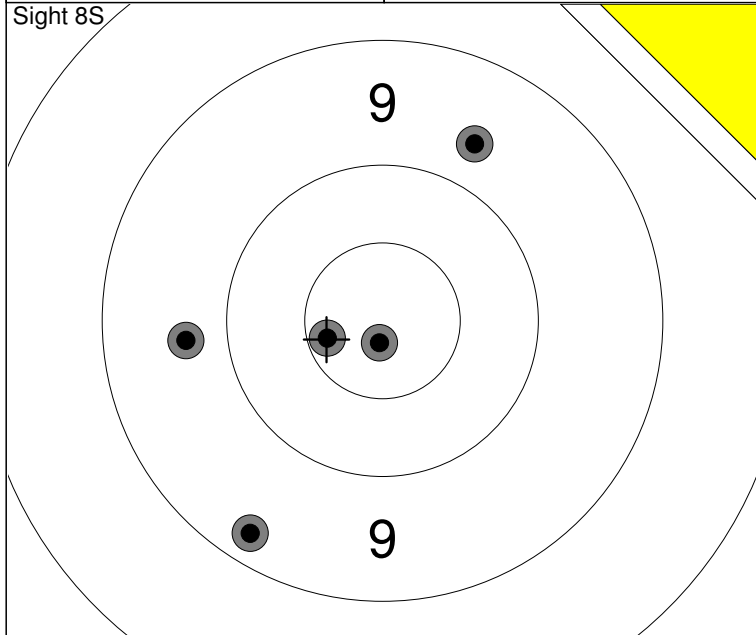

1: 2.26s 10.6x ←
2: 3.22s 10.8x ↓
3: 4.36s 9.7 ←
4: 5.34s 9.3 ↘
5: 6.26s 9.7 ↗

Series	47 (2x)
Series	0 (0x)

1: 2.15s 8.7 ↓
2: 3.05s 10.3 ↓
3: 3.99s 9.7 ↑
4: 5.22s 10.4 ↘
5: 6.45s 8.9 ←

1: 2.18s 9.1 ↖
2: 3.12s 9.1 ↓
3: 4.47s 9.3 ↖
4: 5.73s 8.8 →
5: 6.93s 10.5x ↘

Series	90 (1x)
Series	90 (1x)

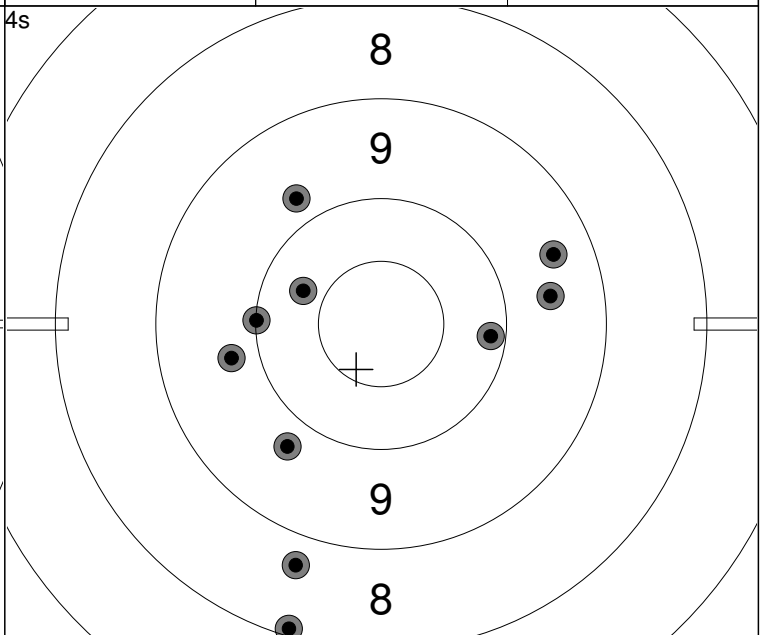
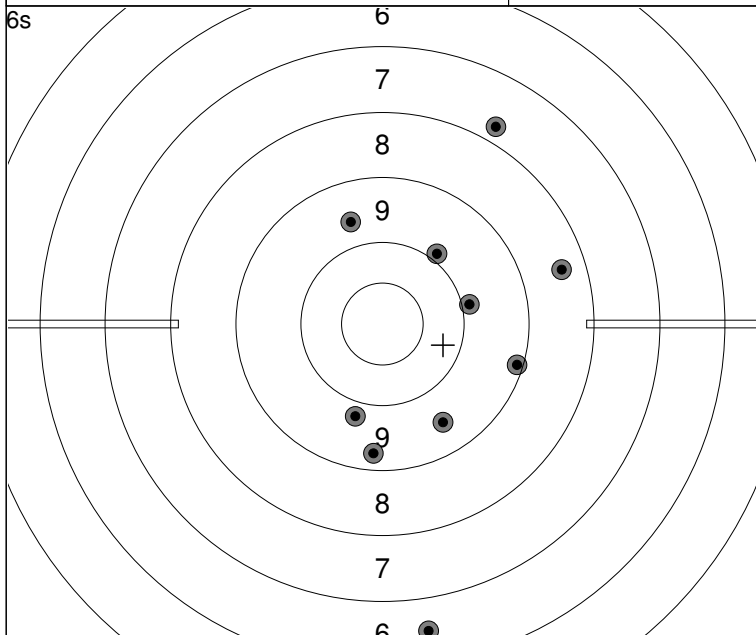

1: 2.31s 7.8 ↗
2: 3.08s 9.9 ↗
3: 4.00s 9.3 ↓
4: 4.77s 9.1 →
5: 5.49s 9.5 ↘

1: 1.87s 6.5 ↓
2: 2.70s 9.8 ↓
3: 3.58s 9.6 ↑
4: 4.48s 8.4 →
5: 5.36s 9.9 →

Series	84 (0x)
Series	174 (1x)

1: 1.54s 9.8 ↖
2: 2.11s 10.1 →
3: 2.64s 10.0 ←
4: 3.21s 9.6 →
5: 3.75s 9.4 →

1: 1.57s 10.3 ↖
2: 2.12s 9.7 ←
3: 2.77s 8.7 ↓
4: 3.39s 9.7 ↘
5: 3.99s 8.1 ↓

Series	91 (0x)
Series	265 (1x)

Relay 1	Lane 18	ZHANG Zhuang
-------------------	-------------------	---------------------

2023 SFC Pistol Nationals	BC	EX	MP
---------------------------	----	----	----

13.07.2023	23PNHRF1S1	Alberta Handgun Association
------------	------------	-----------------------------

Comment	Signature
---------	-----------

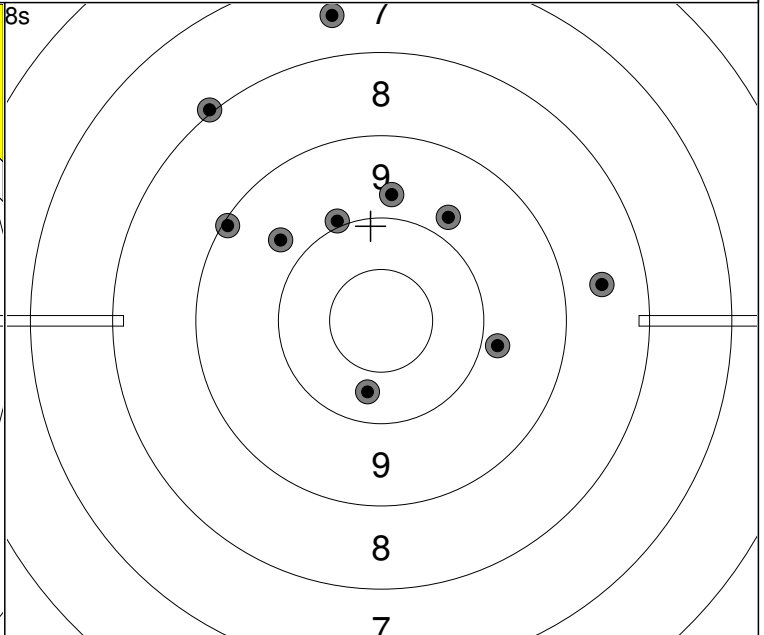
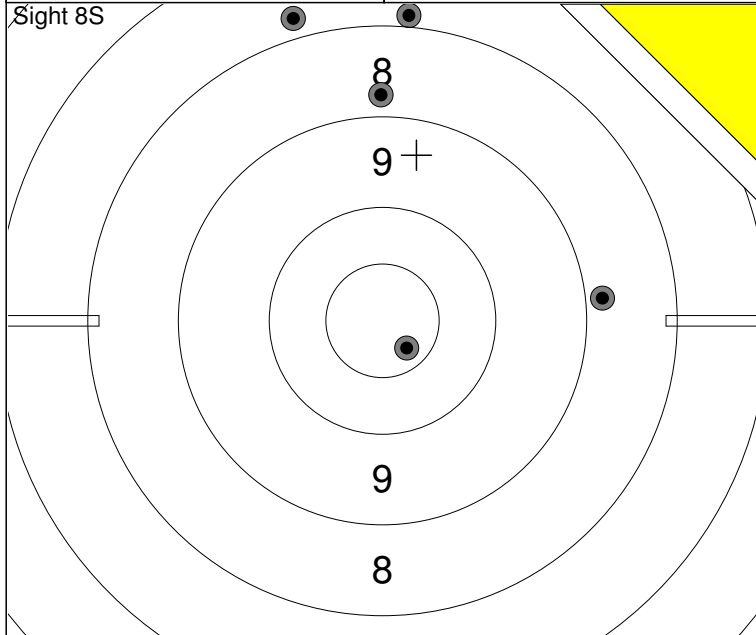

5: 2.17s	7.9	↑
4: 3.58s	10.6x	↘
3: 4.82s	7.8	↑
2: 6.09s	8.8	→
1: 7.07s	8.8	↑

Series	40 (1x)
	0 (0x)

5: 2.14s	9.8	↗
4: 3.43s	9.7	↖
3: 4.60s	9.8	→
2: 5.69s	9.7	↑
1: 6.99s	9.9	↖

5: 2.61s	8.0	↖
4: 4.03s	9.1	↖
3: 4.80s	7.5	↑
2: 5.71s	10.3	↓
1: 6.82s	8.6	→

Series	87 (0x)
	87 (0x)

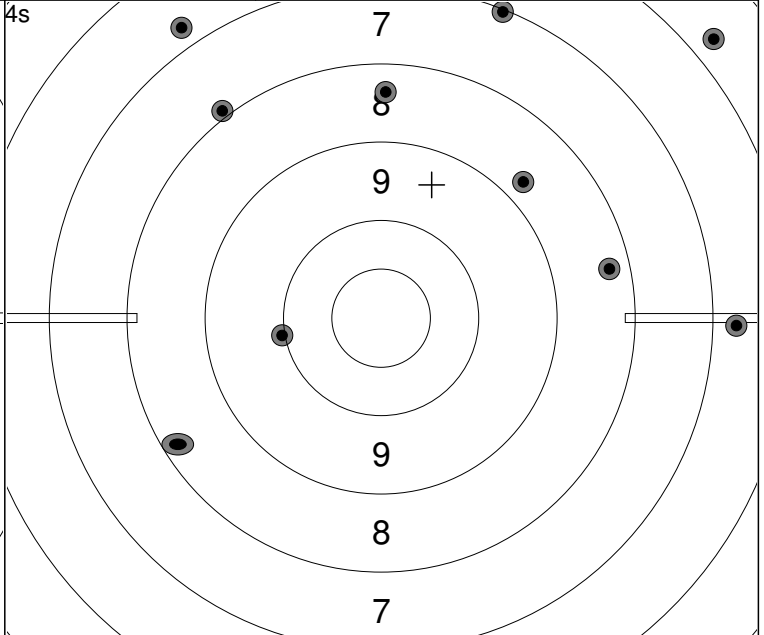
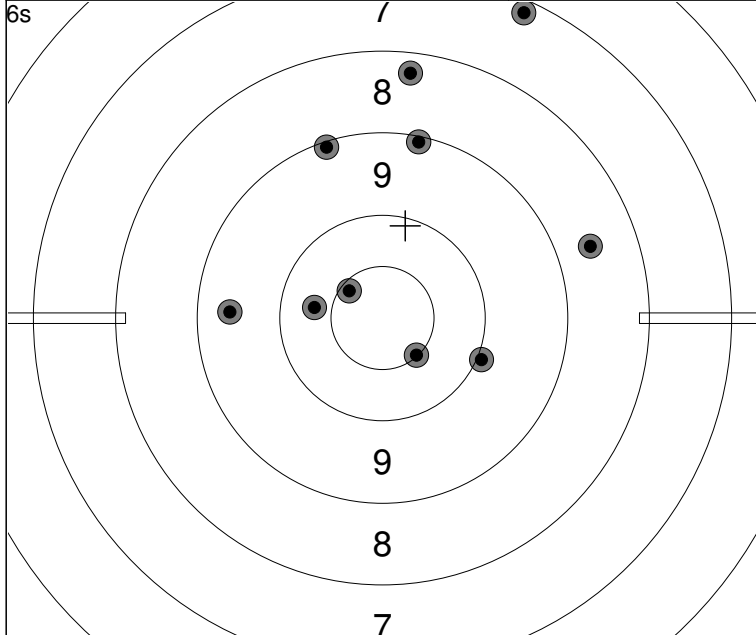

5: 1.81s	9.1	↑
4: 2.76s	10.0	↘
3: 3.46s	9.1	↑
2: 4.27s	9.4	←
1: 5.27s	7.2	↖

5: 1.77s	10.3	←
4: 2.69s	10.5x	↘
3: 3.55s	8.3	↑
2: 4.56s	10.6x	↖
1: 5.33s	8.6	→

Series	90 (2x)
	177 (2x)

5: 1.56s	5.7	↗
4: 2.35s	8.3	→
3: 2.94s	10.0	←
2: 3.40s	7.1	↑
1: 4.10s	8.4	↑

5: 1.54s	6.7	→
4: 2.33s	6.8	↖
3: 3.07s	7.9	↖
2: 3.64s	8.8	↖
1: 0.09s	7.4	↖

Series	65 (0x)
	242 (2x)

Relay 1	Lane 23	CHEN Wei ping
-------------------	-------------------	----------------------

2023 SFC Pistol Nationals	BC	VT	MP
---------------------------	----	----	----

13.07.2023	23PNHRF1S1	Alberta Handgun Association
------------	------------	-----------------------------

Comment	Signature
---------	-----------

DSQ	Frame Hits
-----	------------

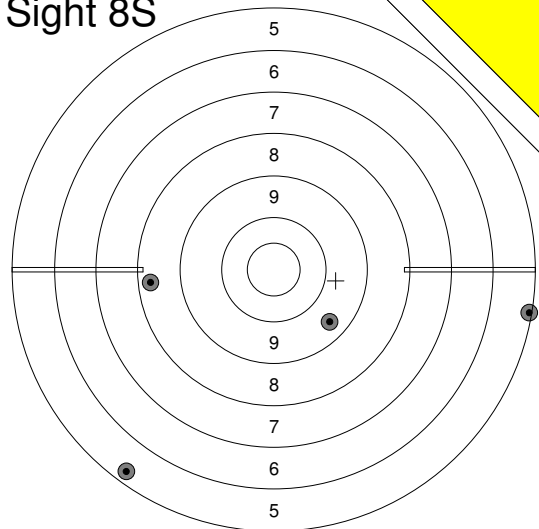
Sight 8S 	1:	2.75s	5.1	→
	2:	4.01s	5.3	↙
	3:	5.45s	9.4	↘
	4:	7.12s	8.3	←
	5:	0.09s	↔	
Series			27 (0x)	
			0 (0x)	

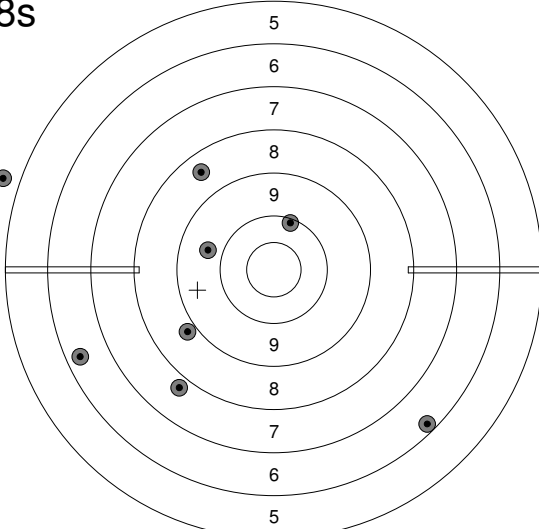
8s 	1:	2.02s	8.8	↙
	2:	3.12s	9.7	←
	3:	3.90s	8.4	↗
	5:	6.42s	0.0	←
	4:		--	
	1:	1.97s	↔	
	2:	2.77s	6.3	←
	3:	4.31s	7.7	↙
	4:	5.27s	10.1	↗
	5:	6.14s	6.2	↘
Series			54 (0x)	
			54 (0x)	

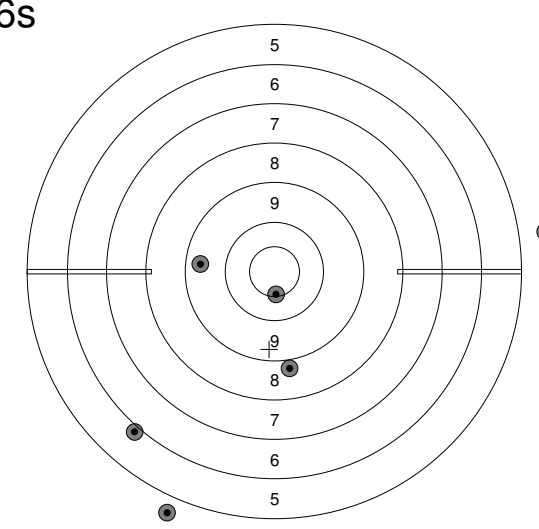
6s 	2:	1.85s	8.8	↘
	3:	2.69s	↔	
	4:	2.69s	0.0	→
	5:	4.32s	9.4	←
	1:		--	
	2:	2.03s	5.9	↙
	3:	2.83s	0.0	↙
	4:	3.69s	10.5x	↘
	1:		--	
Series			32 (1x)	
			86 (1x)	

Relay 2	Lane 3	KINDBOM Matt
-------------------	------------------	---------------------

2023 SFC Pistol Nationals	ON	EX	MP
---------------------------	----	----	----

13.07.2023	23PNHRF1S1	Alberta Handgun Association
------------	------------	-----------------------------

Comment	Signature
---------	-----------

DSQ	Frame Hits
-----	------------

Sight 8S 	11.98s 9.7 ←	8s 	12.24s 8.7 ←
	23.27s 9.8 →		23.31s 9.4 ↖
	34.42s 10.3 →		34.19s 10.1 ←
	45.57s 8.5 ↙		45.27s 8.8 ←
	56.74s 5.9 ←		56.53s 7.9 ←
			12.63s 6.9 ↗
			23.63s 10.2 ↘
			34.60s 10.2 ↗
			45.73s 10.0 ↓
			56.89s 10.7x ↖
	Series 41 (0x)		Series 88 (1x)
	0 (0x)		88 (1x)

6s 	22.90s ☒	6s 	5: --
	33.64s 7.7 ←		12.10s 6.8 ↗
	44.33s 9.6 →		55.49s 0.0 ↗
	55.12s 10.2 ←		4: --
	2: --		
	22.77s 10.7x →		
	33.74s 6.6 ←		
	44.65s 7.9 ↗		
	Series 49 (1x)		Series 6 (0x)
	137 (2x)		143 (2x)

Sh.off 6S 	23.09s 10.4x ←		
	33.88s 8.8 ↑		
	Series 18 (1x)		
	143 (2x)		

Relay 2	Lane 8	PADDA Davinderjit (dave)
-------------------	------------------	---------------------------------

2023 SFC Pistol Nationals	BC	EX	MP
---------------------------	----	----	----

13.07.2023	23PNHRF1S1	Alberta Handgun Association
------------	------------	-----------------------------

Comment	Signature
---------	-----------

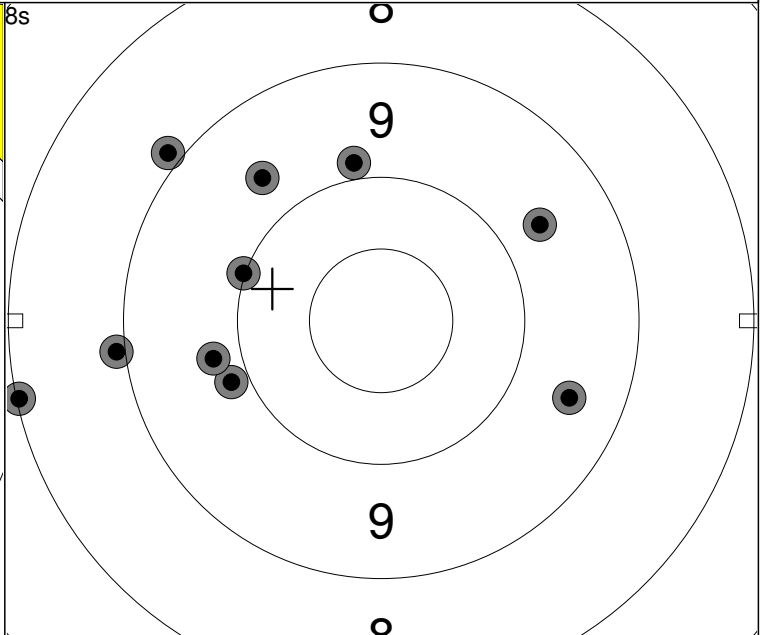
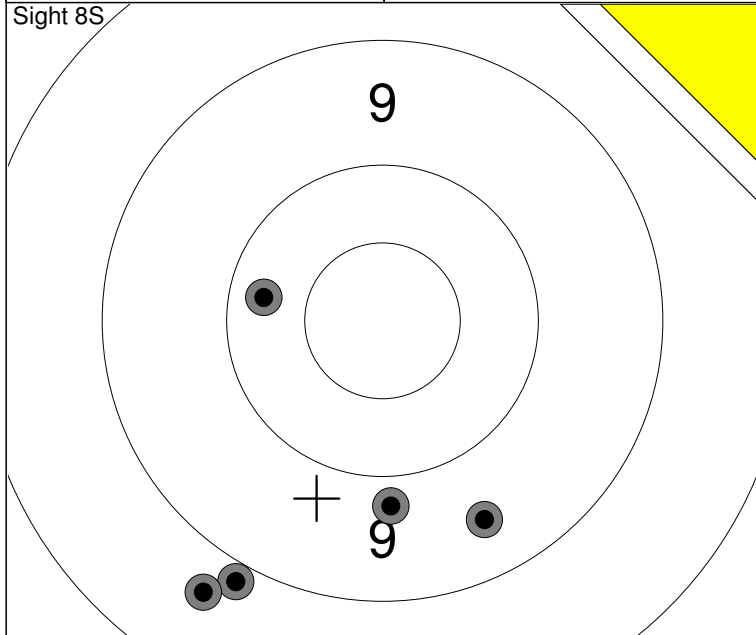

1: 2.30s	8.9	↘
2: 3.45s	8.7	↘
3: 4.44s	10.2	←
4: 5.39s	9.5	↘
5: 6.77s	9.8	↓

Series	44 (0x)
	0 (0x)

1: 2.80s	8.0	←
2: 3.81s	8.9	←
3: 4.90s	9.9	↑
4: 5.81s	9.5	→
5: 7.09s	9.9	←

1: 2.39s	10.0	←
2: 3.82s	9.8	←
3: 5.03s	9.7	↗
4: 6.25s	8.9	↗
5: 7.37s	9.7	↗

Series	88 (0x)
	88 (0x)

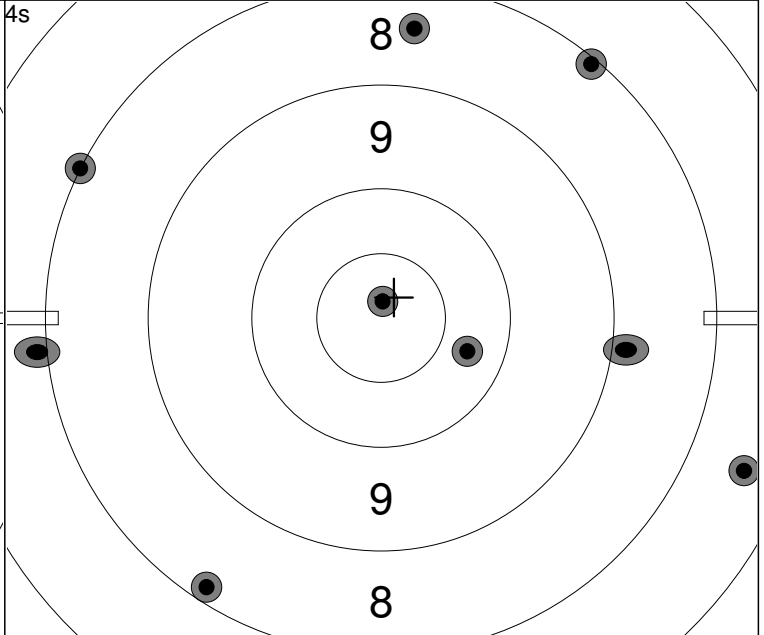
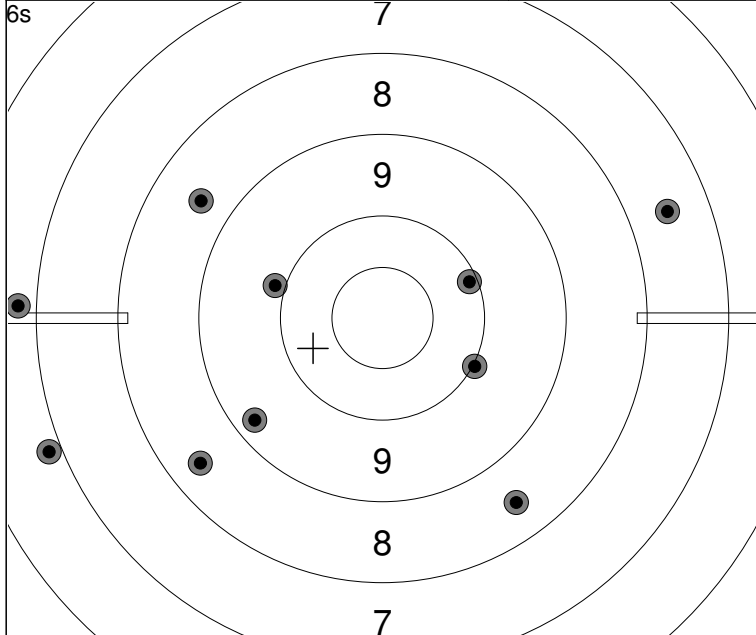

1: 2.04s	8.5	↘
2: 3.00s	6.8	←
3: 3.75s	7.5	→
4: 4.52s	9.9	←
5: 5.28s	9.3	↙

1: 2.26s	10.1	→
2: 3.18s	10.0	→
3: 3.99s	8.4	↙
4: 4.88s	6.9	←
5: 5.58s	8.6	↙

Series	81 (0x)
	169 (0x)

1: 1.98s	8.2	↘
2: 2.62s	8.4	↑
3: 3.29s	8.0	↙
4: 4.02s	10.8x	↑
5: 0.40s	↕	

1: 1.98s	7.5	→
2: 2.65s	↕	
3: 3.52s	10.3	→
4: 4.08s	8.1	↗
5: 0.29s	↕	

Series	59 (1x)
	228 (1x)

Relay 2	Lane 18	EK Nils
-------------------	-------------------	----------------

2023 SFC Pistol Nationals	QC	EX	MP
---------------------------	----	----	----

13.07.2023	23PNHRF1S1	Alberta Handgun Association
------------	------------	-----------------------------

Comment	Signature
---------	-----------

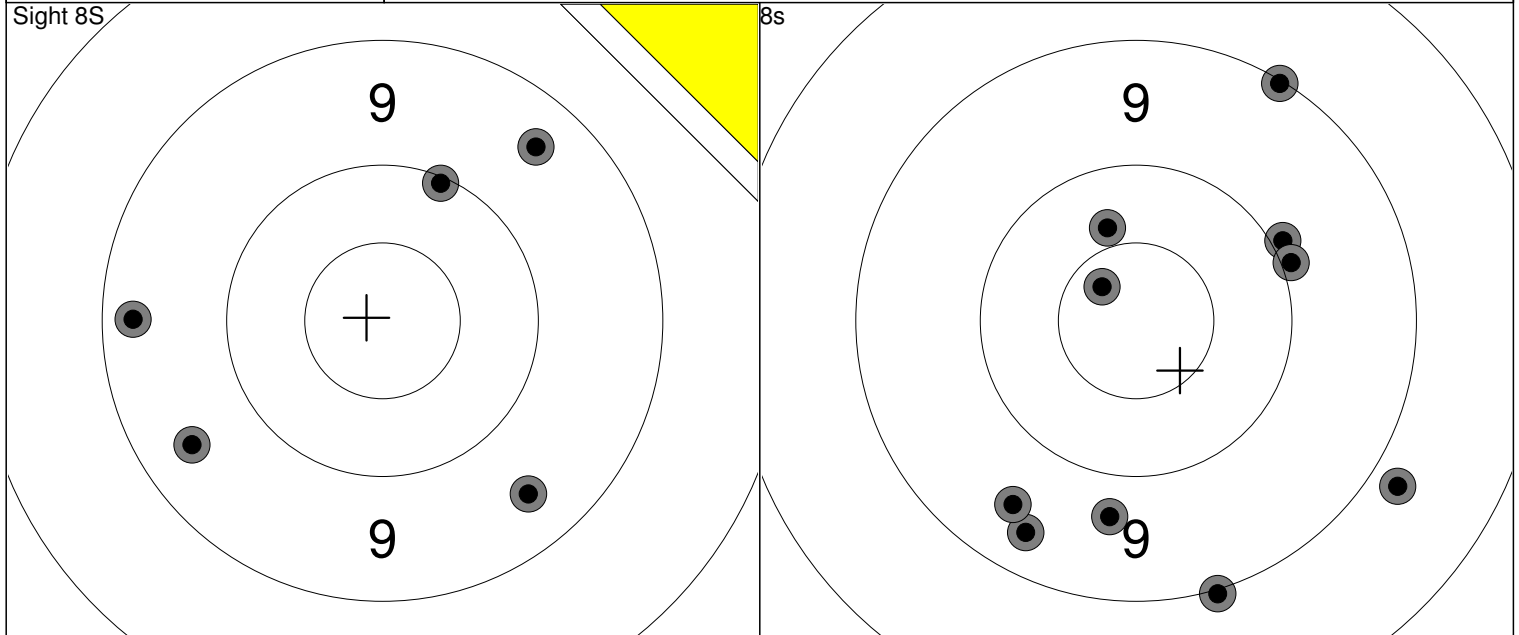

1: 2.63s 9.5 ↘	Series 46 (0x)	1: 2.41s 9.4 ↙	1: 2.51s 9.9 →	Series 91 (1x)
2: 3.81s 9.4 ↗		2: 3.62s 9.0 ↓	2: 3.50s 10.4 ↗	
3: 4.98s 9.3 ←		3: 4.87s 9.7 ↓	3: 4.72s 10.7x ↗	
4: 6.15s 9.4 ↙		4: 6.07s 9.9 ↗	4: 5.78s 9.0 ↗	
5: 7.42s 10.0 ↗		5: 7.19s 9.5 ↙	5: 6.97s 8.8 ↘	
	0 (0x)			91 (1x)

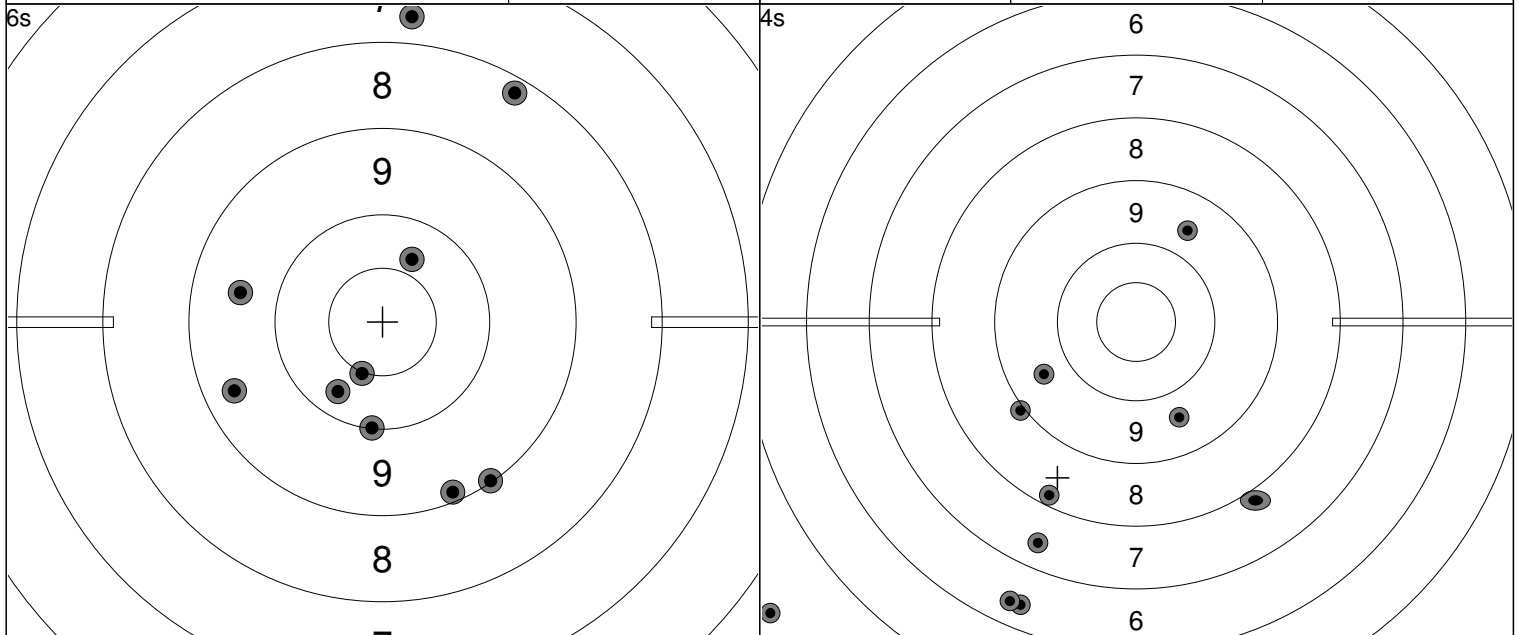

1: 2.00s 9.1 ↘	1: 1.80s 9.4 ←	Series 91 (1x)	1: 1.76s 9.6 ←	1: 2.02s 6.4 ↓	Series 62 (0x)
2: 2.87s 7.7 ↑	2: 2.88s 10.2 ↓		2: 2.25s 8.2 ↓	2: 2.76s 8.9 ↙	
3: 3.74s 10.3 ↗	3: 3.92s 8.2 ↗		3: 2.76s 7.4 ↓	3: 3.25s 9.6 ↗	
4: 4.71s 10.5x ↓	4: 4.80s 9.6 ←		4: 3.62s 9.6 ↓	4: 3.77s 6.4 ↓	
5: 5.58s 9.0 ↘	5: 5.65s 10.0 ↓		5: 4.12s 0.0 ←	5: 0.32s 7.4 ↘	
		182 (2x)			244 (2x)

Relay 2	Lane 23	SANDALL Jim
-------------------	-------------------	--------------------

2023 SFC Pistol Nationals	MB	EX	MP
---------------------------	----	----	----

13.07.2023	23PNHRF1S1	Alberta Handgun Association
------------	------------	-----------------------------

Comment	Signature
---------	-----------

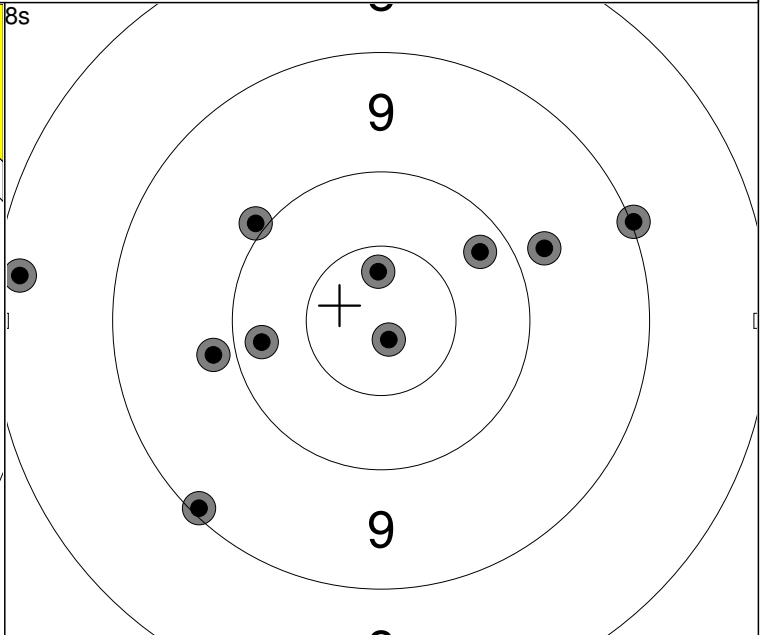
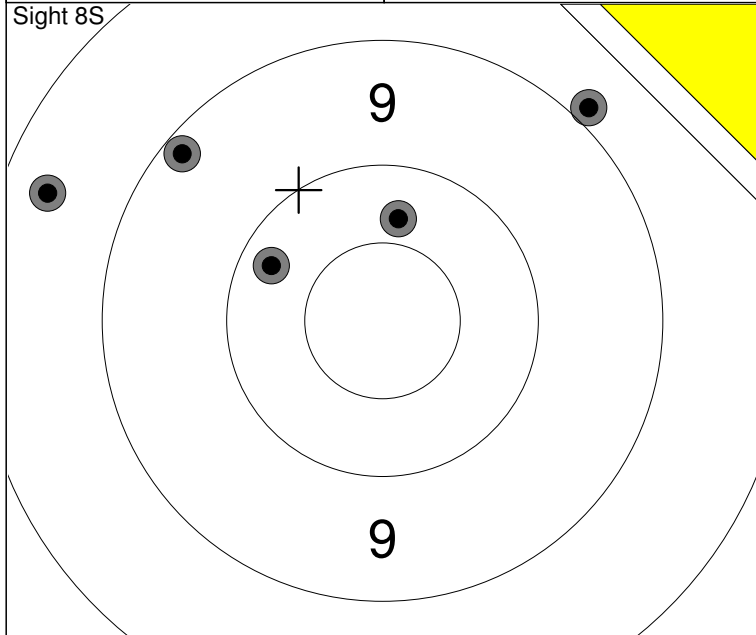

1: 2.81s 10.3	↑
2: 3.82s 9.2	↖
3: 4.83s 10.2	↙
4: 5.80s 8.4	↙
5: 6.83s 8.9	↗

Series	45 (0x)
Series	0 (0x)

1: 3.34s 10.8x	↓
2: 4.27s 9.9	↖
3: 5.04s 10.6x	↑
4: 5.81s 9.0	→
5: 6.78s 10.2	←

1: 3.07s 9.8	→
2: 4.18s 9.1	↙
3: 5.11s 9.8	←
4: 6.11s 8.2	←
5: 7.13s 10.2	↗

Series	93 (2x)
Series	93 (2x)

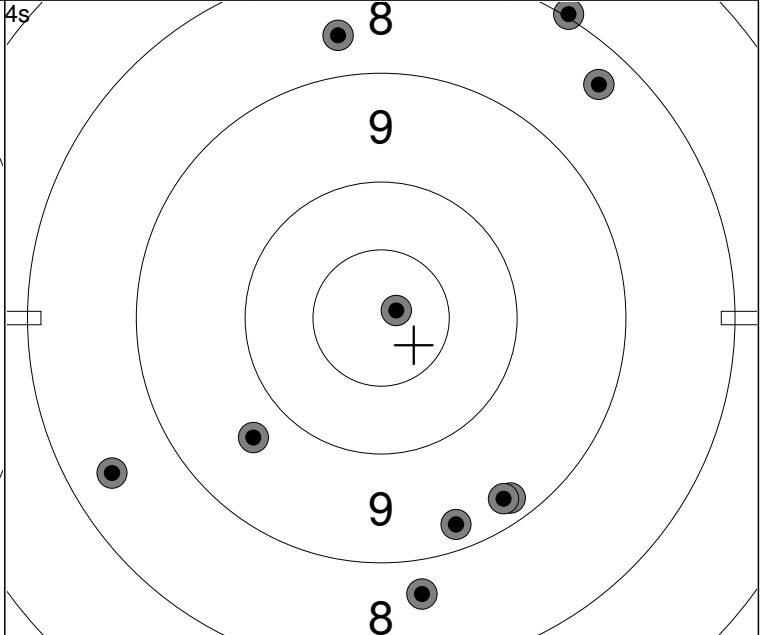
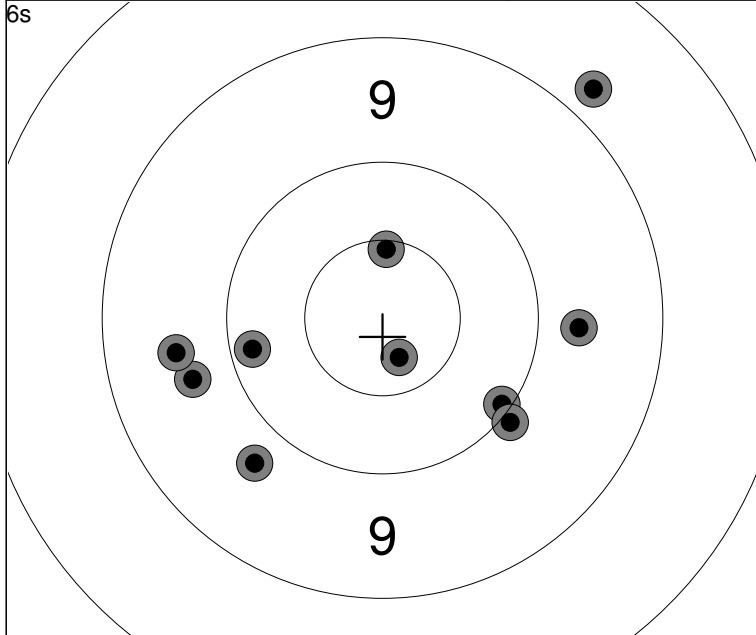

1: 2.46s 9.7	→
2: 3.24s 10.1	←
3: 3.90s 9.7	←
4: 4.50s 9.6	←
5: 5.28s 9.7	↙

1: 2.21s 10.1	↘
2: 3.13s 8.8	↗
3: 3.80s 10.7x	↓
4: 4.55s 9.9	↘
5: 5.21s 10.5x	↑

Series	93 (2x)
Series	186 (4x)

1: 1.57s 8.7	↓
2: 2.09s 8.4	↙
3: 2.56s 8.0	↗
4: 3.05s 8.3	↗
5: 3.52s 8.6	↑

1: 2.07s 9.2	↘
2: 2.66s 9.3	↘
3: 3.17s 9.7	↙
4: 3.67s 9.3	↓
5: 4.13s 10.8x	↗

Series	86 (1x)
Series	272 (5x)

Relay 3	Lane 3	<h1>PYLE Thomas</h1>
-------------------	------------------	----------------------

2023 SFC Pistol Nationals	BC	MA	MP
---------------------------	----	----	----

13.07.2023	23PNHRF1S1	Alberta Handgun Association
------------	------------	-----------------------------

Comment	Signature
---------	-----------

	2pt. Decuction Frame hits
--	---------------------------

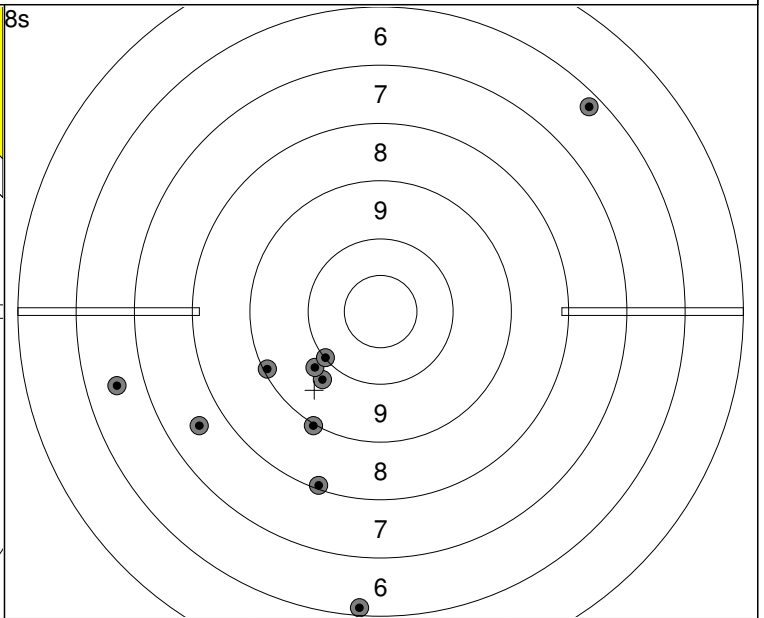
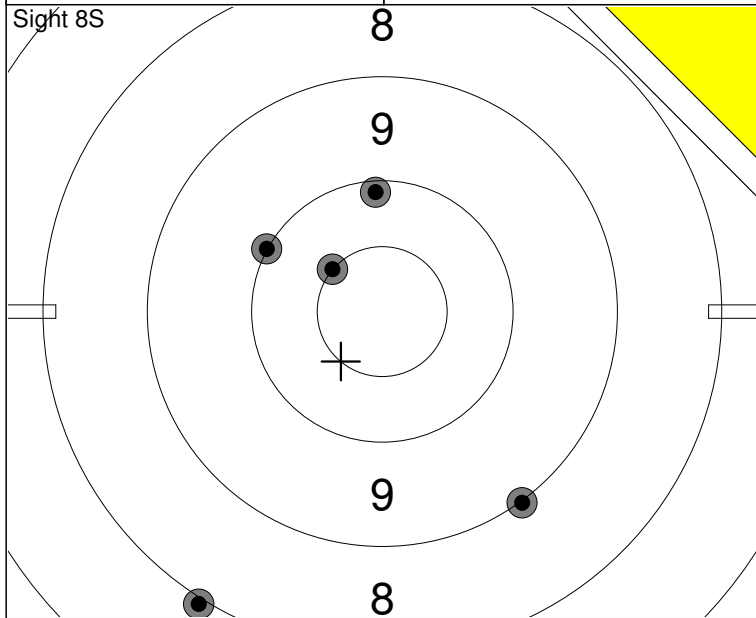

1: 2.04s 10.5x ↗
2: 2.96s 10.0 ↗
3: 4.03s 10.1 ↑
4: 5.07s 9.0 ↓
5: 6.08s 8.0 ↘

Series 47 (1x)
0 (0x)

1: 2.30s 8.1 ↓
2: 3.12s 9.7 ↓
3: 4.09s 9.8 ↘
4: 5.13s 10.0 ↘
5: 5.98s 9.1 ↙

1: 2.04s 6.2 ↓
2: 3.09s 6.2 ↗
3: 3.88s 9.0 ↓
4: 4.74s 7.6 ↙
5: 5.79s 6.5 ←

Series 79 (0x)
79 (0x)

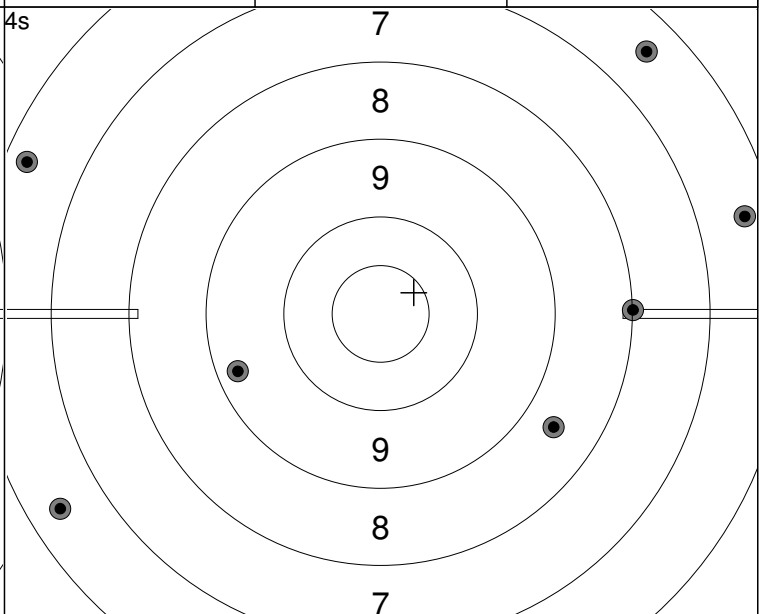
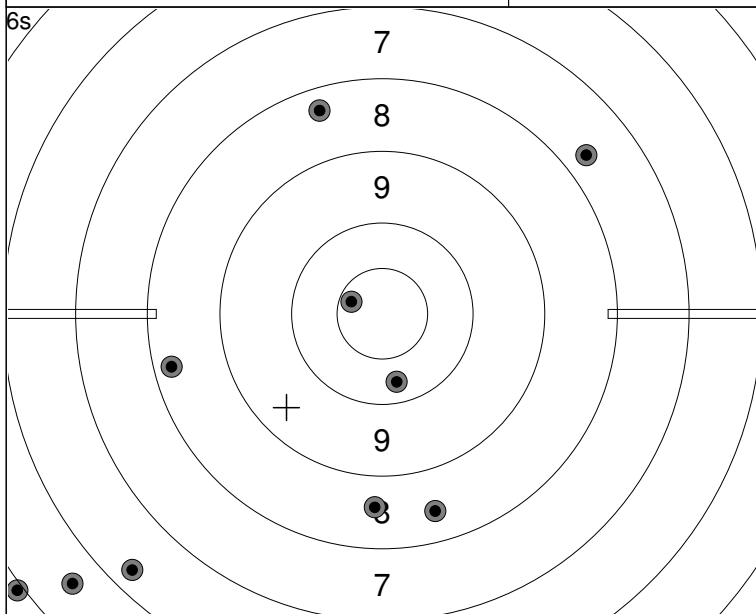

1: 2.09s 10.2 ↓
2: 2.78s 0.0 ↙
3: 3.54s 8.4 ↓
4: 4.37s 8.6 ↓
5: 5.17s 7.7 ↗

1: 1.81s 10.6x ↖
2: 2.67s 8.3 ←
3: 3.49s 5.6 ↙
4: 4.35s 6.3 ↙
5: 5.16s 8.3 ↑

Series 70 (1x)
149 (1x)

1: 1.61s 6.4 →
2: 2.14s 6.4 ↗
3: 2.61s 6.4 ↙
4: 3.08s 8.0 →
5: 3.46s 8.6 ↘

1: 1.50s 6.3 ↖
2: 2.00s 9.3 ←
1: 0.00s 6.0
5: 3.49s ☒

Series 55 (0x)
204 (1x)

Relay 3	Lane 8	WICK Werner
-------------------	------------------	--------------------

2023 SFC Pistol Nationals	AB	MA	MP
---------------------------	----	----	----

13.07.2023	23PNHRF1S1	Alberta Handgun Association
------------	------------	-----------------------------

Comment	Signature
---------	-----------

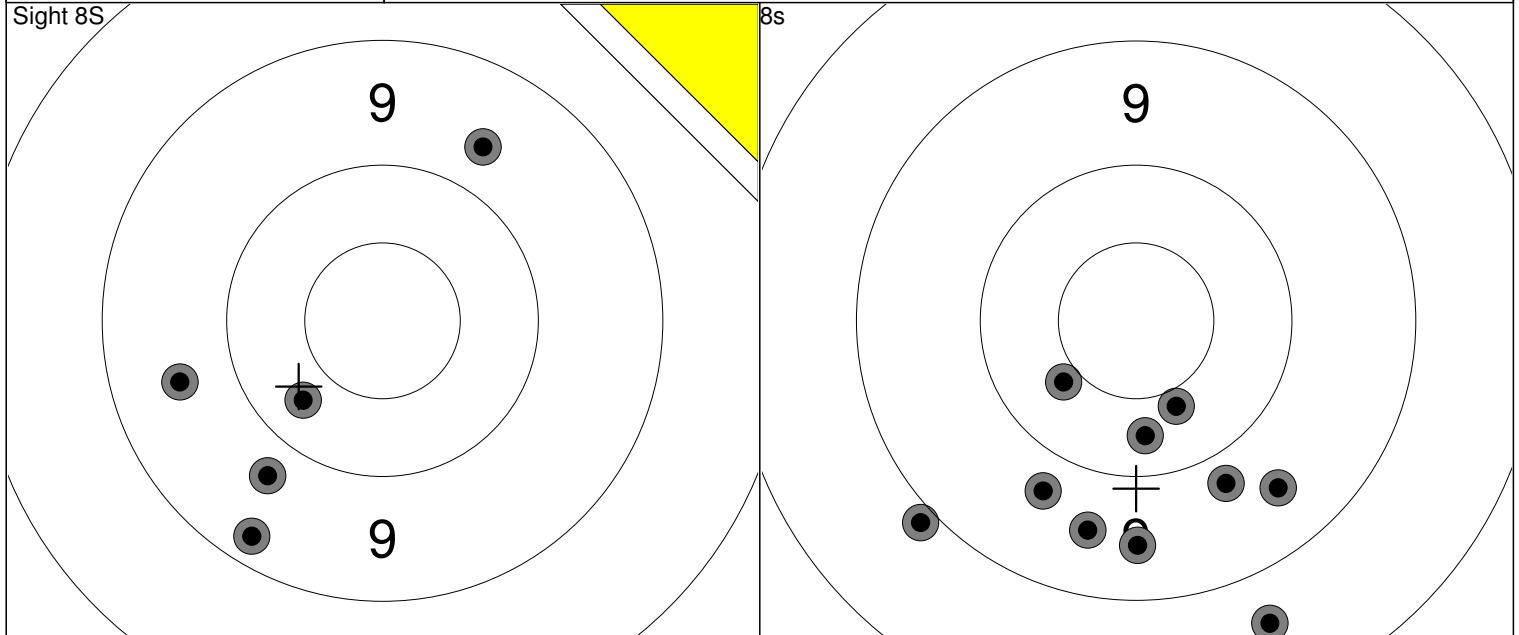

1: 2.41s 9.7 ↗	Series	46 (0x)	1: 2.14s 9.8 ↓	1: 2.24s 9.5 ↓	Series	91 (0x)
2: 3.83s 9.7 ↘		2: 3.12s 9.7 ↘	2: 3.18s 8.9 ↘			
3: 4.77s 10.3 ↘		3: 4.23s 10.4 ↓	3: 3.99s 9.5 ↓			
4: 5.77s 9.2 ↓		4: 5.13s 9.5 ↓	4: 4.81s 10.4 ↘			
5: 6.75s 9.6 ←		5: 6.26s 8.6 ↓	5: 5.71s 10.2 ↓			
		0 (0x)			91 (0x)	

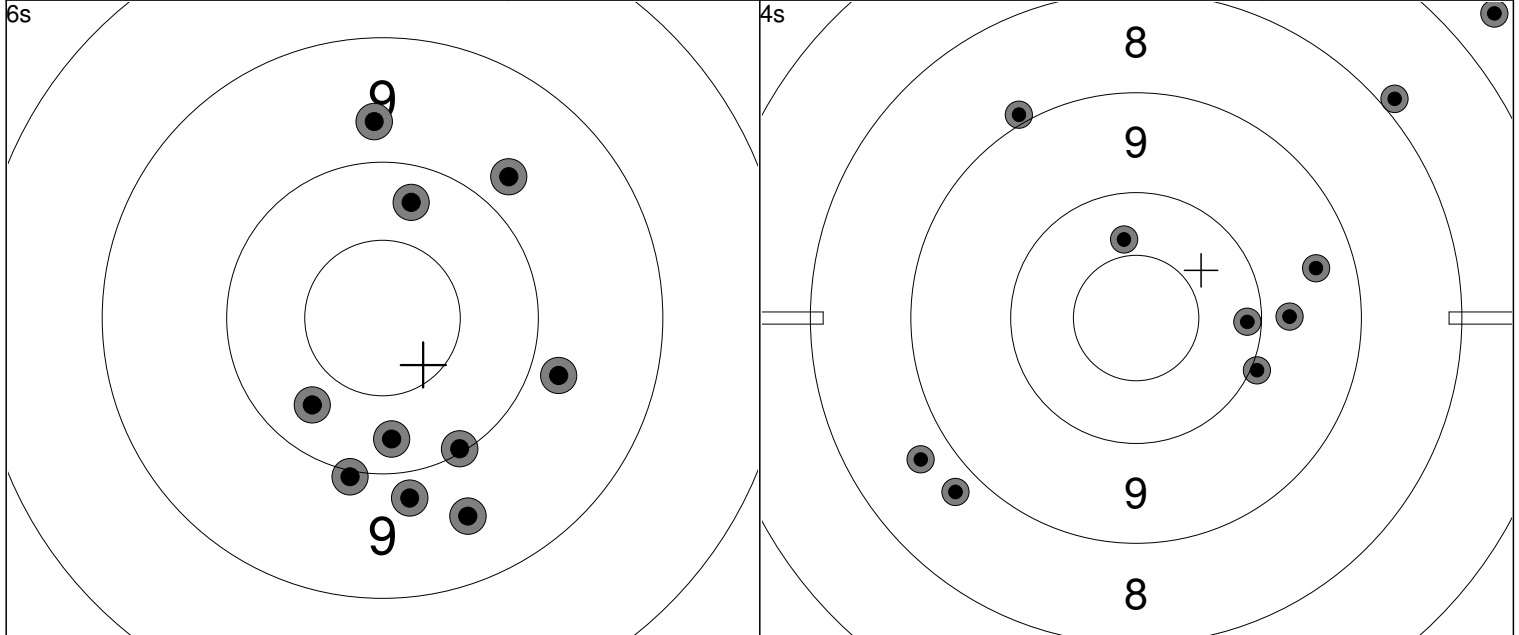

1: 1.94s 9.8 ↗	1: 1.81s 9.8 ↓	Series	95 (0x)	1: 1.66s 10.1 →	1: 1.61s 9.4 →	Series	85 (0x)
2: 2.87s 10.2 ↑	2: 2.77s 9.7 ↑		2: 2.22s 10.3 ↑	2: 2.11s 10.0 →			
3: 3.61s 9.8 →	3: 3.68s 10.0 ↓		3: 2.84s 8.7 ↘	3: 2.59s 9.7 →			
4: 4.48s 10.3 ↘	4: 4.52s 10.2 ↓		4: 3.23s 7.9 ↗	4: 3.03s 6.6 ↗			
5: 5.26s 10.0 ↓	5: 5.29s 9.5 ↓		5: 3.78s 8.9 ↖	5: 3.54s 8.8 ↘			
		186 (0x)			271 (0x)		

Relay 3	Lane 18	MARKEWICZ Alan
-------------------	-------------------	-----------------------

2023 SFC Pistol Nationals	AB	EX	MP
---------------------------	----	----	----

13.07.2023	23PNHRF1S1	Alberta Handgun Association
------------	------------	-----------------------------

Comment	Signature
---------	-----------

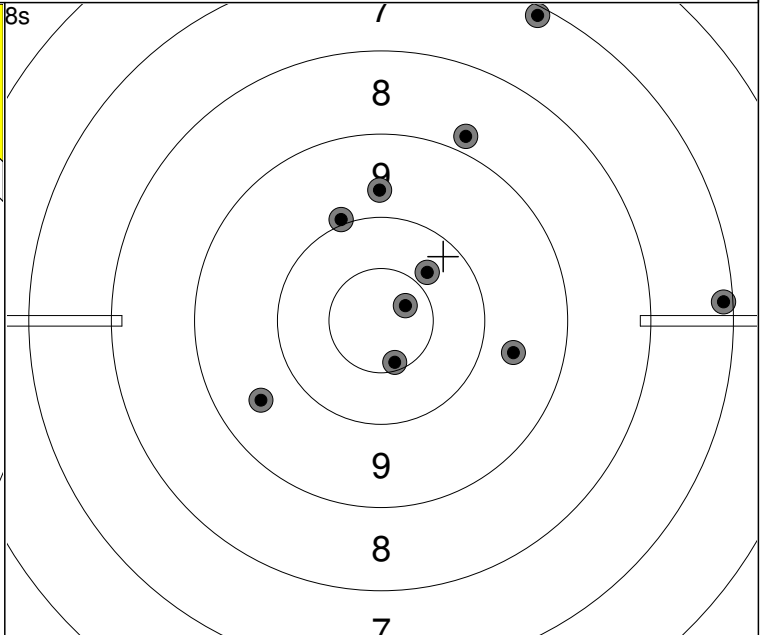
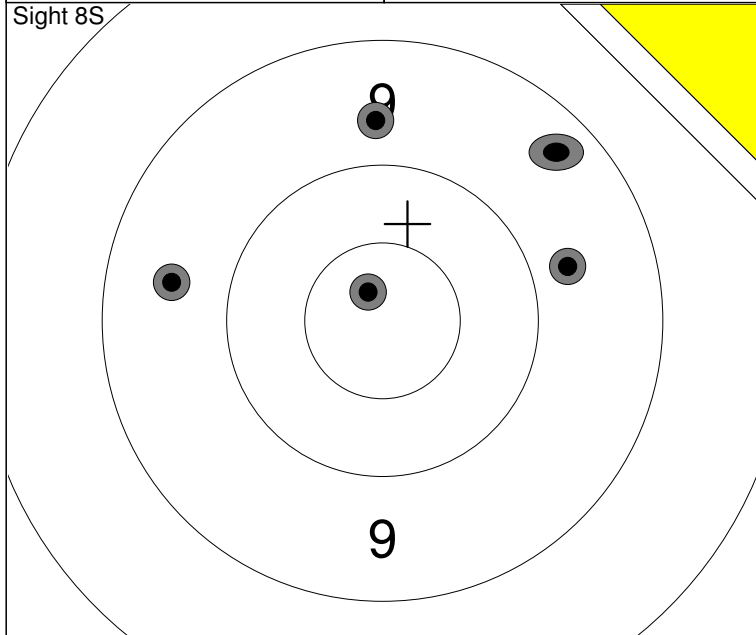

1: 3.17s 10.8x ↗
2: 4.83s 9.7 →
3: 6.47s 9.5 ←
4: 7.92s 9.7 ↑
5: 0.91s ↘

Series	37 (1x)
	0 (0x)

1: 2.67s 9.6 →
2: 3.75s 9.5 ↙
3: 4.77s 10.7x ↗
4: 5.87s 9.7 ↑
5: 6.92s 10.5x ↓

1: 2.65s 7.1 ↗
2: 3.69s 10.0 ↗
3: 4.84s 8.8 ↗
4: 5.76s 10.3 ↗
5: 6.95s 7.1 →

Series	89 (2x)
	89 (2x)

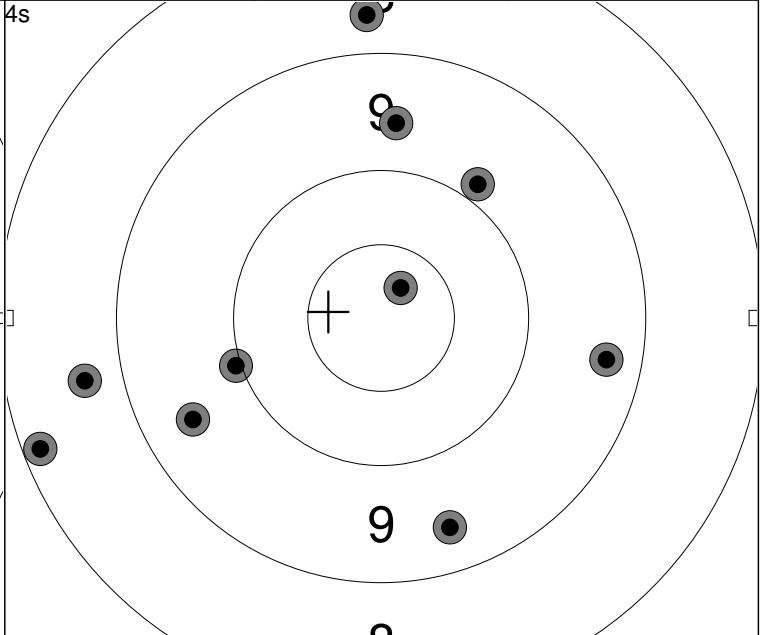
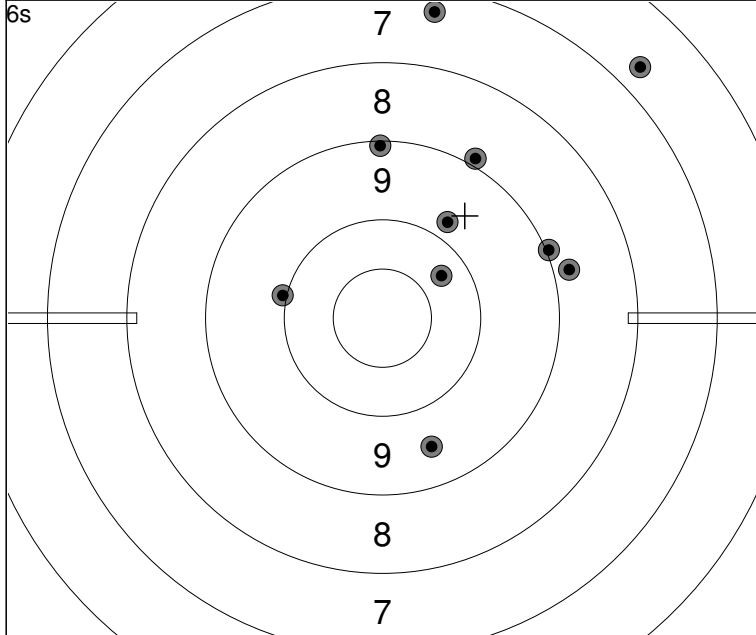

1: 1.93s 7.3 ↑
2: 2.77s 9.1 ↑
3: 3.75s 10.0 ←
4: 4.68s 8.9 ↗
5: 5.53s 8.8 →

1: 1.85s 9.5 ↓
2: 2.65s 10.2 ↗
3: 3.56s 6.7 ↗
4: 4.46s 9.8 ↗
5: 5.44s 9.0 →

Series	85 (0x)
	174 (2x)

1: 1.77s 9.4 ↓
2: 2.42s 9.5 ↙
3: 2.95s 9.6 ↑
4: 3.54s 8.7 ←
5: 4.14s 9.3 →

1: 1.85s 8.7 ↑
2: 2.51s 10.7x ↗
3: 3.15s 9.9 ↗
4: 3.72s 8.2 ←
5: 4.26s 10.0 ←

Series	89 (1x)
	263 (3x)

Relay 3	Lane 23	OLSEN Jesse
-------------------	-------------------	--------------------

2023 SFC Pistol Nationals	SK	EX	MP
---------------------------	----	----	----

13.07.2023	23PNHRF1S1	Alberta Handgun Association
------------	------------	-----------------------------

Comment	Signature
---------	-----------

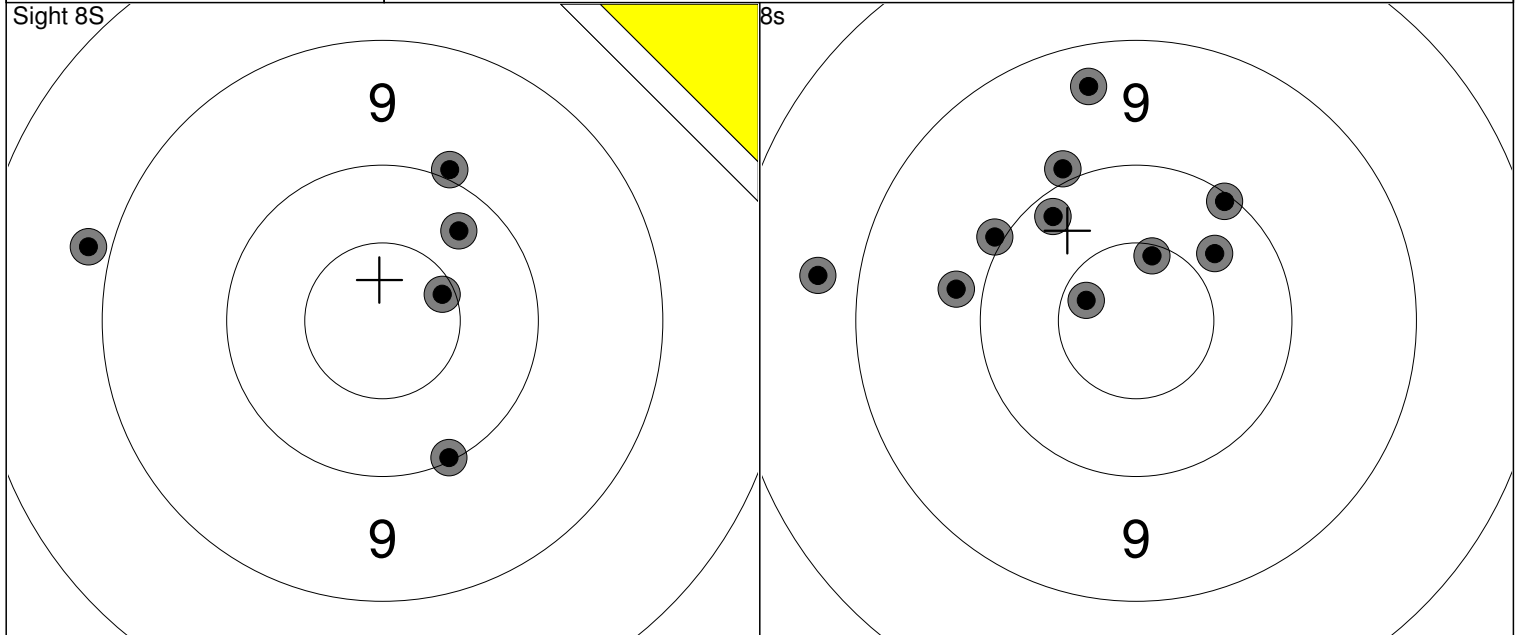

1: 2.46s 10.0 ↘	2: 3.81s 10.2 ↗	3: 4.90s 9.9 ↗	4: 5.96s 8.8 ←	5: 7.22s 10.6x →	Series 47 (1x)	1: 2.11s 10.0 ↖	2: 3.21s 9.8 ←	3: 4.20s 10.5x ↑	4: 5.29s 8.7 ←	5: 6.43s 10.0 ↗	Series 95 (2x)
					0 (0x)						Series 95 (2x)

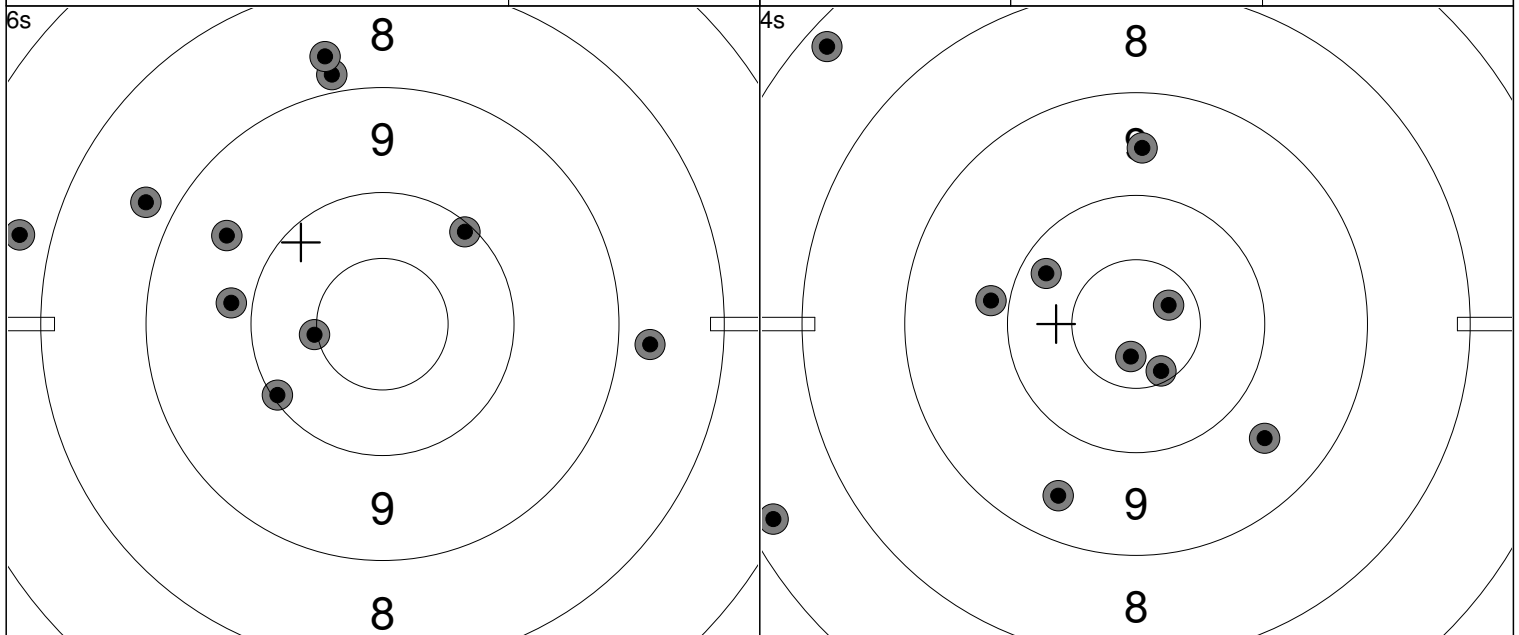

1: 2.03s 8.7 →	2: 2.77s 9.8 ←	3: 3.59s 8.8 ↑	4: 4.43s 7.7 ←	5: 5.40s 8.7 ↖	1: 2.05s 10.0 ←	2: 2.88s 9.6 ↖	3: 3.70s 10.5x ←	4: 4.54s 8.7 ↑	5: 5.42s 10.1 ↗	Series 87 (1x)	1: 1.59s 9.6 ↘	2: 2.16s 7.3 ↖	3: 2.70s 9.8 ←	4: 3.28s 10.2 ↖	5: 3.93s 10.7x ↓	1: 1.70s 9.4 ↘	2: 2.31s 10.7x →	3: 2.97s 10.6x ↓	4: 3.54s 7.2 ↗	5: 4.19s 9.6 ↑	Series 90 (3x)
					182 (3x)						Series 272 (6x)										

Relay 4	Lane 8	AASA Toomas
-------------------	------------------	--------------------

2023 SFC Pistol Nationals	ON	MA	MP
---------------------------	----	----	----

13.07.2023	23PNHRF1S1	Alberta Handgun Association
------------	------------	-----------------------------

Comment	Signature
---------	-----------

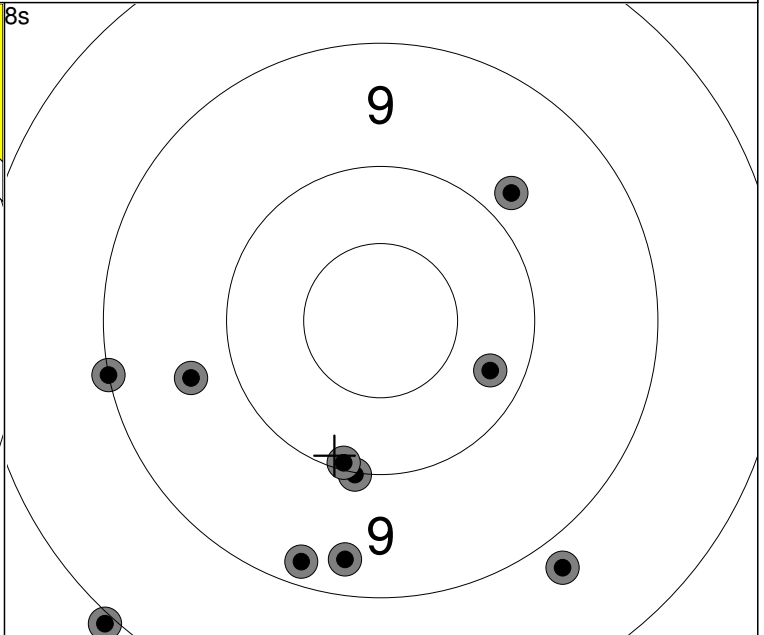
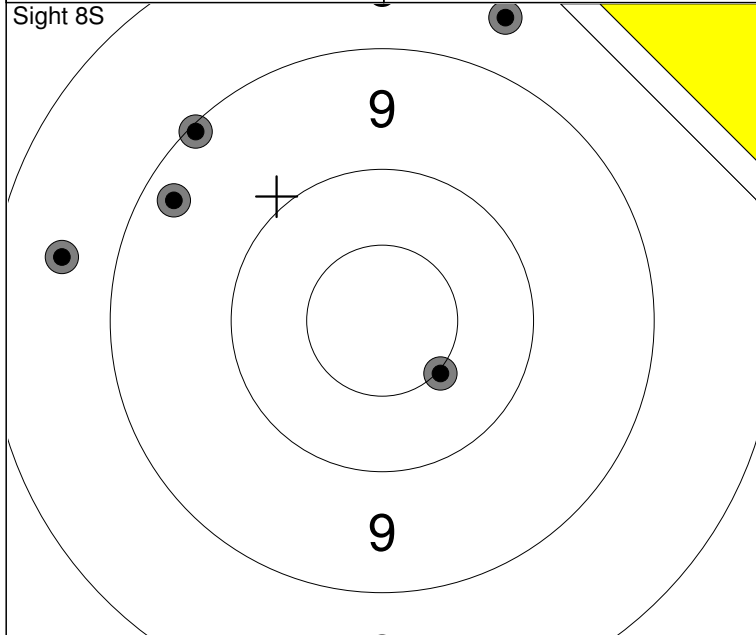

1: 1.88s	8.6	↗
2: 2.95s	8.6	↖
3: 4.02s	10.5x	↘
4: 5.15s	9.3	↗
5: 6.24s	9.1	↗

Series	44 (1x)
	0 (0x)

1: 1.98s	10.0	↘
2: 3.32s	8.8	↘
3: 4.35s	9.7	↖
4: 5.30s	9.2	↘
5: 6.32s	7.9	↘

1: 2.05s	9.8	↗
2: 2.98s	9.0	↖
3: 4.03s	9.3	↘
4: 5.01s	10.2	↗
5: 6.00s	10.0	↘

Series	90 (0x)
	90 (0x)

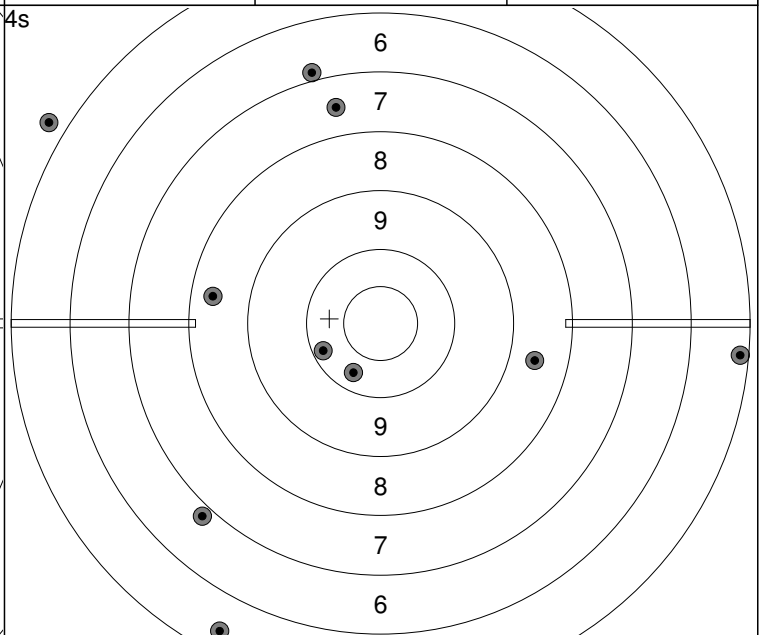
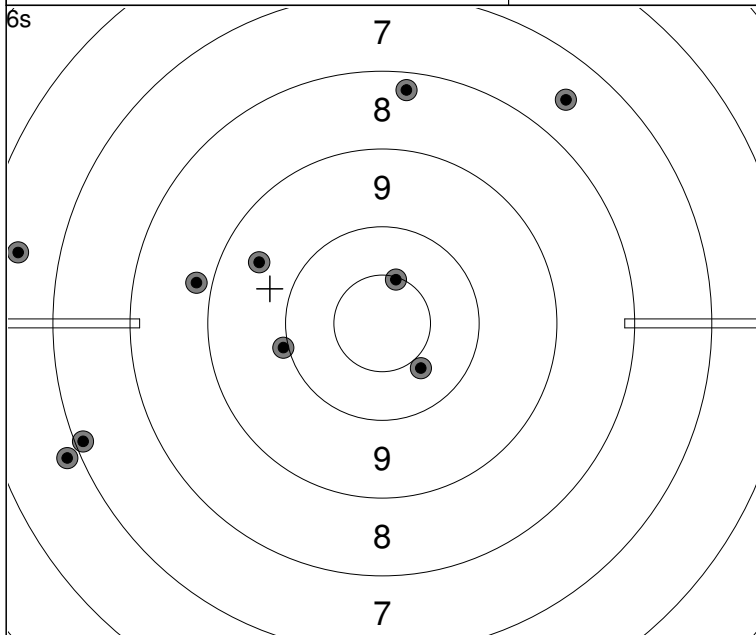

1: 2.12s	7.5	↗
2: 2.93s	7.1	↖
3: 3.87s	9.5	↖
4: 4.66s	8.8	↖
5: 5.51s	6.5	↖

1: 1.85s	8.2	↗
2: 2.84s	10.4	↘
3: 3.67s	10.0	↖
4: 4.63s	6.9	↖
5: 5.47s	10.5x	↗

Series	81 (1x)
	171 (1x)

1: 1.50s	6.8	↘
2: 2.08s	5.2	→
3: 2.63s	0.0	↖
4: 3.13s	8.4	↖
5: 3.63s	5.4	↘

1: 1.65s	7.5	↗
2: 2.36s	8.6	→
3: 3.00s	10.2	↘
4: 3.58s	6.9	↗
5: 4.14s	10.1	↖

Series	65 (0x)
	236 (1x)

Relay 4	Lane 23	KELLY Michael
-------------------	-------------------	----------------------

2023 SFC Pistol Nationals	NS	EX	MP
---------------------------	----	----	----

13.07.2023	23PNHRF1S1	Alberta Handgun Association
------------	------------	-----------------------------

Comment	Signature
---------	-----------

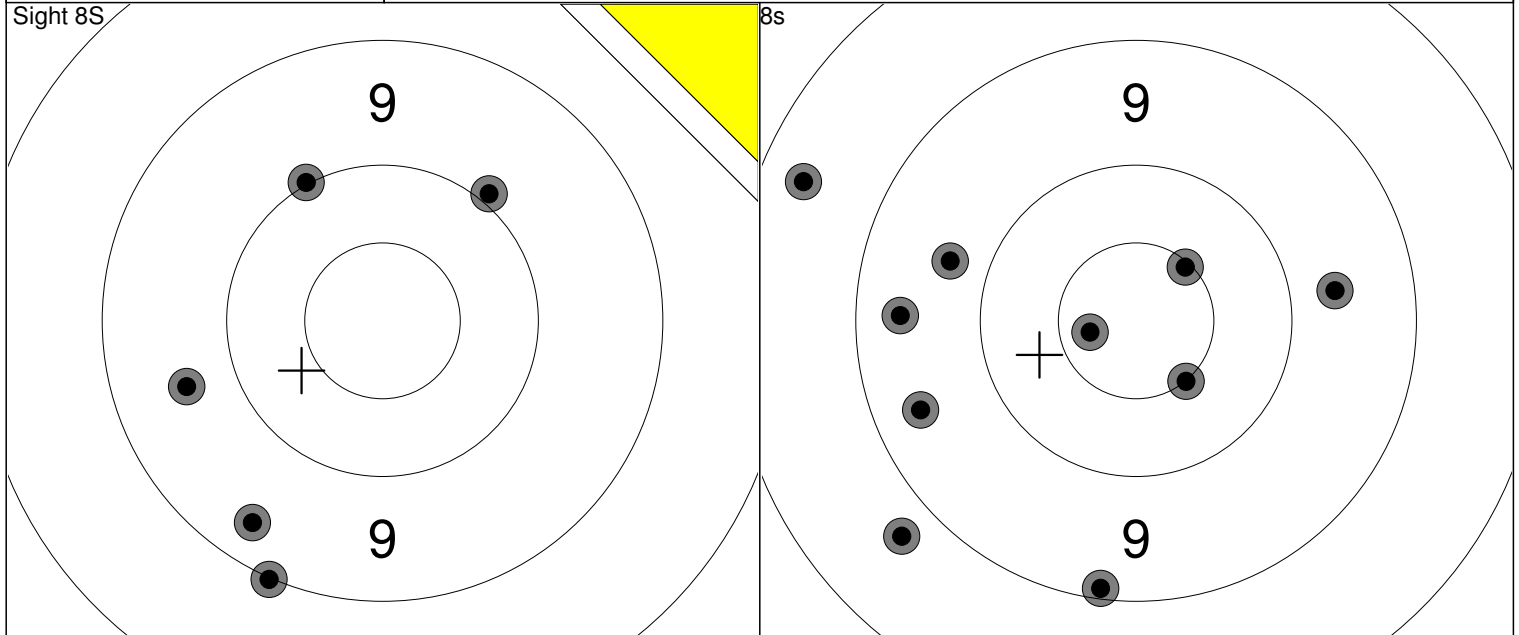

5: 2.96s 9.9 ↗	Series	46 (0x)	5: 3.03s 10.5x ↘	5: 2.13s 10.5x ↗	Series	91 (3x)
4: 4.13s 10.0 ↖		0 (0x)	4: 4.03s 9.7 ←	4: 3.14s 10.7x ←		91 (3x)
3: 5.06s 9.3 ↘			3: 5.02s 9.4 ←	3: 4.10s 9.7 →		
2: 6.05s 9.6 ←			2: 6.03s 8.7 ↘	2: 5.14s 9.1 ↓		
1: 7.17s 9.0 ↓			1: 7.09s 9.4 ←	1: 6.12s 8.4 ←		

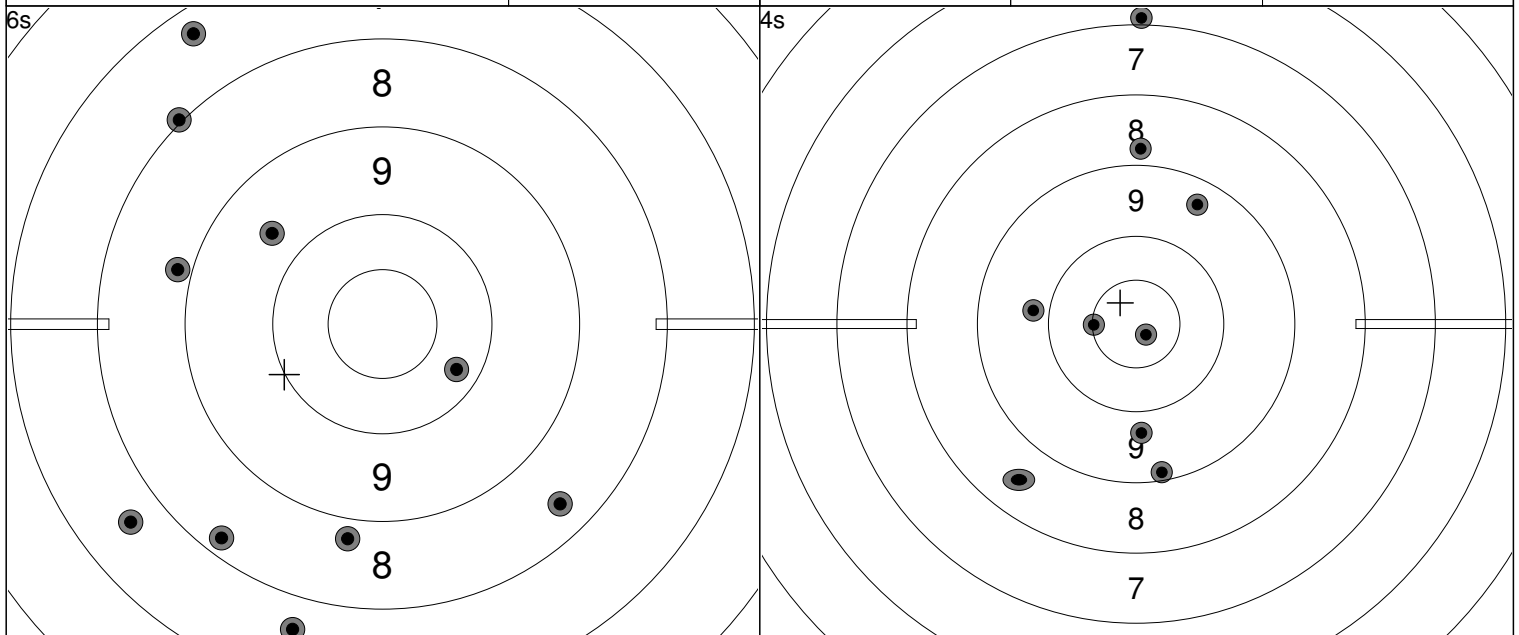

5: 1.98s 7.3 ↗	5: 2.06s 8.4 ↘	Series	80 (0x)	5: 1.76s 8.8 ↑	4: 2.53s 9.8 ←	Series	70 (2x)
4: 2.82s 8.2 ↘	4: 2.89s 7.6 ↘		171 (3x)	3: 3.15s 10.5x ←	3: 3.20s 9.7 ↓		241 (5x)
3: 3.88s 7.6 ←	3: 3.83s 8.8 ↘			2: 3.69s 6.9 ↑	2: 3.85s 9.1 ↓		
2: 4.60s 10.2 ↘	2: 4.63s 8.9 ←			1: 4.23s 9.4 ↗	1: 0.26s 7.4 ↘		
1: 5.28s 8.0 ↗	1: 5.45s 9.6 ↗			5: 1.91s 10.8x ↘			

Relay 1	Lane 3	<h1>NORMAN Seth</h1>
-------------------	------------------	----------------------

2023 SFC Pistol Nationals SK	IJ	MP
------------------------------	----	----

13.07.2023	23PNRF1S2	Alberta Handgun Association
------------	-----------	-----------------------------

Comment	Signature
---------	-----------

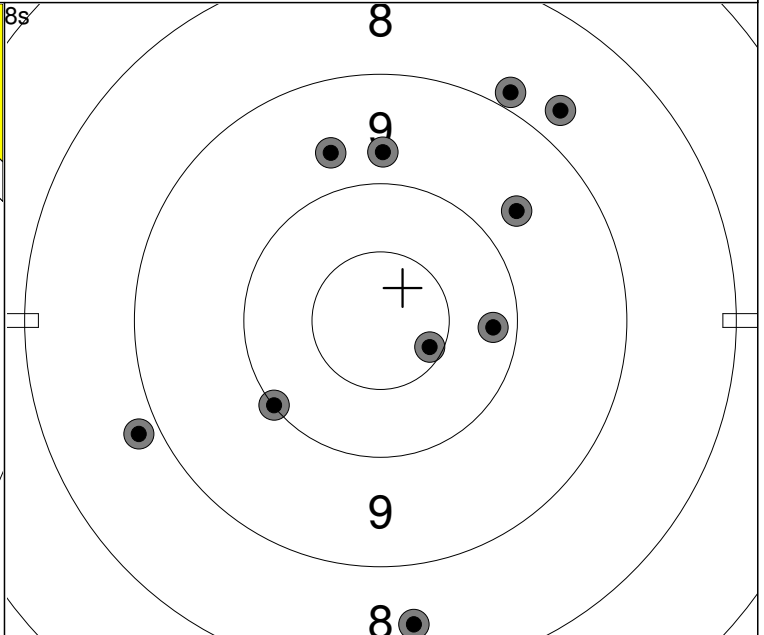
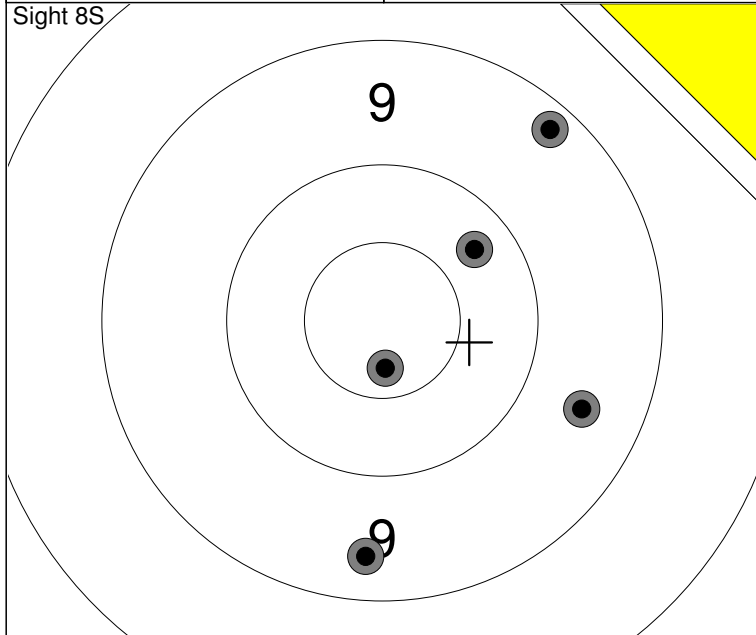

1: 2.38s 9.4 ↓
2: 3.44s 10.7x ↓
3: 4.47s 9.5 →
4: 5.55s 10.2 ↗
5: 6.53s 9.2 ↗

Series	47 (1x)
	0 (0x)

1: 1.92s 8.9 ↗
2: 3.01s 10.0 ↙
3: 4.08s 8.8 ↙
4: 5.63s 8.5 ↓
5: 6.81s 8.7 ↗

1: 2.24s 10.6x →
2: 3.24s 9.7 ↗
3: 4.25s 9.7 ↗
4: 5.50s 9.7 ↑
5: 6.67s 10.2 →

Series	89 (1x)
	89 (1x)

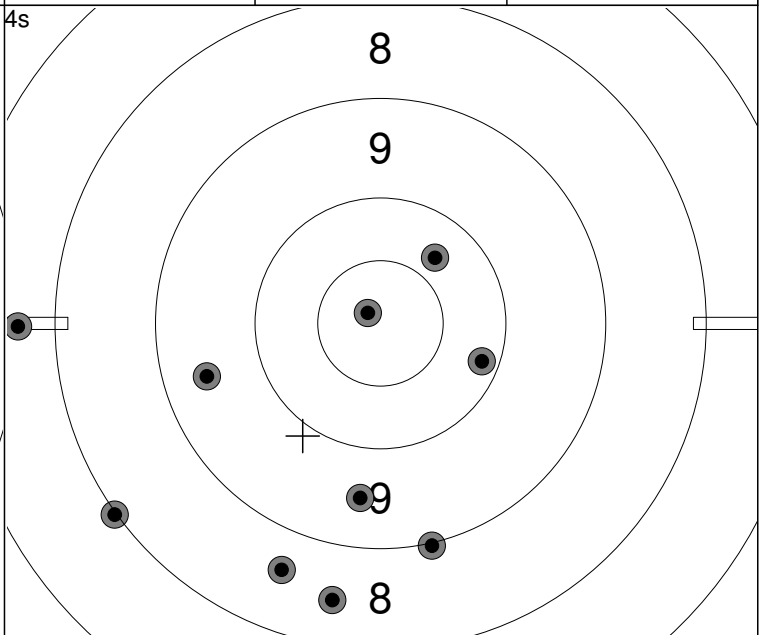
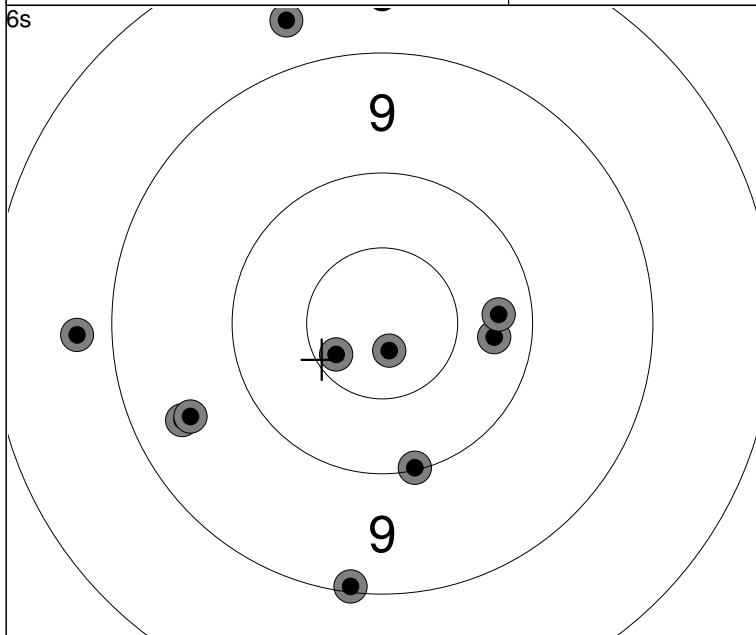

1: 1.91s 8.6 ↗
2: 2.76s 10.2 →
3: 3.59s 9.1 ↓
4: 4.39s 8.7 ←
5: 5.07s 9.4 ←

1: 1.67s 10.0 ↓
2: 2.55s 10.2 →
3: 3.53s 10.6x ↙
4: 4.33s 10.8x ↓
5: 5.19s 9.5 ←

Series	93 (2x)
	182 (3x)

1: 1.55s 9.0 ↓
2: 2.04s 8.0 ↙
3: 2.50s 7.6 ←
4: 3.05s 9.5 ↓
5: 3.50s 9.5 ←

1: 1.61s 10.8x ↙
2: 2.21s 8.5 ↓
3: 2.78s 8.6 ↓
4: 3.41s 10.1 →
5: 3.96s 10.3 ↗

Series	88 (1x)
	270 (4x)

Relay 1	Lane 8	<h1>NORMAN Rex</h1>
-------------------	------------------	---------------------

2023 SFC Pistol Nationals	SK	JR	MP
---------------------------	----	----	----

13.07.2023	23PNRF1S2	Alberta Handgun Association
------------	-----------	-----------------------------

Comment	Signature
---------	-----------

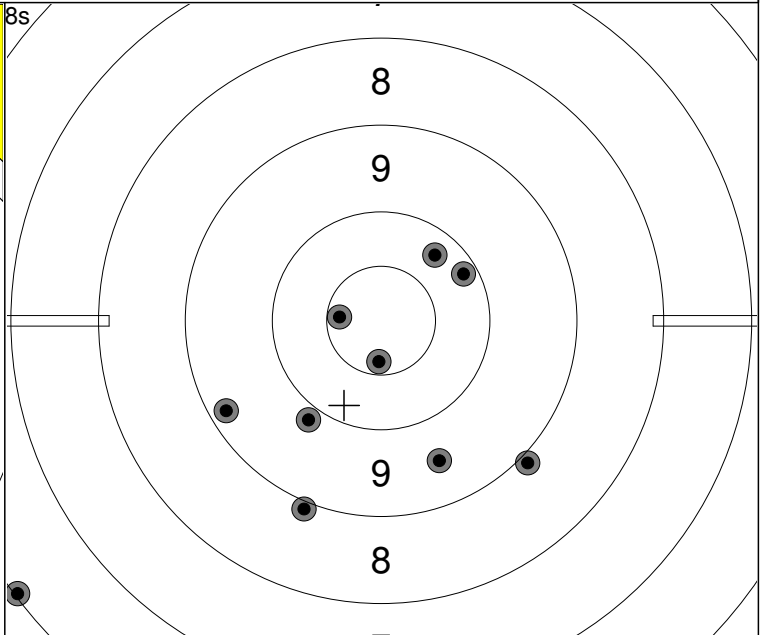
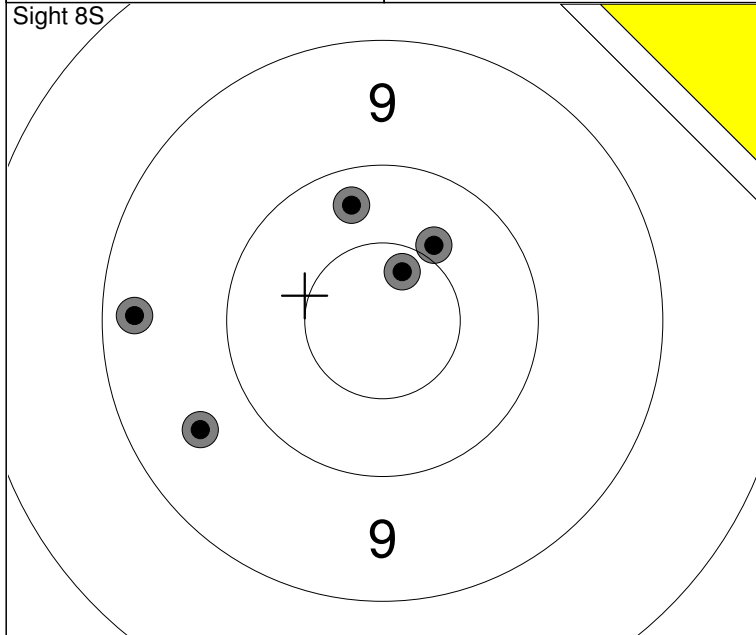

1: 2.71s 10.6x ↗
2: 3.60s 9.3 ←
3: 4.51s 10.2 ↗
4: 5.24s 10.4 ↗
5: 6.17s 9.6 ←

Series	48 (1x)
	0 (0x)

1: 2.23s 10.1 ↗
2: 3.58s 9.2 ↙
3: 4.41s 6.0 ↙
4: 5.41s 8.9 ↓
5: 6.21s 9.5 ↓

1: 2.12s 9.9 ↘
2: 3.04s 10.6x ←
3: 3.93s 10.2 ↗
4: 4.76s 10.6x ↓
5: 5.67s 8.9 ↘

Series	89 (2x)
	89 (2x)

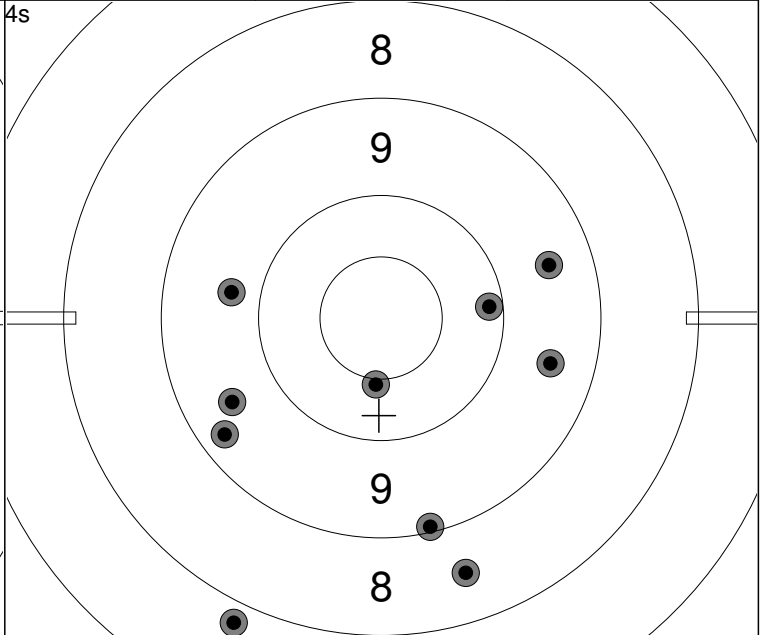
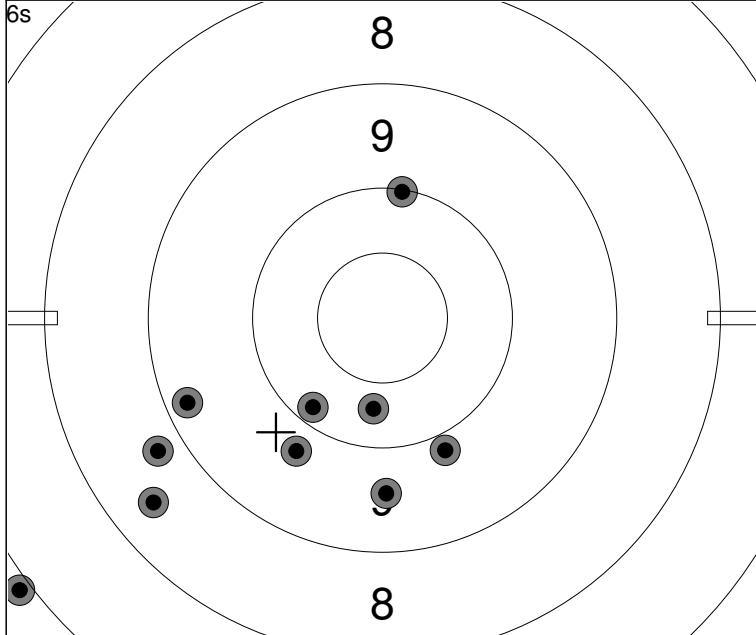

1: 2.23s 10.0 ↗
2: 3.03s 6.9 ↙
3: 3.81s 10.1 ↙
4: 4.39s 9.6 ↓
5: 5.02s 8.8 ↙

1: 1.95s 8.4 ↙
2: 2.76s 10.3 ↓
3: 3.41s 9.2 ←
4: 4.26s 9.7 ↙
5: 4.91s 9.9 ↓

Series	88 (0x)
	177 (2x)

1: 1.70s 9.5 →
2: 2.20s 9.5 →
3: 2.64s 9.7 ←
4: 3.16s 7.8 ↓
5: 3.62s 9.1 ↓

1: 1.57s 9.5 ↙
2: 2.49s 10.1 →
3: 2.90s 9.3 ↙
4: 3.35s 8.5 ↓
5: 3.83s 10.4x ↓

Series	89 (1x)
	266 (3x)

Relay 1	Lane 18	PADDA Davinderjit (dave)		
-------------------	-------------------	---------------------------------	--	--

2023 SFC Pistol Nationals	BC	EX	MP
---------------------------	----	----	----

13.07.2023	23PNRF1S2	Alberta Handgun Association
------------	-----------	-----------------------------

Comment	Signature
---------	-----------

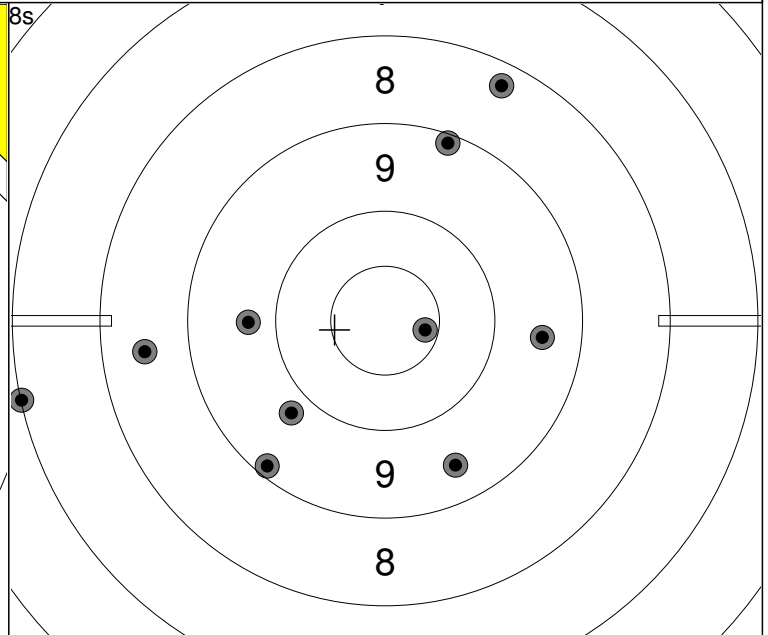
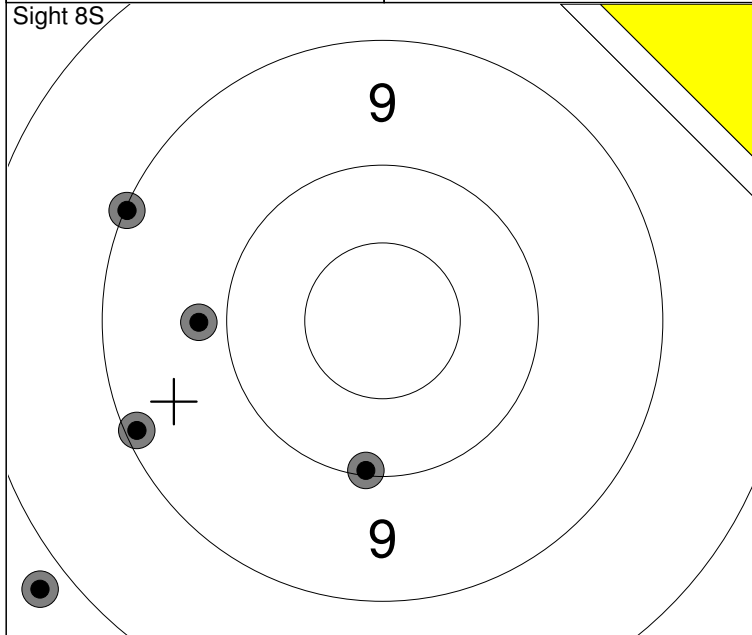

1: 2.52s 10.0 ↓
2: 3.77s 7.8 ↙
3: 4.85s 9.0 ↖
4: 5.95s 9.8 ←
5: 7.33s 9.1 ↙

Series	44 (0x)
Series	0 (0x)

1: 2.47s 9.5 →
2: 3.66s 8.5 ←
3: 4.76s 9.7 ←
4: 5.85s 9.1 ↗
5: 7.00s 8.3 ↗

1: 2.44s 9.4 ↓
2: 3.75s 7.0 ←
3: 5.07s 10.6x →
4: 6.23s 9.1 ↙
5: 7.50s 9.8 ↙

Series	87 (1x)
Series	87 (1x)

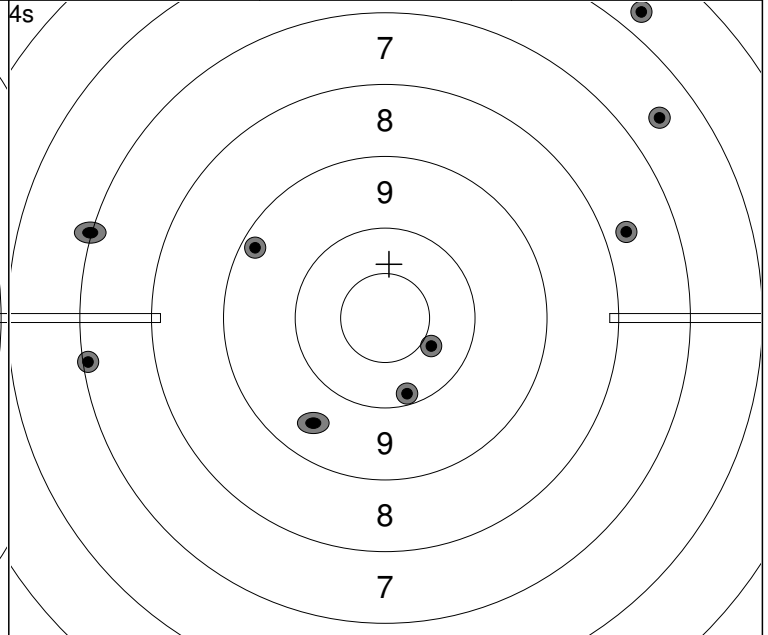
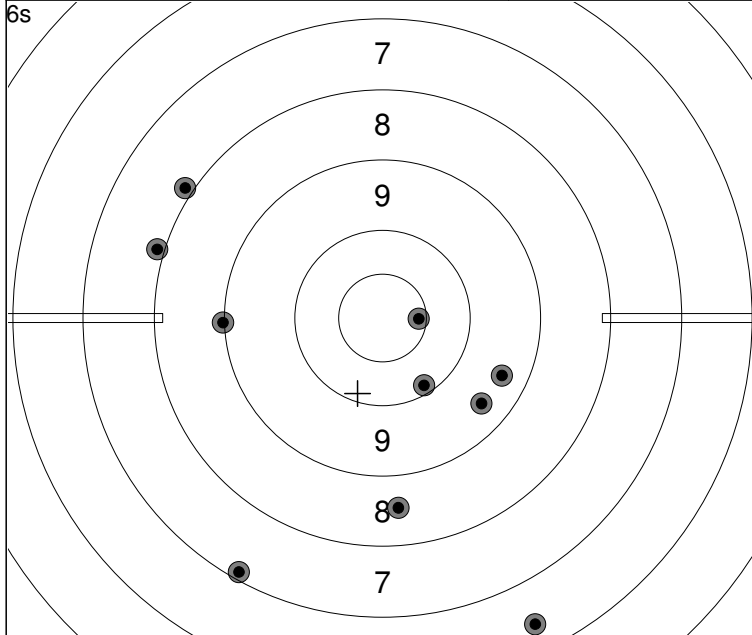

1: 2.08s 8.6 ↓
2: 3.15s 7.9 ↙
3: 4.25s 7.1 ↙
4: 5.10s 9.0 ←
5: 6.15s 10.6x →

1: 2.15s 9.4 →
2: 3.10s 7.9 ↖
3: 4.03s 6.4 ↙
4: 5.02s 10.1 ↙
5: 5.87s 9.4 ↙

Series	82 (1x)
Series	169 (2x)

1: 1.87s 10.4 ↘
2: 2.52s 10.1 ↓
3: 3.14s 5.7 ↗
4: 3.83s 9.2 ↖
5: 0.20s ↕

1: 1.79s 7.7 →
2: 2.41s ↗
3: 3.05s 6.5 ↗
4: 3.76s 7.1 ←
5: 0.07s ↕

Series	54 (0x)
Series	223 (2x)

Relay 1	Lane 23	ZHANG Zhuang
-------------------	-------------------	---------------------

2023 SFC Pistol Nationals	BC	EX	MP
---------------------------	----	----	----

13.07.2023	23PNRF1S2	Alberta Handgun Association
------------	-----------	-----------------------------

Comment	Signature
---------	-----------

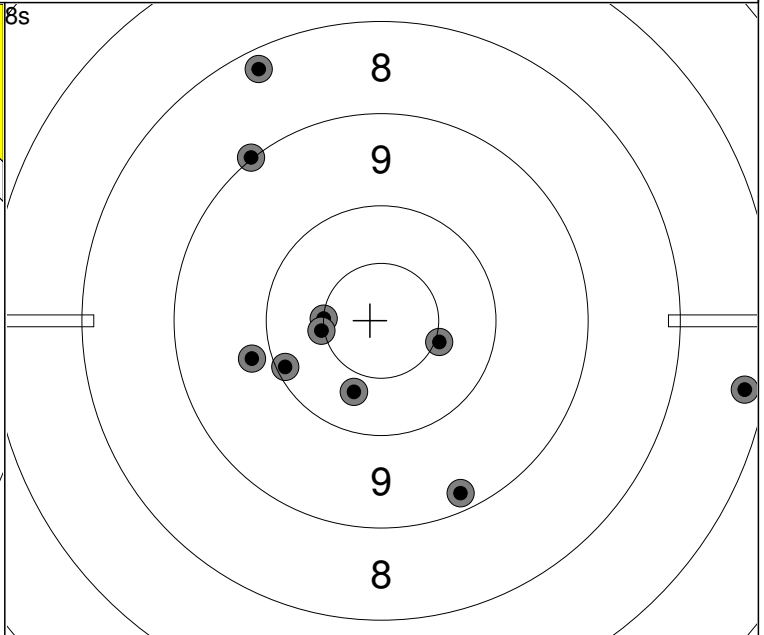
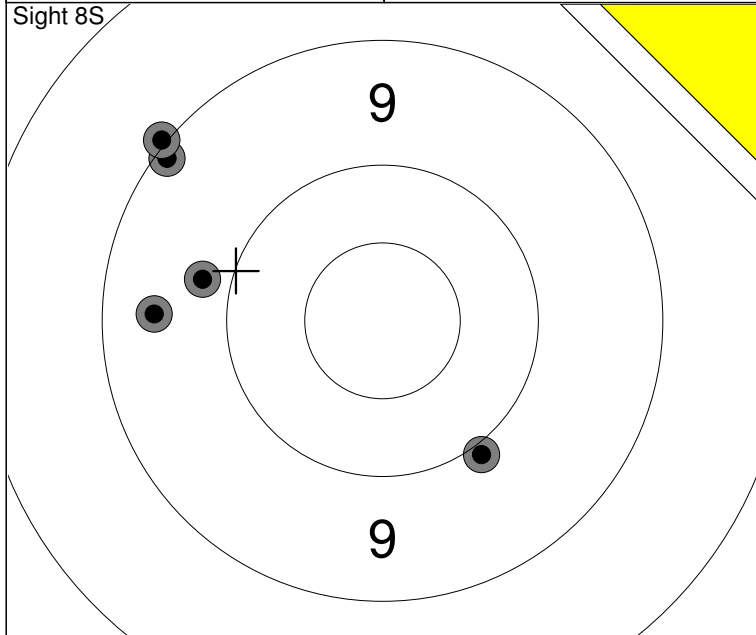

5: 2.22s	9.1	↗
4: 3.23s	9.9	↘
3: 4.16s	9.0	↗
2: 4.98s	9.4	←
1: 6.03s	9.8	←

Series	45 (0x)
Series	0 (0x)

5: 2.16s	7.2	→
4: 3.22s	9.2	↘
3: 4.18s	10.4x	→
2: 5.30s	9.8	←
1: 6.26s	9.0	↗

5: 2.32s	10.3	↘
4: 3.38s	10.5x	←
3: 4.24s	10.1	←
2: 5.16s	10.5x	←
1: 6.44s	8.2	↗

Series	92 (3x)
Series	92 (3x)

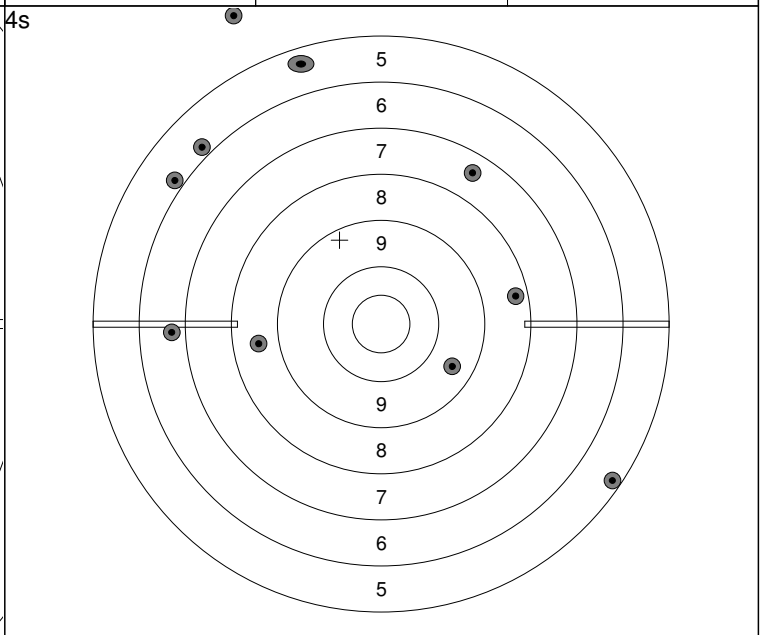
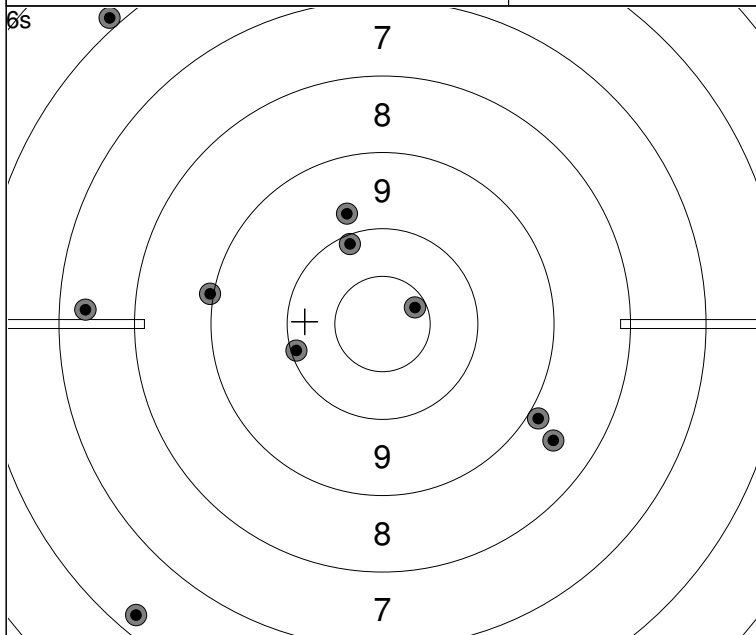

5: 1.80s	9.0	←
4: 2.70s	8.6	↘
3: 3.63s	10.6x	↗
2: 4.44s	8.9	↘
1: 5.18s	9.8	↗

5: 2.99s	5.9	↗
4: 3.71s	7.4	←
3: 4.55s	10.1	←
2: 5.21s	6.3	↘
1: 5.92s	10.1	↗

Series	82 (1x)
Series	174 (4x)

5: 1.50s	6.7	←
4: 2.03s	7.4	↗
3: 2.61s	5.8	↘
2: 3.23s	8.6	←
1: 3.77s	5.8	↘

5: 1.65s	8.3	→
4: 2.89s	9.5	↘
3: 3.39s	5.2	↘
2: 3.86s	0.0	↗
1: 0.06s	7.4	↘

Series	53 (0x)
Series	227 (4x)

Relay 2	Lane 3	SANDALL Jim
-------------------	------------------	--------------------

2023 SFC Pistol Nationals	MB	EX	MP
---------------------------	----	----	----

13.07.2023	23PNRF1S2	Alberta Handgun Association
------------	-----------	-----------------------------

Comment	Signature
---------	-----------

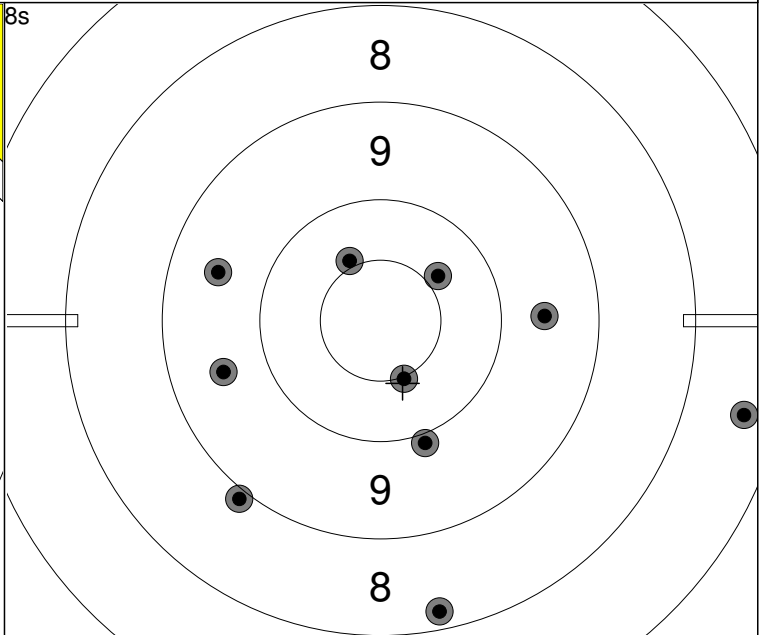
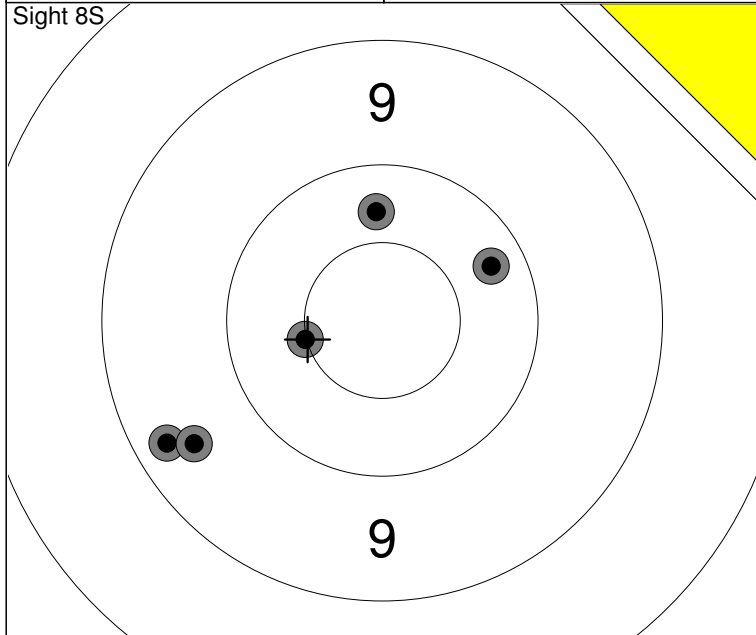

1: 3.12s 10.5x ←
2: 3.95s 9.3 ←
3: 4.80s 10.2 →
4: 5.62s 9.5 ←
5: 6.80s 10.3 ↑

Series	48 (1x)
	0 (0x)

1: 3.54s 7.4 →
2: 4.51s 8.2 ↓
3: 5.22s 9.6 →
4: 5.93s 10.5x ↓
5: 6.60s 9.9 ↓

1: 2.44s 10.4x ↗
2: 3.29s 9.6 ←
3: 4.13s 8.9 ↘
4: 5.00s 9.5 ←
5: 5.76s 10.4 ↗

Series	89 (2x)
	89 (2x)

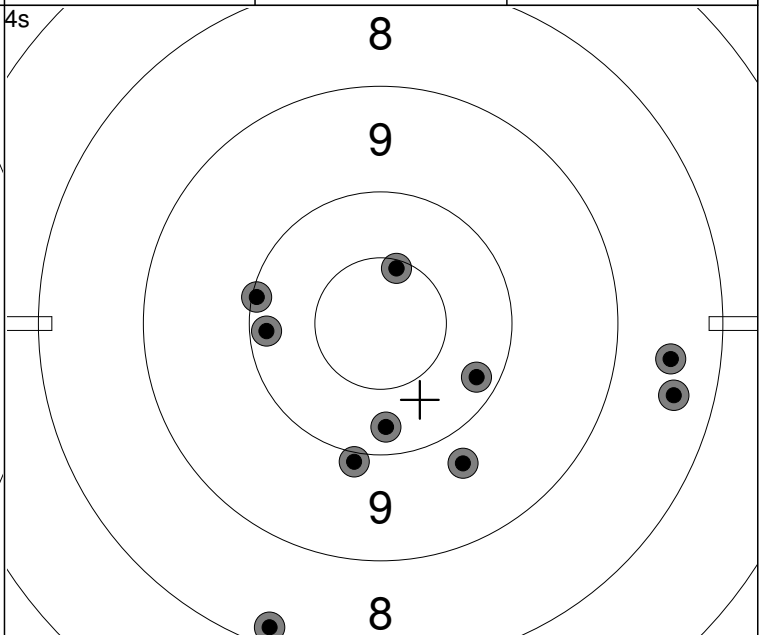
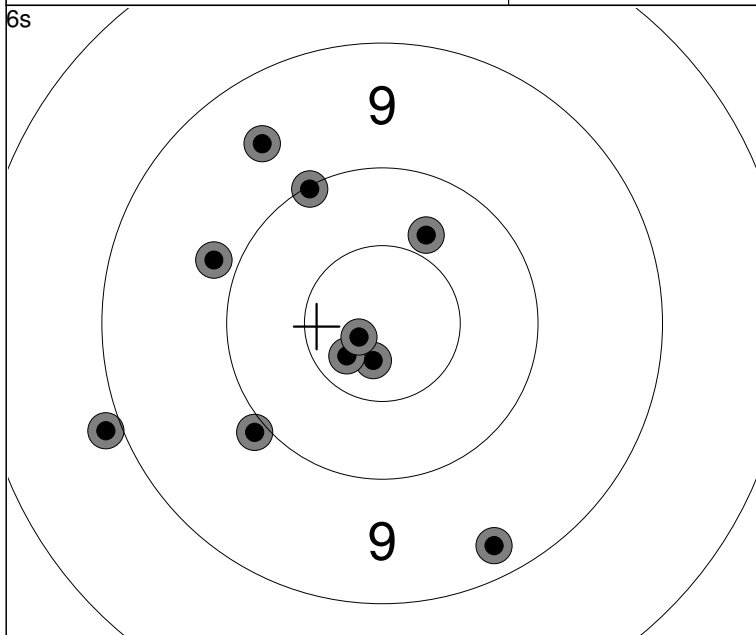

1: 2.73s 10.7x ↓
2: 3.41s 9.8 ←
3: 4.07s 10.7x ↘
4: 4.70s 9.9 ↘
5: 5.31s 8.9 ←

1: 2.41s 10.8x ←
2: 3.15s 10.0 ↗
3: 3.80s 9.5 ↗
4: 4.47s 9.3 ↓
5: 5.11s 10.3 ↗

Series	94 (3x)
	183 (5x)

1: 2.04s 9.7 ↓
2: 2.62s 10.2 ↘
3: 3.19s 8.2 ↓
4: 3.64s 8.4 →
5: 4.10s 10.5x ↑

1: 1.89s 8.5 →
2: 2.39s 9.9 ↓
3: 2.87s 10.2 ↓
4: 3.29s 10.1 ←
5: 3.71s 10.0 ←

Series	92 (1x)
	275 (6x)

Relay 2	Lane 8	WICK Werner
-------------------	------------------	--------------------

2023 SFC Pistol Nationals	AB	MA	MP
---------------------------	----	----	----

13.07.2023	23PNRF1S2	Alberta Handgun Association
------------	-----------	-----------------------------

Comment	Signature
---------	-----------

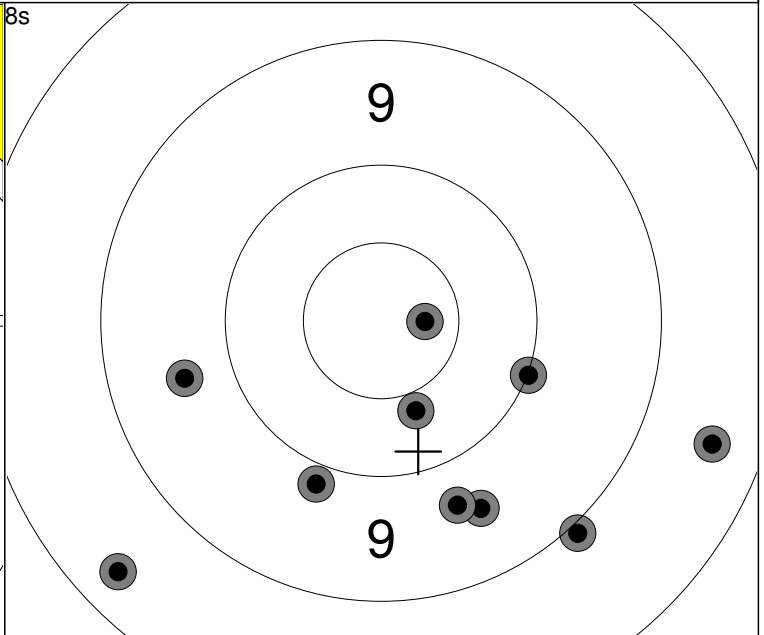
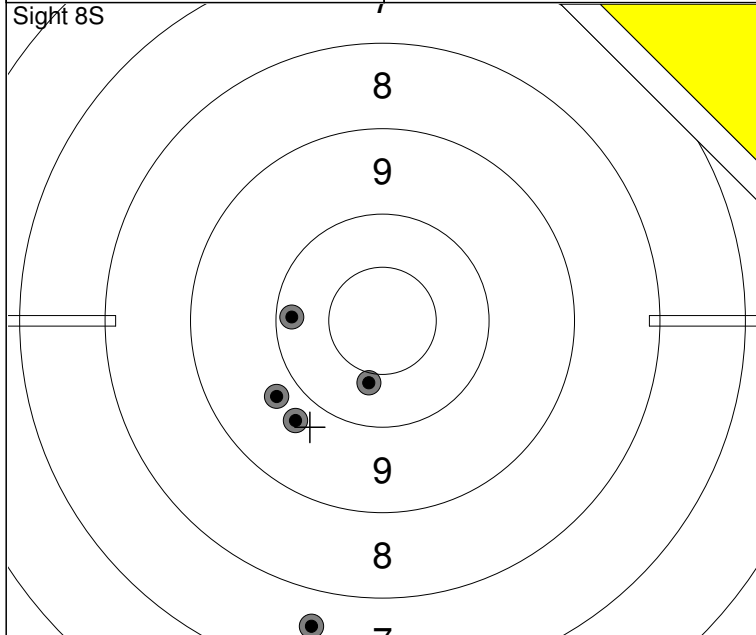

1: 2.23s 7.6 ↓
2: 3.31s 10.4 ↓
3: 4.08s 9.8 ↙
4: 5.22s 9.7 ↘
5: 6.20s 10.1 ←

Series	45 (0x)
	0 (0x)

1: 2.18s 9.6 ↓
2: 3.31s 10.4 ↓
3: 4.67s 9.9 ↓
4: 5.59s 10.7x →
5: 6.51s 8.4 →

1: 2.03s 8.4 ↙
2: 3.27s 9.7 ↓
3: 4.19s 10.0 →
4: 5.18s 9.6 ←
5: 6.03s 8.9 ↓

Series	90 (1x)
	90 (1x)

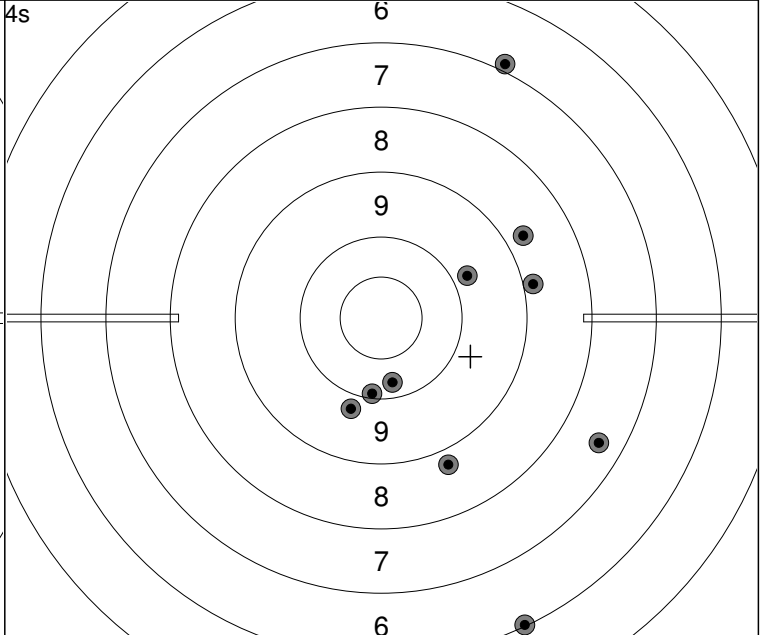
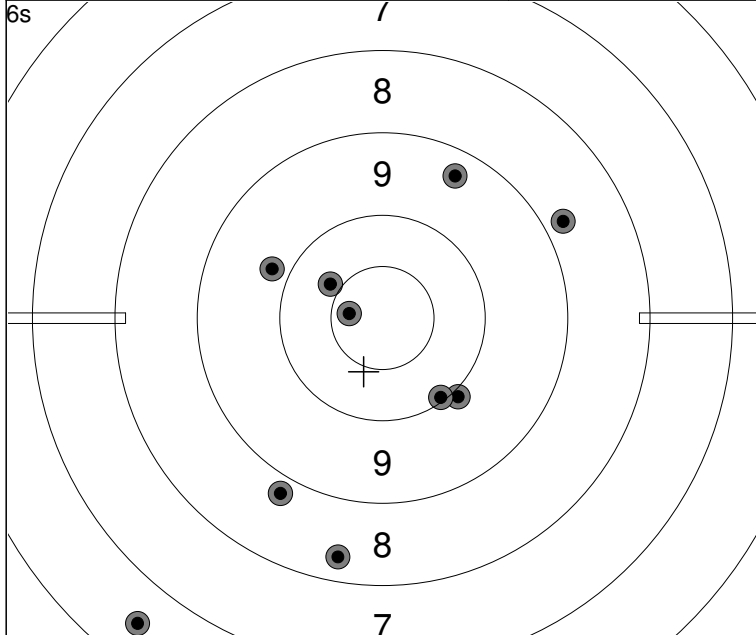

1: 2.08s 10.6x ←
2: 3.06s 8.8 →
3: 4.10s 9.9 ↓
4: 4.84s 8.3 ↓
5: 5.63s 8.8 ↓

1: 2.00s 9.8 ←
2: 2.93s 10.0 ↓
3: 3.67s 9.3 ↗
4: 4.50s 10.4 ↗
5: 5.22s 6.5 ↓

Series	87 (1x)
	177 (2x)

1: 1.83s 9.8 ↓
2: 2.41s 10.1 ↓
3: 2.96s 8.9 →
4: 3.48s 8.7 ↗
5: 4.05s 6.9 ↗

1: 1.68s 9.8 ↗
2: 2.21s 7.4 →
3: 2.72s 8.8 ↓
4: 3.21s 10.2 ↓
5: 3.65s 6.0 ↓

Series	81 (0x)
	258 (2x)

Relay 2	Lane 18	KELLY Michael
-------------------	-------------------	----------------------

2023 SFC Pistol Nationals	NS	EX	MP
---------------------------	----	----	----

13.07.2023	23PNRF1S2	Alberta Handgun Association
------------	-----------	-----------------------------

Comment	Signature
---------	-----------

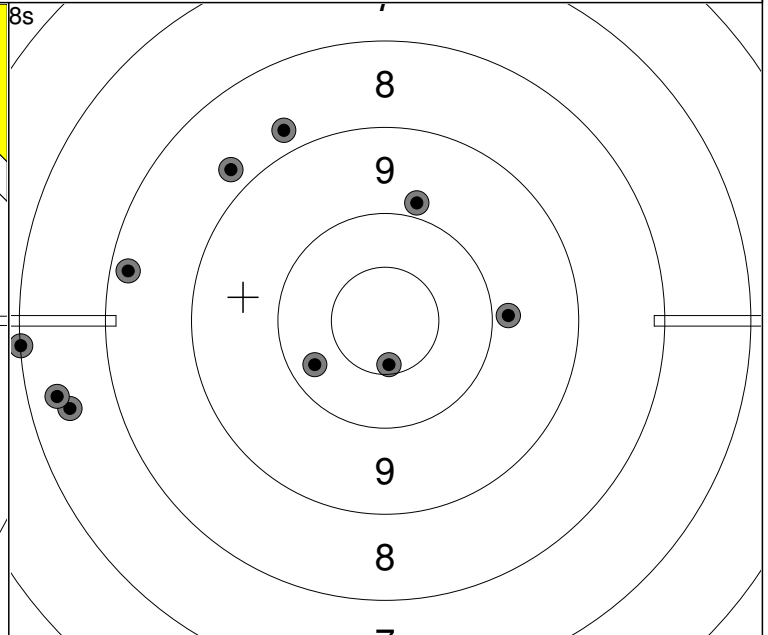
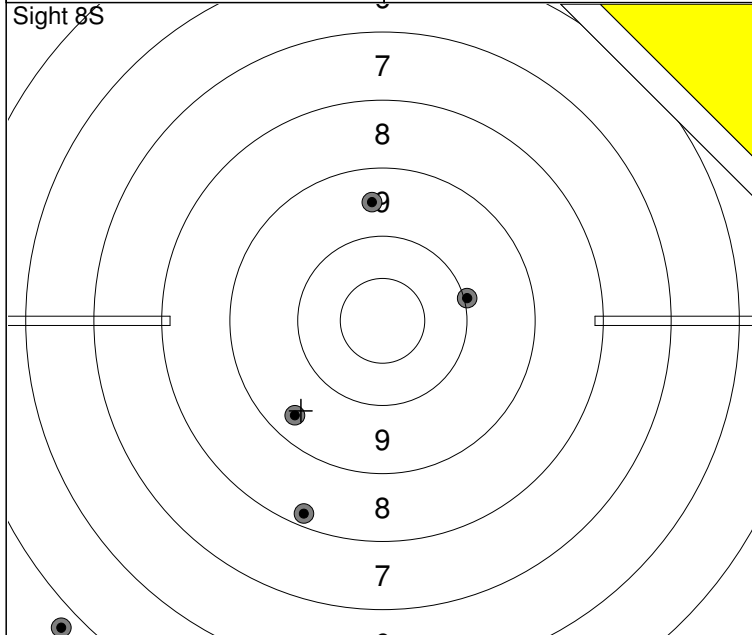

5: 2.05s	10.0	→
4: 3.00s	0.0	↙
3: 4.24s	9.4	↙
2: 5.25s	8.2	↘
1: 6.11s	9.5	↑

Series	36 (0x)
	0 (0x)

5: 2.12s	10.2	↙
4: 3.02s	10.6x	↘
3: 4.05s	8.8	↗
2: 4.85s	7.5	←
1: 5.79s	8.2	←

5: 2.08s	9.9	↑
4: 3.02s	9.8	→
3: 3.74s	8.8	↑
2: 4.50s	7.4	←
1: 5.33s	7.0	←

Series	83 (1x)
	83 (1x)

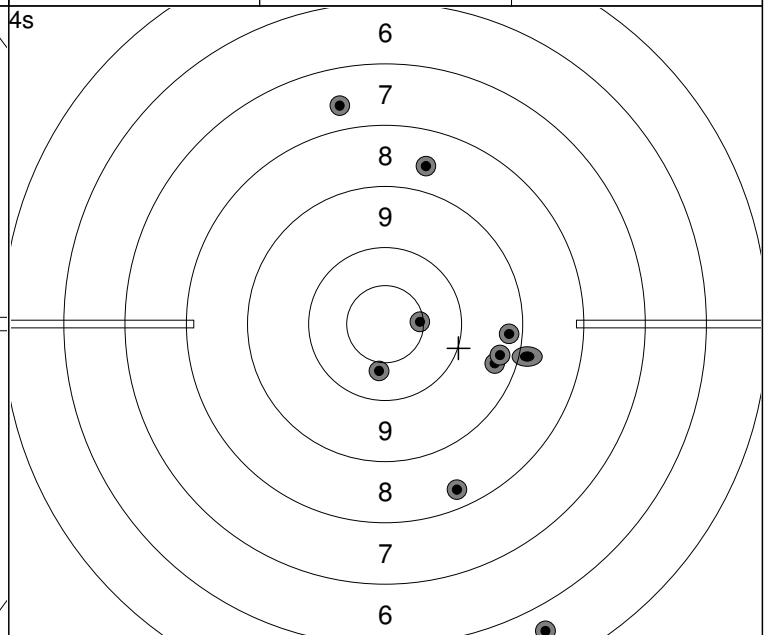
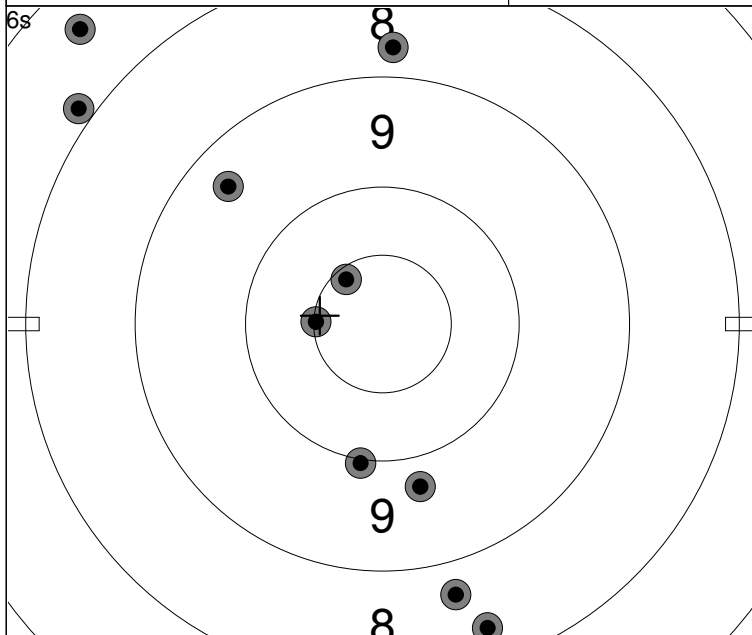

5: 2.10s	9.7	↘
4: 2.84s	9.4	↗
3: 3.49s	8.3	↘
2: 4.32s	7.4	↗
1: 5.04s	8.7	↑

5: 1.64s	10.5x	←
4: 2.39s	10.0	↘
3: 3.44s	10.6x	↗
2: 4.23s	7.9	↗
1: 5.08s	8.7	↘

Series	86 (2x)
	169 (3x)

5: 1.82s	9.4	→
4: 2.48s	10.4	↘
3: 3.03s	10.5x	→
2: 3.60s	9.2	→
1: 4.15s	7.6	↑

5: 1.75s	9.3	→
4: 2.53s	5.6	↘
3: 3.05s	8.3	↘
2: 3.77s	8.6	↑
1: 0.03s	7.4	↙

Series	75 (1x)
	244 (4x)

Relay 2	Lane 23	EK Nils
-------------------	-------------------	----------------

2023 SFC Pistol Nationals	QC	EX	MP
---------------------------	----	----	----

13.07.2023	23PNRF1S2	Alberta Handgun Association
------------	-----------	-----------------------------

Comment	Signature
---------	-----------

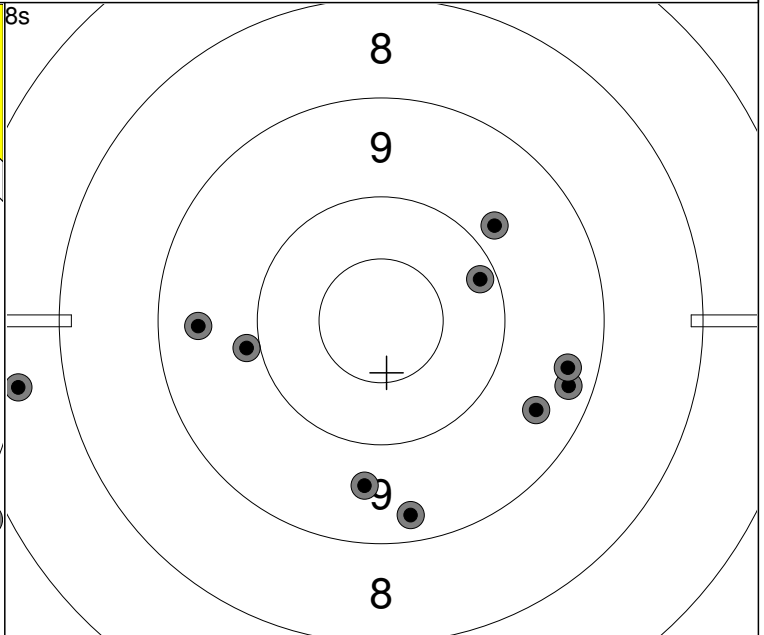
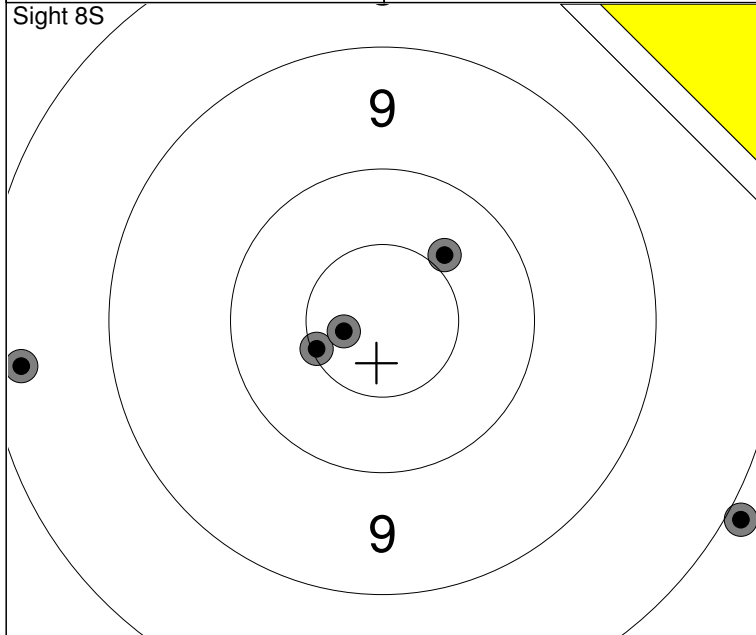

1: 2.56s 7.9 ↘
2: 3.75s 10.5x ↙
3: 5.01s 10.7x ↙
4: 6.24s 8.3 ↙
5: 7.33s 10.4 ↗

Series	45 (2x)
Series	0 (0x)

1: 2.33s 10.1 ↗
2: 3.40s 9.5 ↘
3: 4.46s 9.3 ↗
4: 5.71s 9.6 ↓
5: 6.85s 9.8 ↗

1: 2.29s 9.3 ↗
2: 3.43s 9.4 ↙
3: 4.67s 9.9 ↙
4: 5.75s 7.5 ↙
5: 7.05s 9.3 ↓

Series	89 (0x)
Series	89 (0x)

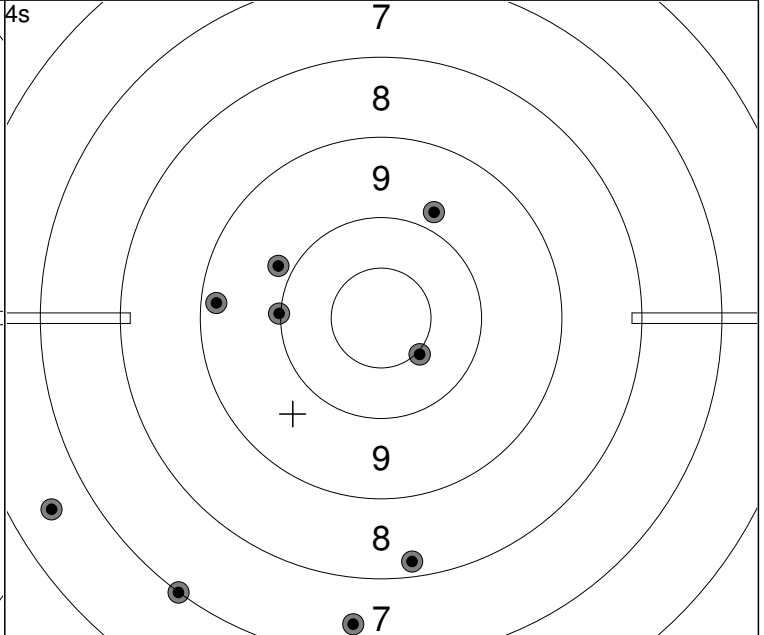
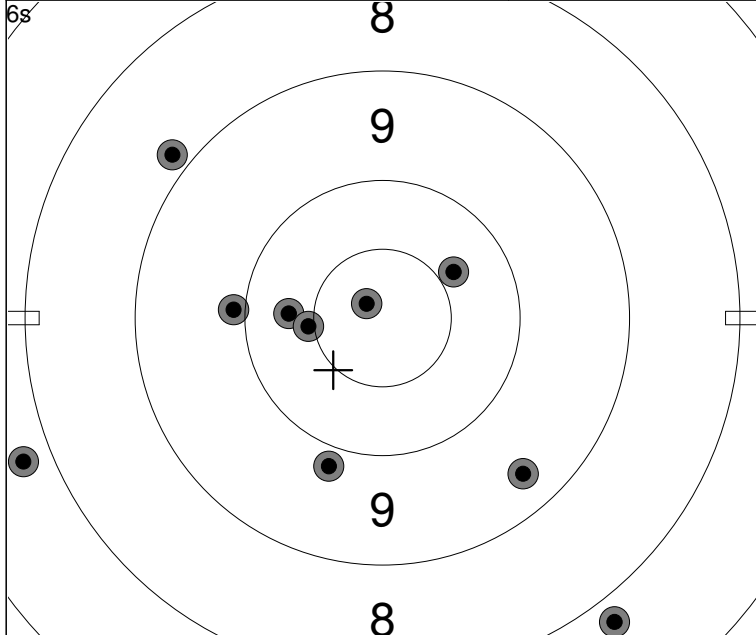

1: 2.06s 10.4 ↗
2: 3.05s 9.8 ↓
3: 3.92s 9.9 ↙
4: 4.77s 10.8x ↗
5: 5.61s 7.8 ↓

1: 2.11s 9.4 ↓
2: 3.05s 8.8 ↗
3: 3.97s 10.3 ↙
4: 4.91s 7.7 ↙
5: 5.74s 10.4x ↙

Series	89 (2x)
Series	178 (2x)

1: 1.72s 10.5x ↓
2: 2.28s 8.2 ↓
3: 2.89s 10.0 ↙
4: 3.46s 9.2 ↙
5: 4.02s 7.4 ↓

1: 1.65s 9.8 ↗
2: 2.61s 9.8 ↙
4: 3.64s 6.5 ↙
5: 4.11s 7.0 ↓

Series	75 (1x)
Series	253 (3x)

Relay 3	Lane 3	OLSEN Jesse
-------------------	------------------	--------------------

2023 SFC Pistol Nationals	SK	EX	MP
---------------------------	----	----	----

13.07.2023	23PNRF1S2	Alberta Handgun Association
------------	-----------	-----------------------------

Comment	Signature
---------	-----------

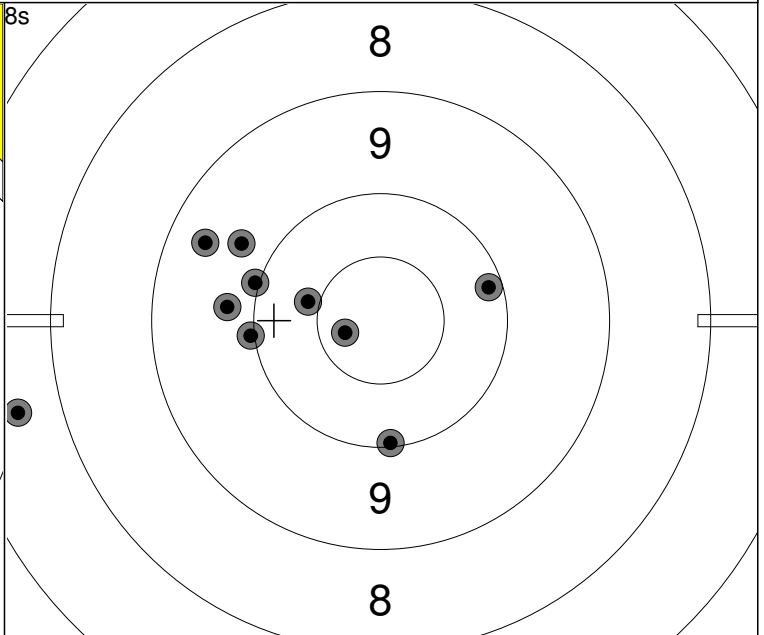
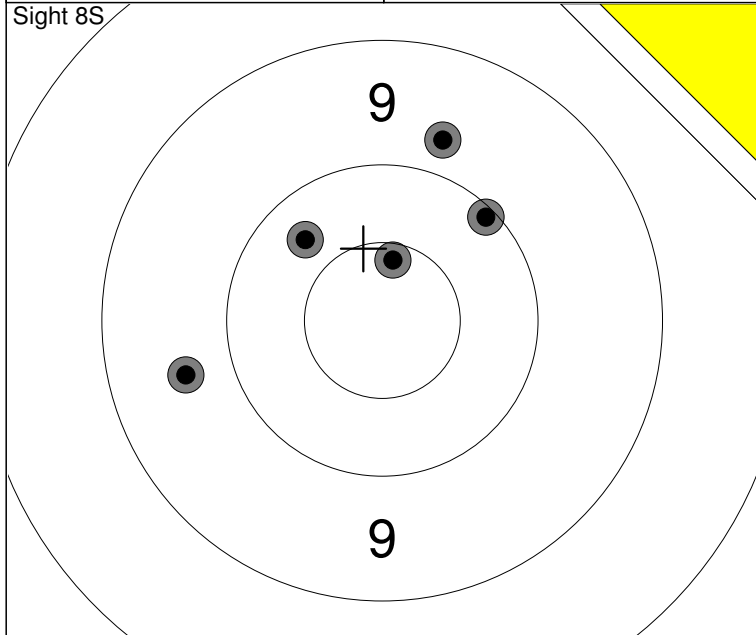

1: 2.90s 9.6 ←
2: 4.24s 10.6x ↑
3: 5.30s 10.1 ↗
4: 6.38s 9.7 ↑
5: 7.65s 10.3 ↖

Series	48 (1x)
	0 (0x)

1: 2.22s 10.0 ↓
2: 3.37s 10.1 →
3: 4.63s 10.0 ←
4: 5.74s 10.4 ←
5: 6.88s 9.7 ↖

1: 2.58s 10.7x ←
2: 3.85s 10.0 ←
3: 5.13s 9.8 ←
4: 6.24s 9.4 ←
5: 7.48s 7.6 ←

Series	94 (1x)
	94 (1x)

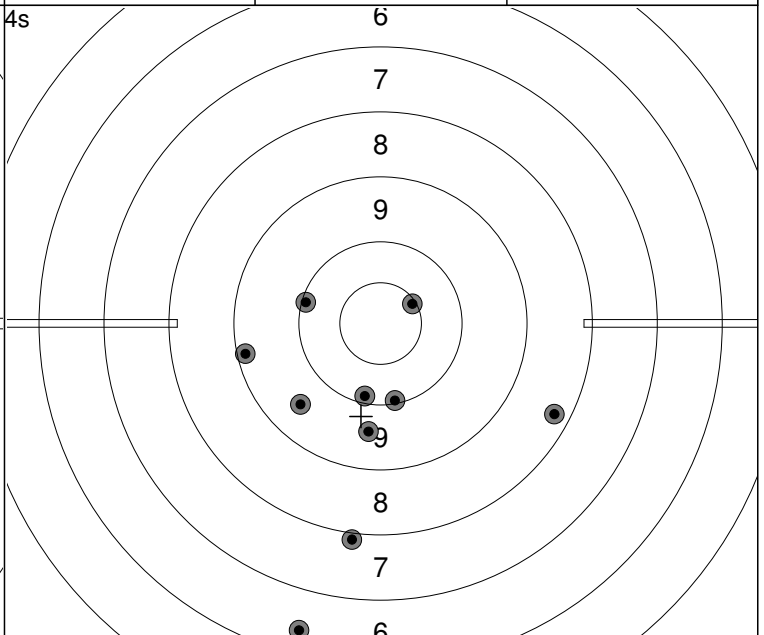
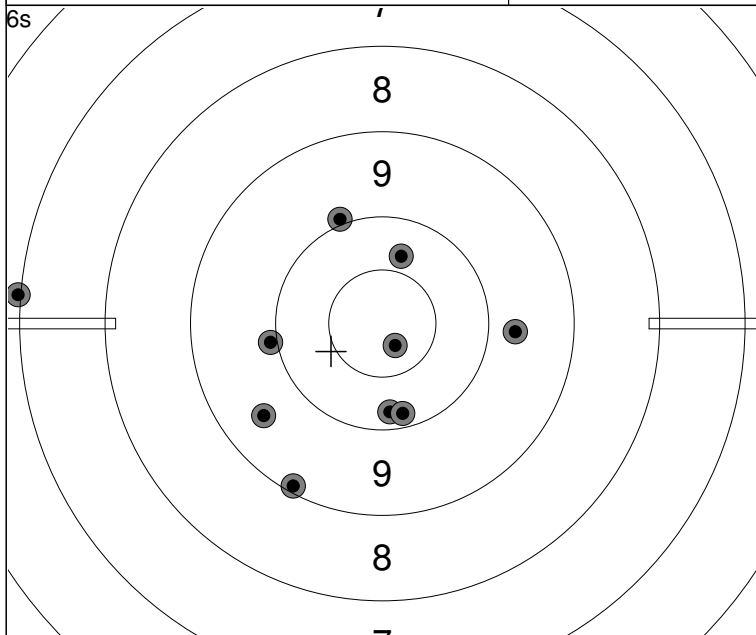

1: 1.87s 9.7 →
2: 2.86s 10.7x ↓
3: 3.61s 10.2 ↓
4: 4.50s 10.3 ↑
5: 5.30s 9.5 ←

1: 2.16s 7.0 ←
2: 2.94s 10.1 ↓
3: 3.68s 9.1 ↓
4: 4.46s 9.9 ←
5: 5.26s 10.0 ↑

Series	93 (1x)
	187 (2x)

1: 1.46s 9.6 ↓
2: 1.97s 6.4 ↓
3: 2.49s 10.1 ↓
4: 3.04s 8.3 →
5: 3.63s 10.0 ↓

1: 1.64s 10.0 ←
2: 2.18s 7.9 ↓
3: 2.78s 9.5 ↖
4: 3.33s 10.5x ↗
5: 3.90s 9.1 ←

Series	88 (1x)
	275 (3x)

Relay 3	Lane 8	PYLE Thomas
-------------------	------------------	--------------------

2023 SFC Pistol Nationals	BC	MA	MP
---------------------------	----	----	----

13.07.2023	23PNRF1S2	Alberta Handgun Association
------------	-----------	-----------------------------

Comment	Signature
---------	-----------

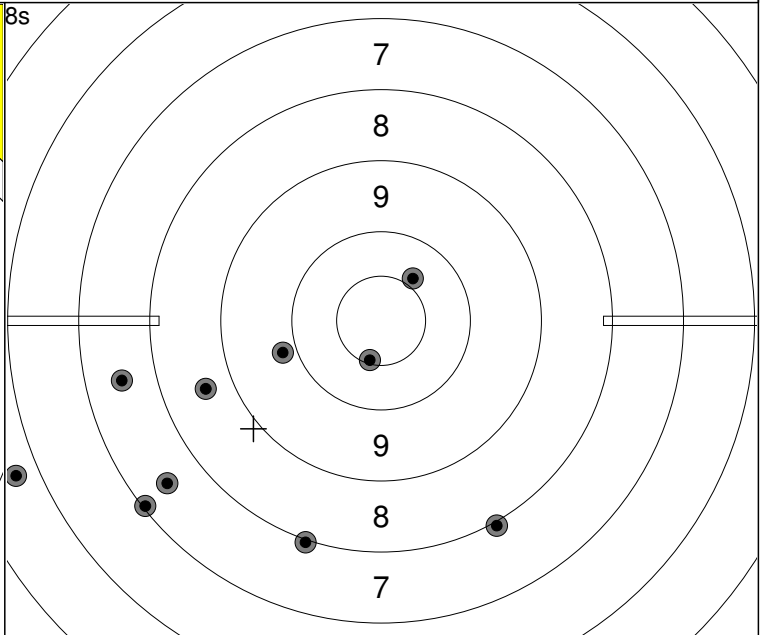
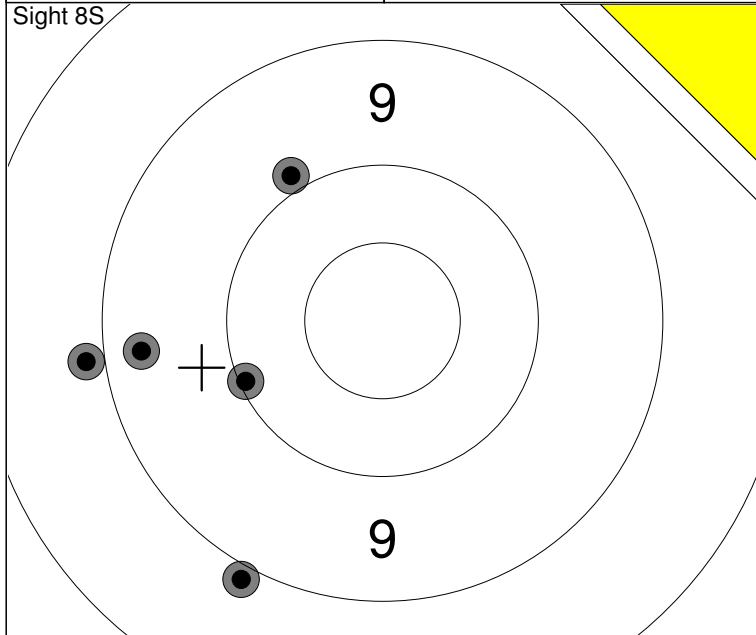

1: 1.91s 9.3 ←
2: 2.79s 8.9 ↘
3: 3.89s 9.9 ↗
4: 5.02s 10.0 ←
5: 5.97s 8.9 ←

Series	44 (0x)
	0 (0x)

1: 1.88s 5.7 ←
2: 2.70s 10.4 ↗
3: 3.49s 8.0 ↘
4: 4.35s 8.6 ←
5: 5.20s 10.5x ↘

1: 2.04s 9.8 ←
2: 2.87s 7.1 ↘
3: 3.75s 8.0 ↘
4: 4.62s 7.5 ↘
5: 5.53s 7.5 ←

Series	79 (1x)
	79 (1x)

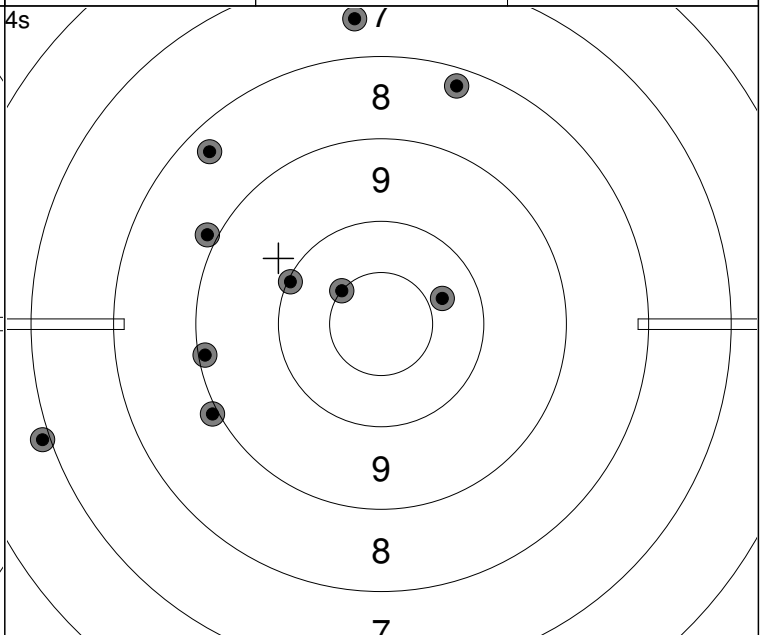
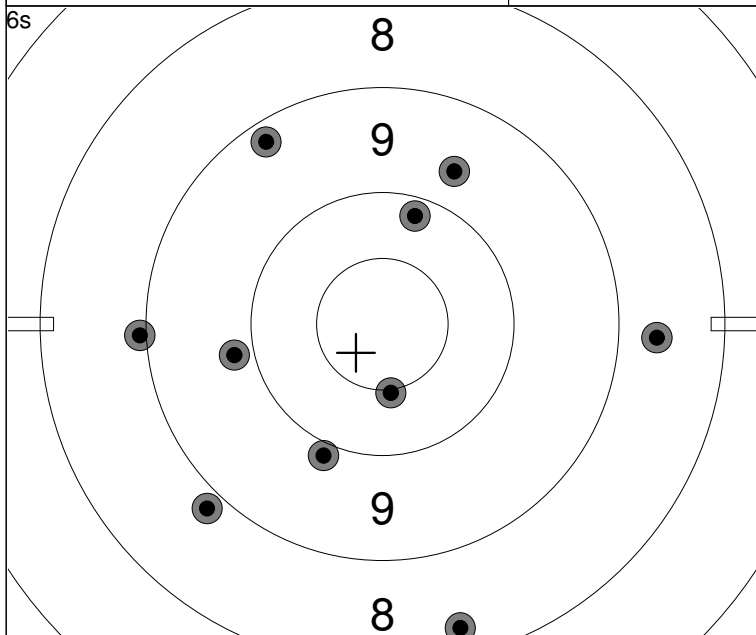

1: 1.83s 9.8 ←
2: 2.45s 9.2 ↗
3: 3.32s 10.1 ↗
4: 4.01s 8.9 ↘
5: 4.73s 10.4x ↘

1: 1.70s 9.9 ↘
2: 2.41s 9.0 ←
3: 3.04s 8.7 →
4: 3.73s 8.3 ↘
5: 4.55s 9.7 ↗

Series	89 (1x)
	168 (2x)

1: 1.57s 6.9 ←
2: 2.14s 10.0 ←
3: 2.63s 10.3 →
4: 3.08s 8.2 ↗
5: 3.55s 7.5 ↗

1: 1.52s 8.9 ←
2: 2.08s 8.3 ↗
3: 2.56s 9.0 ←
4: 3.10s 10.5x ↗
5: 3.71s 9.1 ←

Series	85 (1x)
	253 (3x)

Comment	Signature
---------	-----------

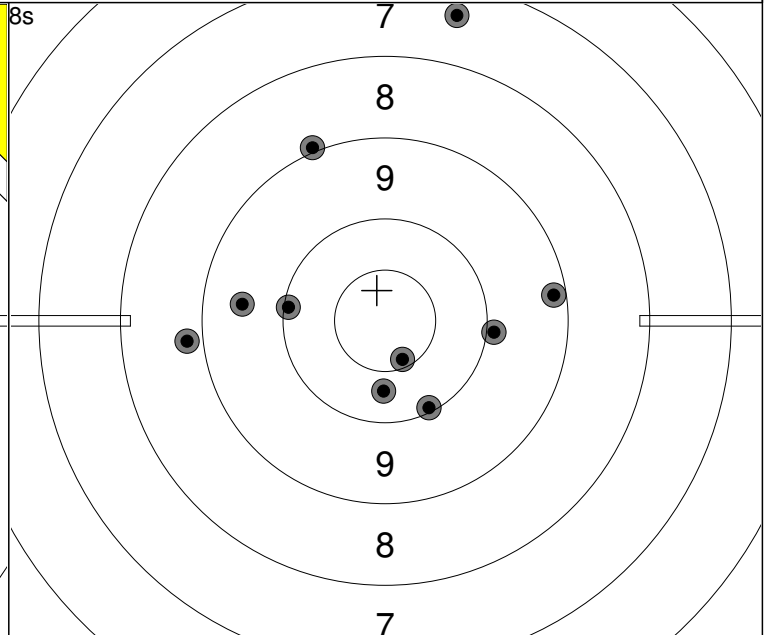
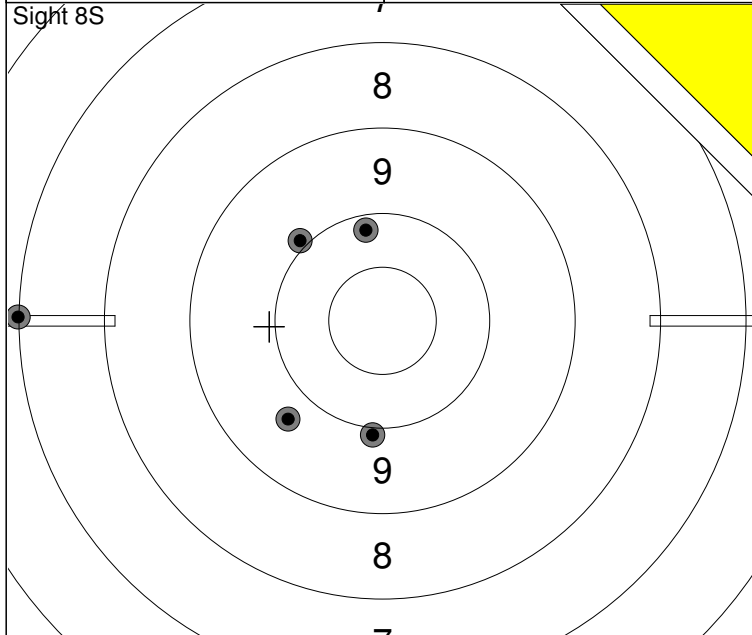

1: 1.89s	9.9	↓
2: 3.02s	10.1	↑
3: 3.81s	9.7	↙
4: 4.80s	9.9	↗
5: 5.72s	7.0	←

Series	44 (0x)
	0 (0x)

1: 2.01s	10.0	↓
2: 3.04s	9.0	↗
3: 4.03s	9.2	→
4: 5.16s	7.4	↑
5: 6.22s	10.3	↓

1: 2.50s	8.8	←
2: 3.31s	10.6x	↓
3: 4.38s	9.9	→
4: 5.23s	9.5	←
5: 5.97s	10.0	←

Series	91 (1x)
	91 (1x)

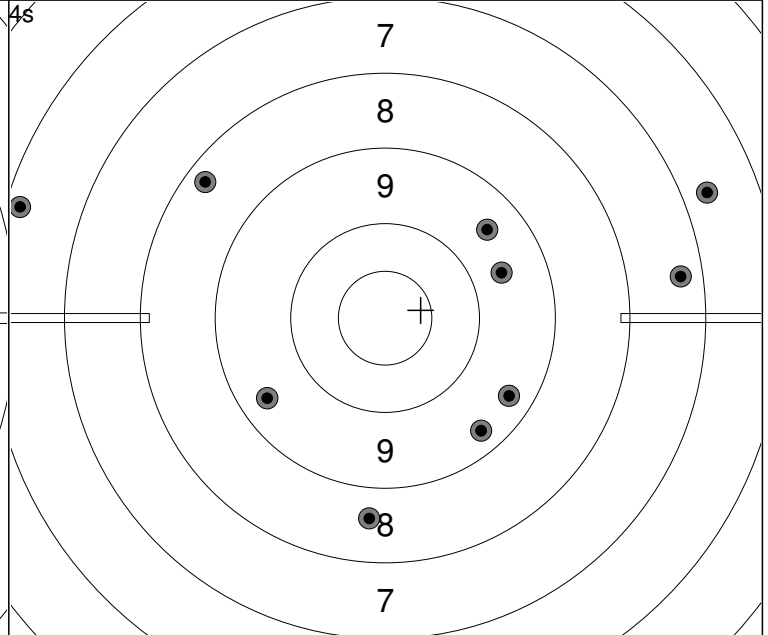
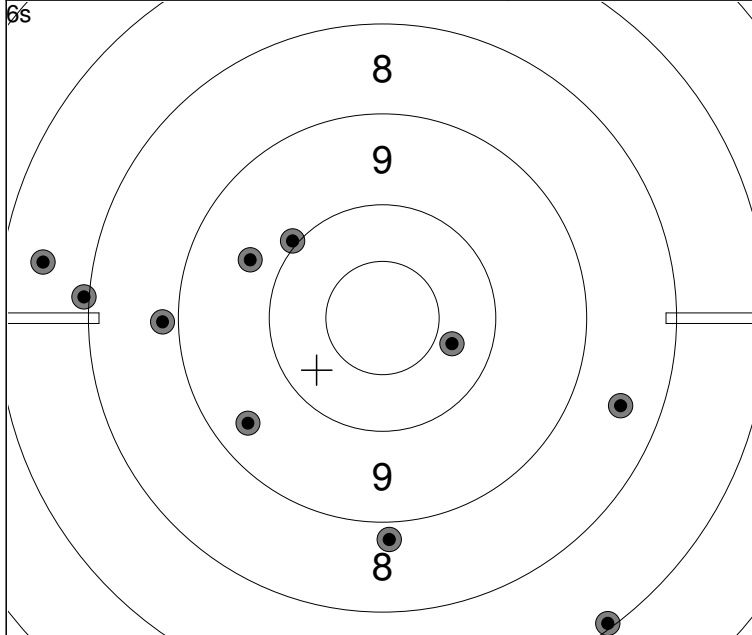

1: 1.78s	8.0	←
2: 2.44s	7.1	↓
3: 3.22s	7.5	←
4: 3.96s	9.7	↖
5: 4.65s	10.3	↗

1: 1.76s	9.4	↙
2: 2.52s	10.0	↗
3: 3.37s	8.8	↓
4: 4.19s	8.5	↗
5: 5.07s	8.8	←

Series	84 (0x)
	175 (1x)

2: 2.04s	9.6	↗
3: 2.60s	9.3	↘
4: 3.09s	6.2	←
1: 1.54s	8.6	↓
5: 3.84s	8.3	↖

1: 1.49s	9.4	↙
2: 2.02s	9.5	↗
3: 2.55s	6.7	↗
4: 3.06s	7.3	→
5: 3.55s	9.3	↘

Series	80 (0x)
	255 (1x)

Relay 3	Lane 23	MARKEWICZ Alan
-------------------	-------------------	-----------------------

2023 SFC Pistol Nationals	AB	EX	MP
---------------------------	----	----	----

13.07.2023	23PNRF1S2	Alberta Handgun Association
------------	-----------	-----------------------------

Comment	Signature
---------	-----------

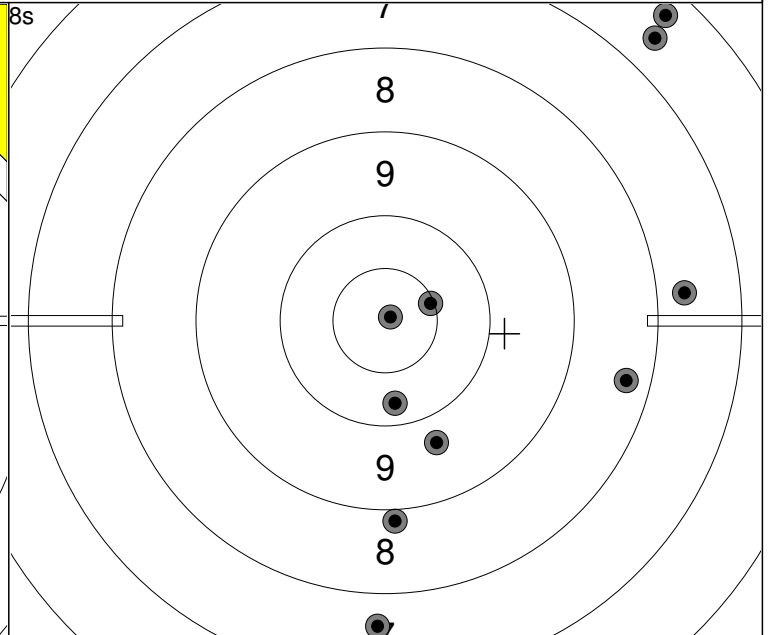
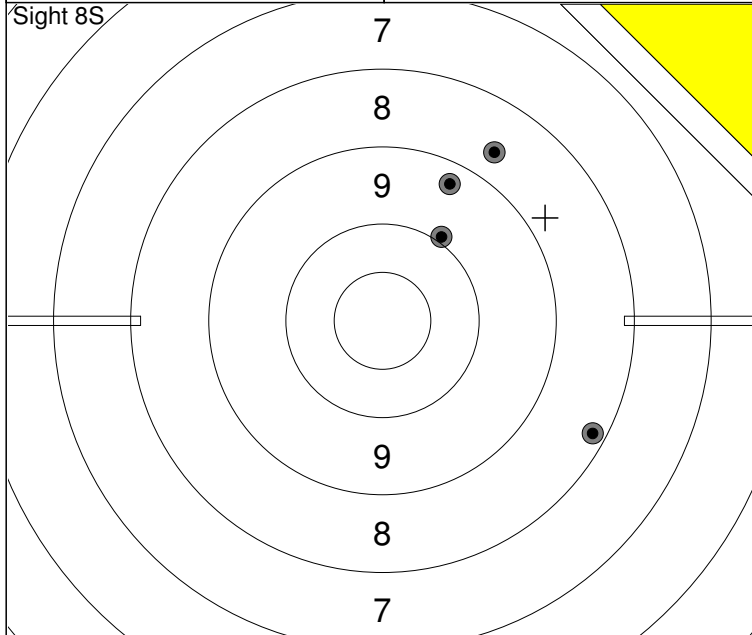

1: 2.98s 5.6 ↗
2: 4.12s 9.3 ↗
3: 5.01s 9.9 ↗
4: 6.01s 8.7 ↗
5: 7.03s 8.2 ↘

Series	39 (0x)
	0 (0x)

1: 2.74s 6.6 ↗
2: 3.75s 7.7 →
3: 4.90s 10.2 ↓
4: 5.93s 10.9x ↗
5: 6.97s 10.5x →

1: 2.19s 6.3 ↗
2: 3.03s 9.7 ↓
3: 3.83s 7.6 ↓
4: 4.78s 8.9 ↓
5: 5.58s 8.3 →

Series	81 (2x)
	81 (2x)

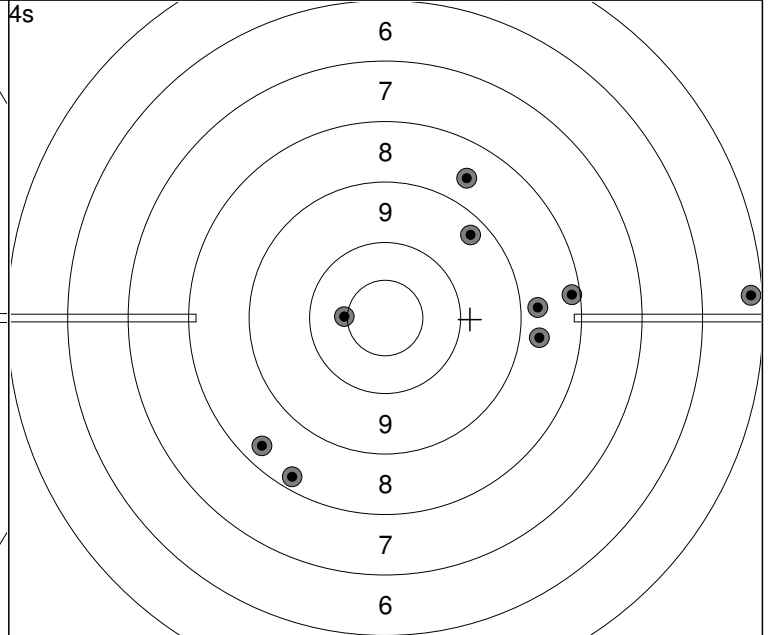
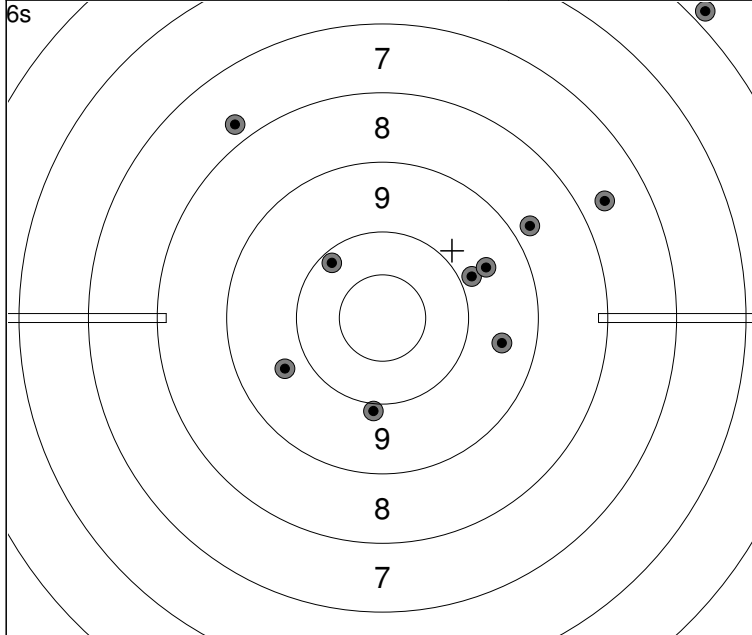

1: 1.99s 0.0 ↗
2: 2.89s 8.8 ↗
3: 3.66s 9.9 ↓
4: 4.37s 7.6 ↗
5: 5.18s 9.8 ↗

1: 1.90s 9.6 ↗
2: 2.79s 9.5 →
3: 3.60s 10.1 ↗
4: 4.31s 7.8 ↗
5: 5.21s 9.7 ↙

Series	77 (0x)
	158 (2x)

1: 1.74s 8.3 ↙
2: 2.30s 8.2 →
3: 2.94s 9.3 ↗
4: 3.43s ☒
5: 4.04s 5.2 →

1: 1.68s 8.7 →
2: 2.22s 8.2 ↙
3: 2.96s 8.7 →
4: 3.63s 8.6 ↗
5: 4.18s 10.4x ←

Series	72 (1x)
	230 (3x)